

Mounting Kit for Ethernet Switch

FPM-5000-KES



BOSCH

cs Instalační příručka
de Installationsanleitung
el Εγχειρίδιο εγκατάστασης
en Installation Guide
es Guía de instalación
fr Guide d'installation
hr Instalacijske upute
hu Telepítési útmutató

it Guida all'installazione
nl Installatiehandleiding
en Instrukcja instalacji
pt Manual de instalação
ro Ghid de instalare
ru Руководство по установке
sl Priročnik za namestitev
tr Kurulum Kılavuzu

cs	Instalační příručka	4
de	Installationsanleitung	4
el	Εγχειρίδιο εγκατάστασης	4
en	Installation Guide	5
es	Guía de instalación	5
fr	Guide d'installation	5
hr	Instalacijske upute	6
hu	Telepítési útmutató	6
it	Guida all'installazione	6
nl	Installatiehandleiding	7
en	Instrukcja instalacji	5
pt	Manual de instalação	7
ro	Ghid de instalare	7
ru	Руководство по установке	8
sl	Priročnik za namestitev	8
tr	Kurulum Kılavuzu	8

CS**NEBEZPEČÍ!**

Součásti pod napětím a odizolovaný kabel! Nebezpečí úrazu elektrickým proudem. Během připojování nesmí být systém pod napětím.

**NEBEZPEČÍ!**

Laserová radiace, laserový produkt třídy 2M. Nedívejte se do paprsku. Přímou se nedívejte ani přes optické prostředky!

**POZNÁMKA!**

Podrobné informace o připojení konvenčních ústředěn k síti prostřednictvím rozhraní CAN a Ethernet naleznete v Průvodci připojením k síti, který je k dispozici ke stažení na webových stránkách www.boschsecurity.com.

de**GEFAHR!**

Stromführende Bauteile und abisolierte Kabel! Verletzungsgefahr durch Stromschlag. Bei Anschlussarbeiten muss die Anlage spannungslos sein.

**GEFAHR!**

Laserstrahlung, Laserprodukt Klasse 2M. Nicht in den Strahl blicken oder mit optischen Instrumenten direkt betrachten!

Sowohl beim Einsatz des Ethernet Switch F.01U.267.019 (RSR20-0800S2S2T) oder F.01U.258.204 (BPA-ESW-RSR20) in einem USF 0000 A Gehäuse als auch beim Einsatz des Medienkonverters F.01U.265.643 (EL1141-B0B-BH) oder F.01U.265.641 (EL1141-10B-BH) in einem USF 0000 A oder einem PSS 0002 A Gehäuse gilt:

**VORSICHT!**

Dies ist eine Einrichtung der Klasse A. Diese Einrichtung kann im Wohnbereich Funkstörungen verursachen. In diesem Fall kann vom Betreiber verlangt werden, angemessene Maßnahmen durchzuführen.

**HINWEIS!**

Genauere Informationen zur CAN- und Ethernet-Vernetzung der Brandmelderzentralen finden Sie im Handbuch zur Vernetzung. Es kann unter www.boschsecurity.com heruntergeladen werden.

el**ΚΙΝΔΥΝΟΣ!**

Εξαρτήματα με ηλεκτρική τάση και γυμνά καλώδια! Κίνδυνος τραυματισμού από ηλεκτροπληξία. Στο σύστημα δεν πρέπει να υπάρχει τάση κατά τη διάρκεια εργασιών σύνδεσης.

**ΚΙΝΔΥΝΟΣ!**

Ακτινοβολία λέιζερ, προϊόν λέιζερ κλάσης 2M. Μην κοιτάζετε τη δέσμη και μην την παρατηρείτε απευθείας με οπτικά όργανα!

**ΣΗΜΕΙΩΣΗ!**

Θα βρείτε λεπτομερείς πληροφορίες σχετικά με τη δικτύωση CAN και Ethernet στους πίνακες πυροπροστασίας στον Οδηγό δικτύωσης, διαθέσιμες για λήψη στο www.boschsecurity.com.

en**DANGER!**

Live components and stripped cable! Risk of injury from electric shock. The system must be voltage-free during connection work.

**DANGER!**

Laser radiation, class 2M laser product. Do not stare into the beam or view directly with optical instruments!

If the Ethernet switch F.01U.267.019 (RSR20-0800S2S2T) or F.01U.258.204 (BPA-ESW-RSR20) is installed in the USF 0000 A housing, or the media converter F.01U.265.643 (EL1141-B0B-BH) or F.01U.265.641 (EL1141-10B-BH) is installed in the USF 0000 A or PSS 0002 A housing, the following applies:

**CAUTION!**

This is a class A device. This device may cause radio interferences. In this case, the operator can be asked to take appropriate actions.

**NOTICE!**

You will find detailed information about the CAN and Ethernet networking of the fire panels in the Networking Guide available for download at www.boschsecurity.com.

es**¡PELIGRO!**

Componentes cargados y cables desnudos. Riesgo de descargas eléctricas. El sistema debe estar desconectado de la corriente durante el proceso de instalación.

**¡PELIGRO!**

Producto láser de clase 2M, radiación láser. No mire directamente el haz láser ni lo haga tampoco a través de algún instrumento óptico

**¡NOTA!**

Encontrará información detallada acerca de CAN y red Ethernet de las centrales de incendio en la Guía de funcionamiento en red disponible para su descarga en www.boschsecurity.com.

fr**DANGER !**

Composants sous tension et câbles dénudés. Risque de blessures par choc électrique. Assurez-vous que l'alimentation électrique est coupée lorsque vous effectuez les branchements de l'appareil.

**DANGER !**

Rayonnement laser, produit laser de classe 2M. Ne fixez pas le faisceau et ne l'examinez pas directement au moyen d'instruments optiques.

**REMARQUE !**

Pour plus d'informations concernant le fonctionnement en réseau CAN et Ethernet des centrales incendie, consultez le guide du fonctionnement en réseau (Networking Guide) disponible en téléchargement sur : www.boschsecurity.com.

hr**OPASNOST!**

Komponente pod naponom i neizolirani kabel! Opasnost od tjelesnih povreda uslijed strujnog udara. Sustav ne smije biti pod naponom tijekom radova na priključivanju.

**OPASNOST!**

Lasersko zračenje, laserski proizvod klase 2M. Nemojte zuriti u svjetlosni snop niti ga izravno promatrati optičkim instrumentima!

**NAPOMENA!**

Detaljne informacije o CAN i Ethernet umrežavanju upravljačke ploče sustava za dojavu požara nalaze se u uputama za umrežavanje dostupnima za preuzimanje s web-stranice www.boschsecurity.com.

hu**FIGYELEM!**

Feszültség alatti alkatrészek és csupasz kábel! Áramütésveszély. A rendszer a vezetékszerelési munkálatok során ne legyen feszültség alatt.

**FIGYELEM!**

Lézersugárzás, 2M osztályú lézer termék. Ne nézzen közvetlenül a sugárba vagy vizsgálja közvetlenül optikai eszközökkel!

**FIGYELEM!**

A tűzjelző központok CAN és Ethernet hálózatba kapcsolásáról részletes tájékoztatást talál a hálózatba kapcsolási útmutatóban (letölthető a www.boschsecurity.hu oldalon).

it**PERICOLO!**

Componenti sotto tensione e cavo scoperto. Rischio di scosse elettriche. Il sistema non deve essere collegato alla presa di corrente durante le operazioni di installazione.

**PERICOLO!**

Prodotto laser di classe 2M in grado di produrre emissioni di radiazioni. Non rivolgere lo sguardo verso il fascio o guardarlo direttamente con apparecchi ottici.

**NOTA!**

Informazioni più dettagliate sul collegamento in rete CAN ed Ethernet delle centrali di rivelazione incendio sono disponibili nella guida per il collegamento in rete scaricabile all'indirizzo www.boschsecurity.com.

nl**GEVAAR!**

Spanningvoerende onderdelen en gestripte kabel! Gevaar voor letsel door elektrische schok. Het systeem moet spanningsloos zijn tijdens het aansluiten.

**GEVAAR!**

Laserstraal, laserproduct van klasse 2M. Niet in de straal kijken of deze rechtstreeks bekijken met optische instrumenten!

**AANWIJZING!**

In de Netwerk Guide die gedownload kan worden op www.boschsecurity.nl vindt u gedetailleerde informatie over het gebruik van de brandmeldcentrales in CAN- en Ethernet-netwerken.

pl**DANGER!**

Elementy pod napięciem i odizolowane kable! Ryzyko porażenia prądem elektrycznym! Na czas prac instalacyjnych system należy odłączyć od zasilania.

**DANGER!**

Promieniowanie laserowe, produkt laserowy klasy 2M. Nie należy kierować wzroku na wiązkę promieniowania ani obserwować jej za pomocą przyrządów optycznych!

**NOTICE!**

Szczegółowe informacje na temat połączeń sieciowych CAN i Ethernet w centralach sygnalizacji pożaru można znaleźć w instrukcji połączeń sieciowych dostępnej do pobrania na stronie www.boschsecurity.com.

pt**PERIGO!**

Componentes com corrente e cabo descarnado! Risco de lesões devido a choque eléctrico. O sistema não pode ter alimentação eléctrica durante os trabalhos de ligação.

**PERIGO!**

Produto emissor de radiação laser com laser de classe 2M. Não olhe directamente para o feixe nem utilize quaisquer instrumentos ópticos!

**NOTA!**

Poderá encontrar informações detalhadas sobre a ligação em rede CAN e Ethernet dos painéis de incêndio no manual de ligação em rede disponível para download em www.boschsecurity.com.pt.

ro**PERICOL!**

Componente sub tensiune și cablu neizolat! Pericol de electrocutare. Sistemul nu trebuie să fie sub tensiune electrică în timpul operațiilor de conectare.

**PERICOL!**

Radiație laser, produs laser clasa 2M. Nu priviți direct în fascicul sau direct, cu ajutorul unor instrumente optice!

**INDICATIE!**

Puteți găsi informații detaliate despre conectarea în rețea CAN și Ethernet a panourilor de detecție a incendiilor în Ghidul de Conectare în Rețea pe care îl puteți descărca de la www.boschsecurity.com.

ru**ОПАСНОСТЬ!**

Оголенные провода и компоненты под напряжением! Опасность поражения электрическим током! Во время работ по подключению система должна быть обесточена.

**ОПАСНОСТЬ!**

Лазерное излучение. Лазерное изделие класса 2M. Запрещается смотреть на источник лазерного луча, в том числе с использованием оптических инструментов!

**ЗАМЕЧАНИЕ!**

Подробные сведения о сетевых функциях CAN и Ethernet пожарных панелей приведены в Руководстве по работе в сети, который можно загрузить с веб-сайта www.boschsecurity.com.

sl**NEVARNOST!**

Komponente pod napetostjo in nezaščiten kabl! Nevarnost poškodb zaradi električnega udara. Med priključnimi deli mora biti napajanje sistema izklopljeno.

**NEVARNOST!**

Sevanje laserja, razred laserja 2M. V žarek ne strmite ali ga neposredno glejte z optičnimi pripomočki!

**OPOMBA!**

Podrobne informacije o povezavi protipožarnih plošč z omrežjem z vmesnikom CAN in ethernet so v priročniku za povezavo z omrežjem, ki si ga lahko prenesete s spletnega mesta www.boschsecurity.com.

tr**TEHLİKE!**

Elektrik yüklü parçalar ve çıplak kablo! Elektrik çarpması sonucu yaralanma tehlikesi. Bağlantı işlemleri yapılırken sistemde gerilim olmamalıdır.

**TEHLİKE!**

Lazer radyasyonlu, sınıf 2M lazer ürünü. Işının içine doğru bakmayın veya optik araçlarla doğrudan izlemeyin!

**NOT!**



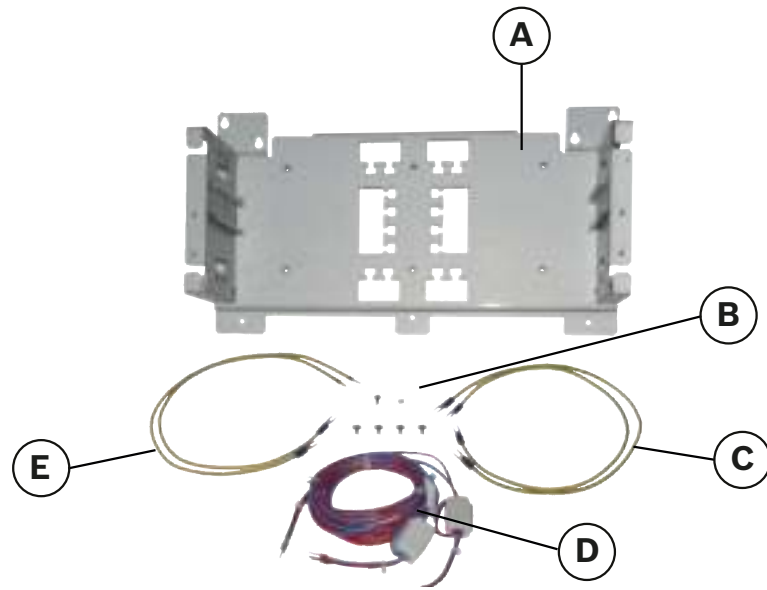
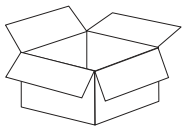



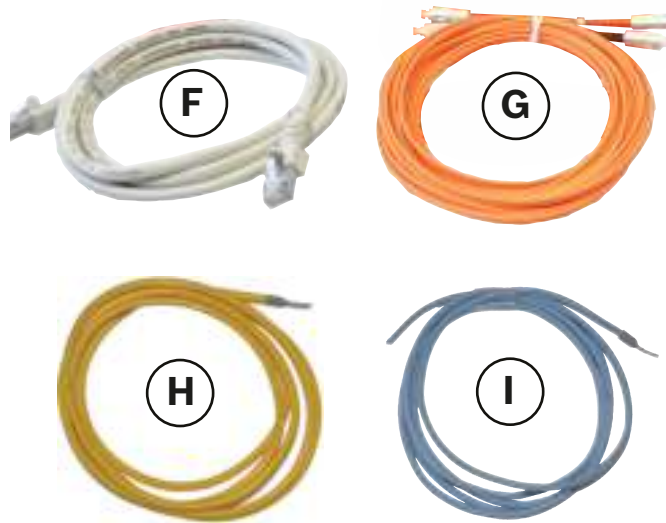



Yangın panellerinin CAN ve Ethernet ağı hakkında ayrıntılı bilgiyi www.boschsecurity.com adresinden indirebileceğiniz Networking Guide (Ağ Kılavuzu) belgesinde bulabilirsiniz.

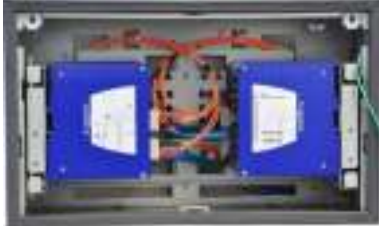

A	Bracket for Ethernet Switch [Media Converter]	D	ES / MC -> BCM V- V+
B	M4 x 5 (4x), M3 x 6 (1x)	E	⊕ Media Converter (2x)
C	⊕ Ethernet Switch (2x)		

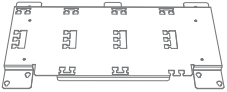

F	Ethernet Patch-Cable, shielded CAT5e or better	2 x RJ-45
G	Fiber Optic Ethernet Patch-Cable Multi Mode: Duplex I-VH2G 50/125μ Single-Mode: Duplex I-VH2E 9/125μ	2 x SC-Connector
H	Trouble IN (see Networking Guide)	0.75 mm ²
I	Trouble GND (see Networking Guide)	0.75 mm ²

<p>PSS 0002 A</p> 	2 x MC		--> MPC-xxxx-C --> FMR-5000-C
	2 x ES		--> MPC-xxxx-C
	1 x MC + 1 x ES		--> MPC-xxxx-C
<p>USF 0000 A</p>    	2 x MC		--> MPC-xxxx-C --> FMR-5000-C
	2 x ES		--> MPC-xxxx-C
	1 x MC + 1 x ES		--> MPC-xxxx-C

1

 3 x M4 x 5mm

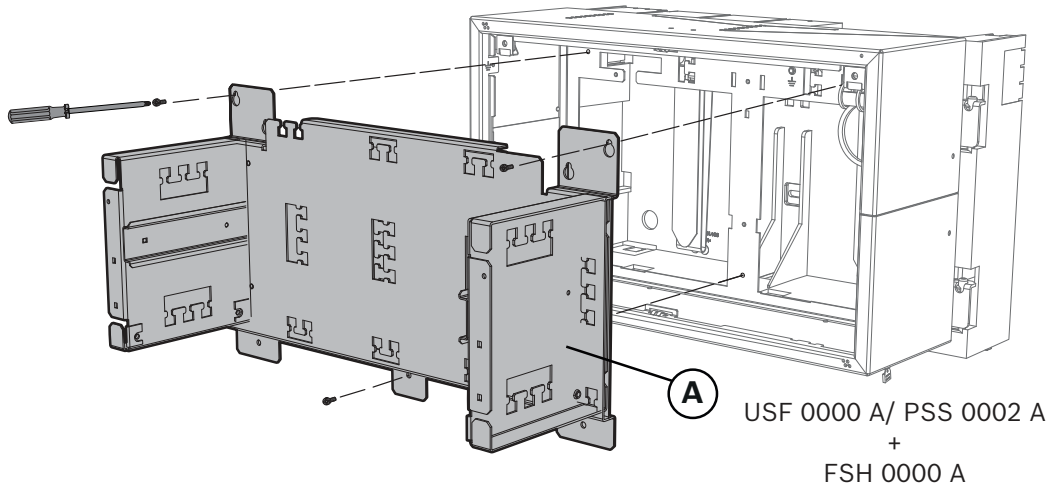

2

MPC-xxxx-C

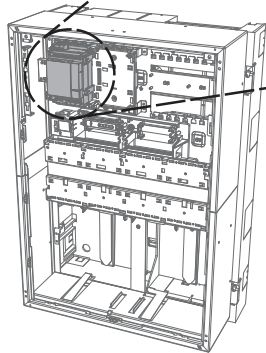
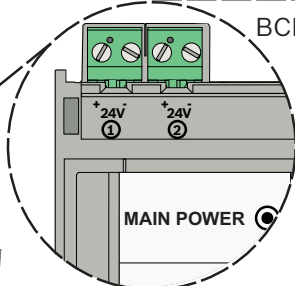

FBH 0000 A/ FHS 0000 A +
CPH 0006 A/ MPH 0010 A

2

FMR-5000-C

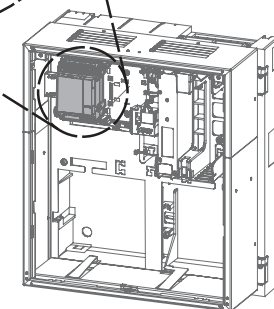
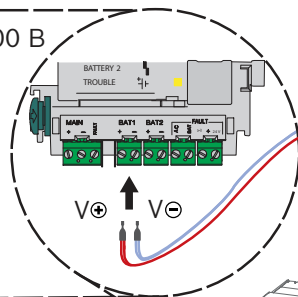
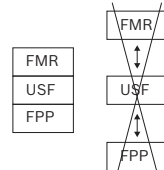

FPP-5000

3 BCM 0000 B → MPC-xxxx-C

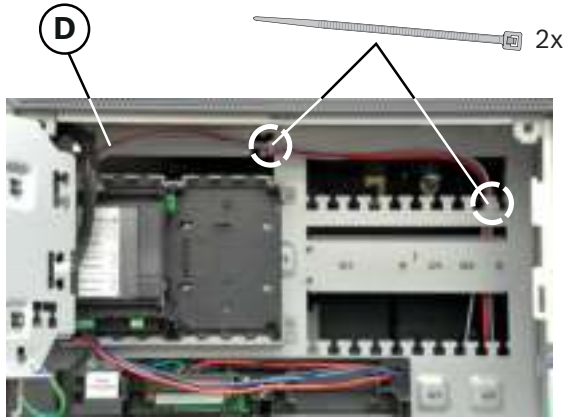

3 BCM 0000 B → FMR-5000-C



4 MPC-xxxx-C

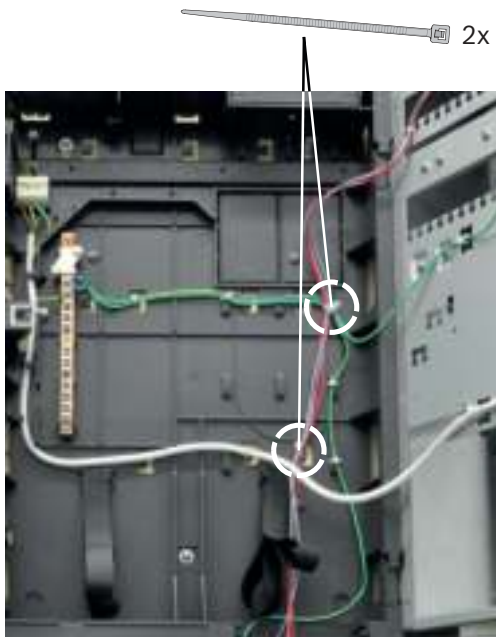

4 FMR + FPP-5000

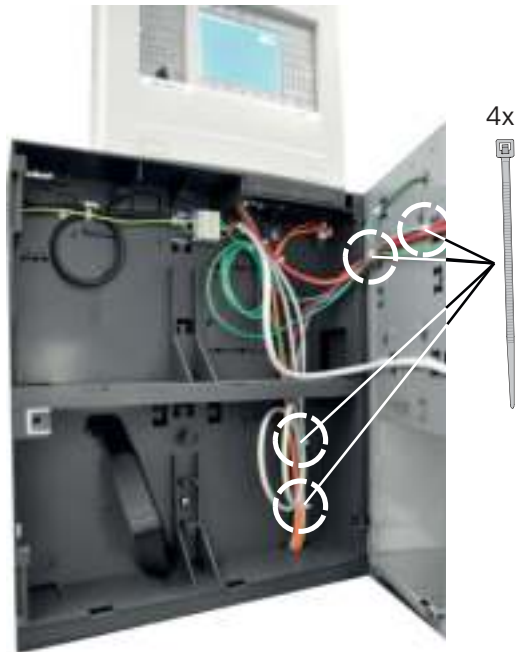

5 MPC-xxxx-C, FMR-5000-C

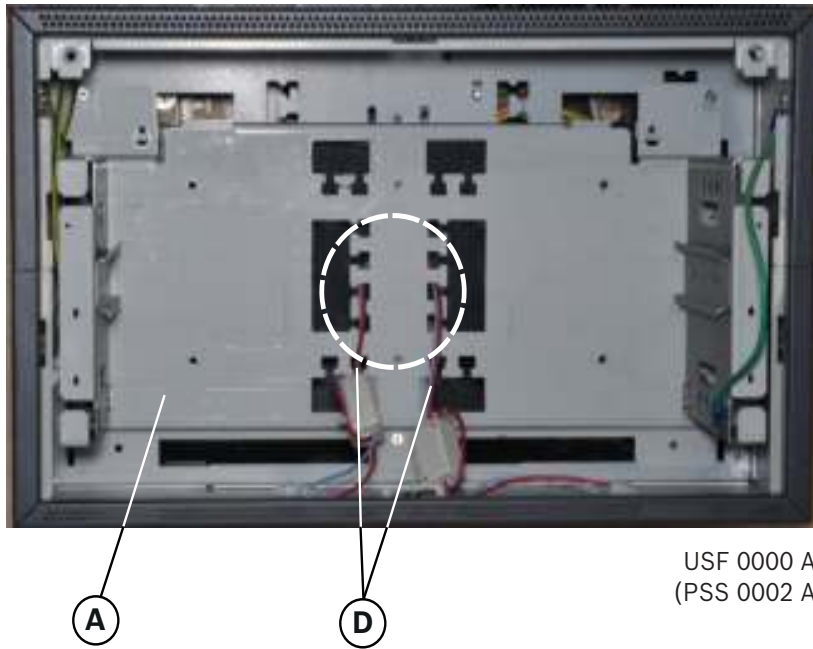

6 ES → MPC-xxxx-C

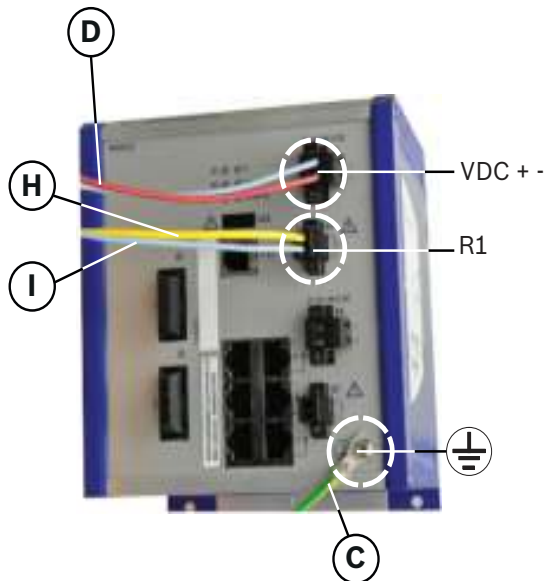

6 MC → MPC-xxxx-C/ FMR-5000-C



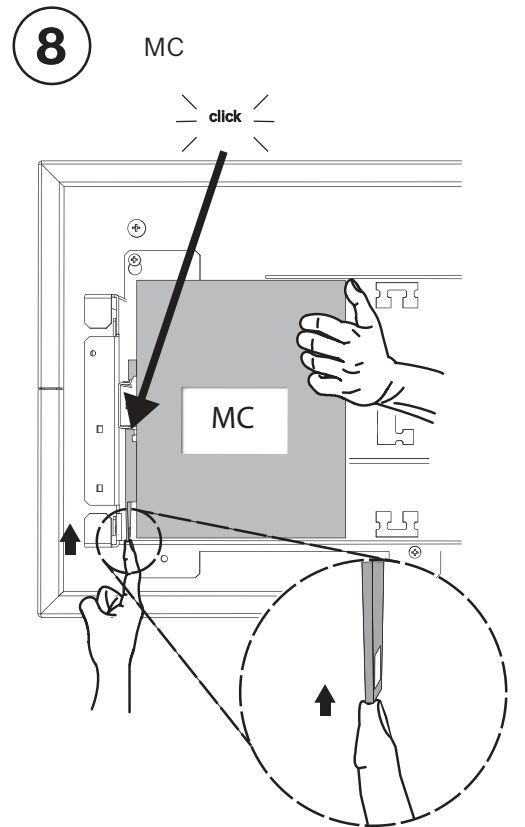
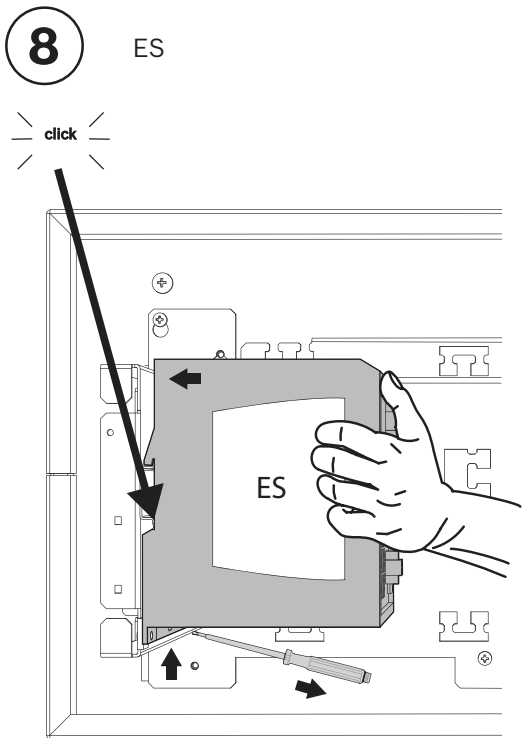
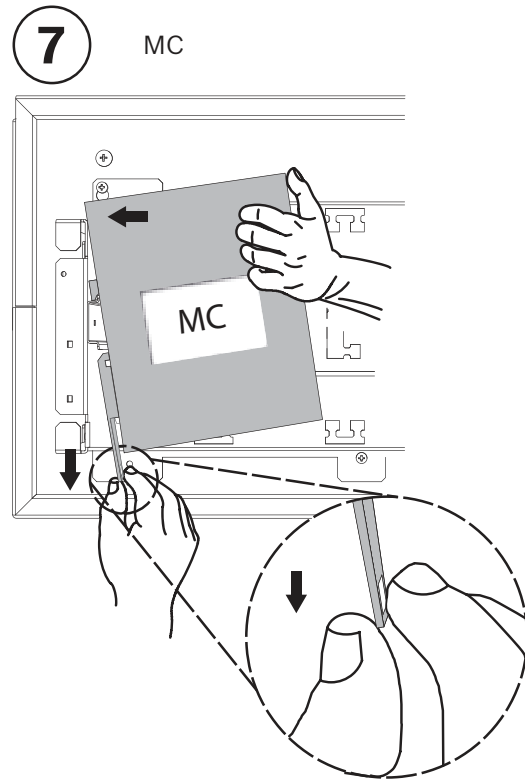
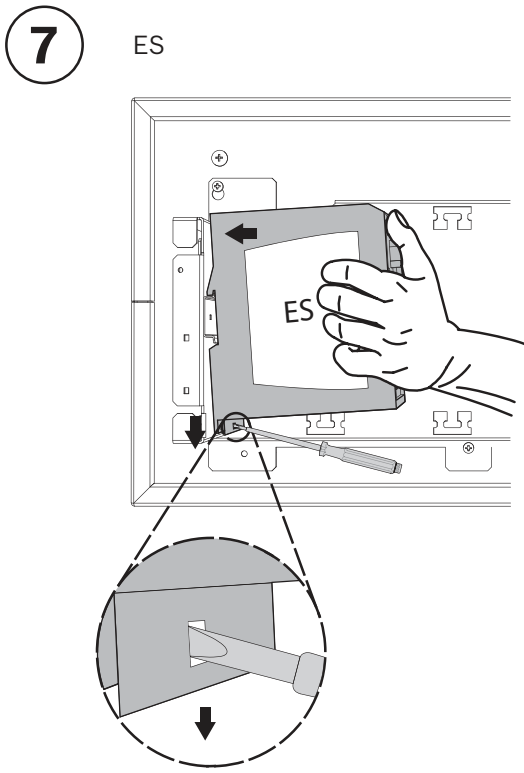

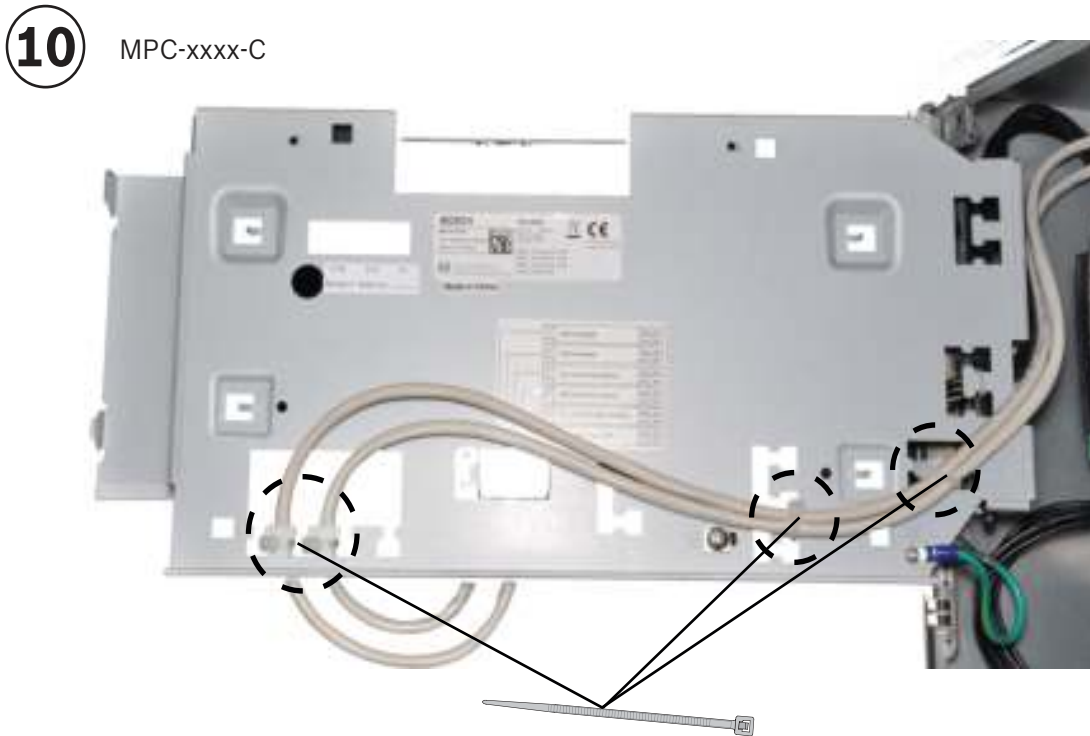
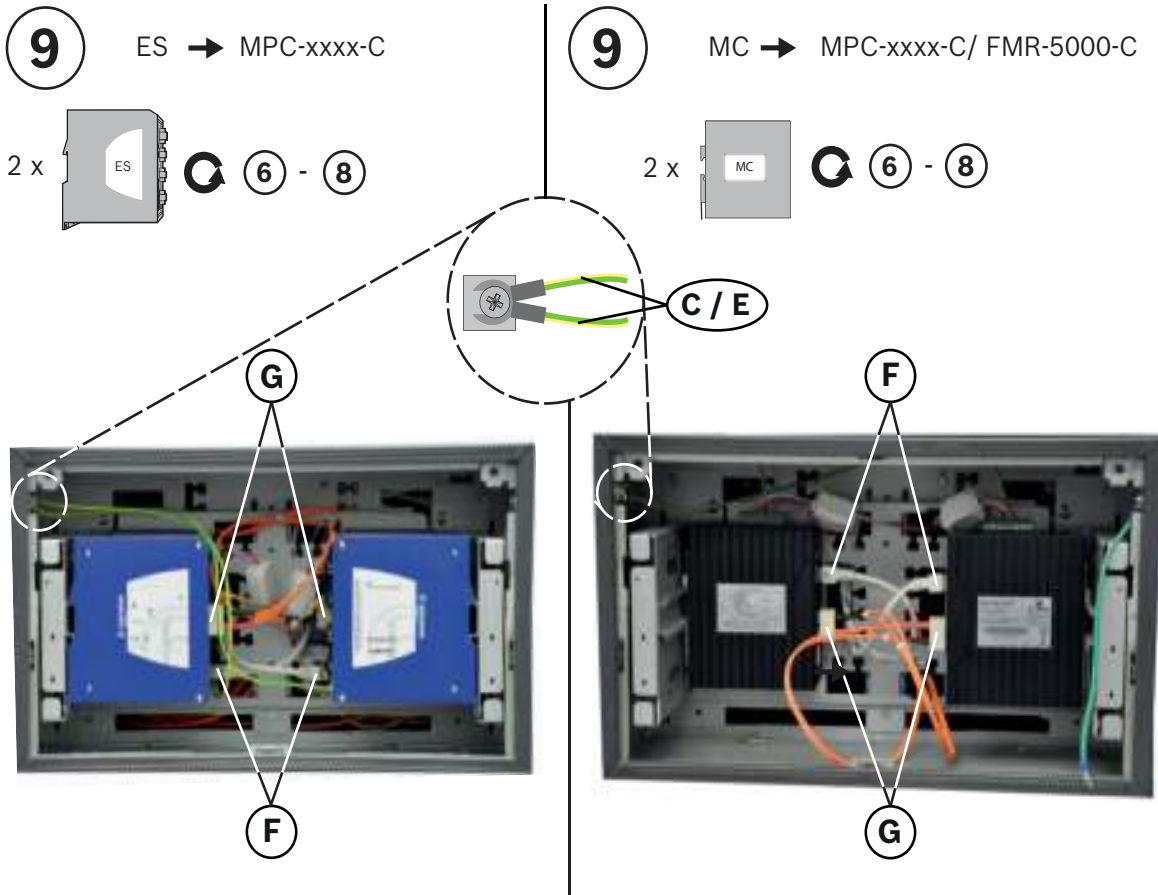

11 MPC-xxxx-C/ FMR-5000-C

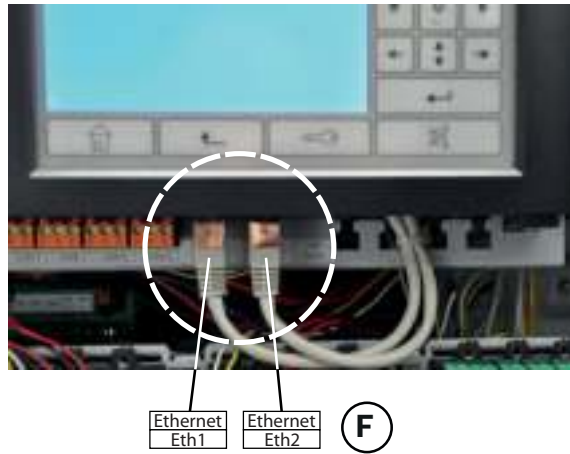

12.1 ES → MPC-0000-C

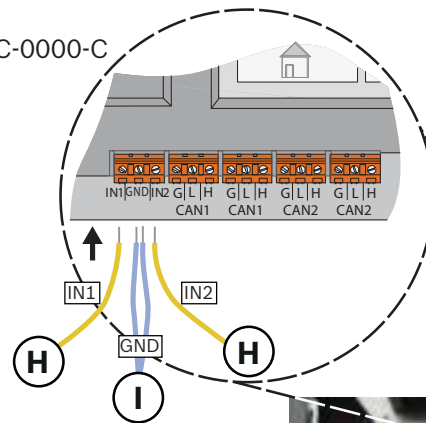

12.2 ES → IOP 0008 A

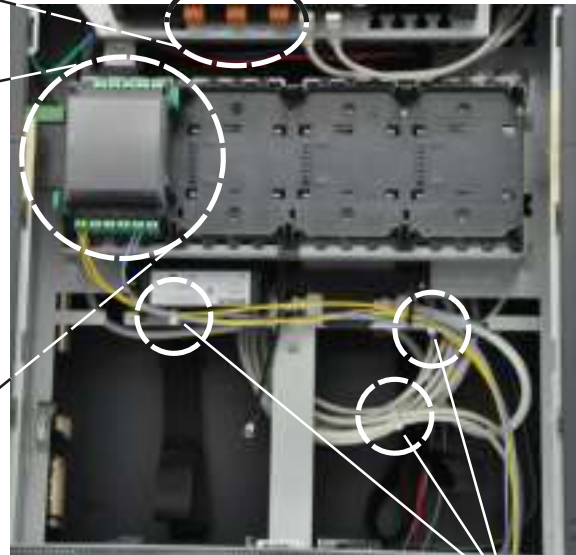
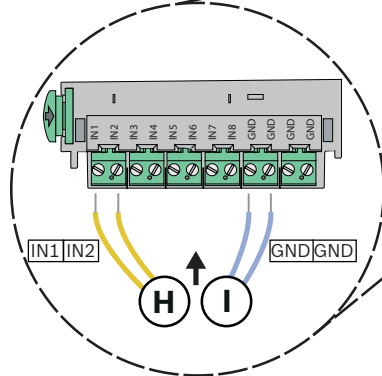

3x

Bosch Sicherheitssysteme GmbH

Robert-Bosch-Ring 5

85630 Grasbrunn

Germany

www.boschsecurity.com

© Bosch Sicherheitssysteme GmbH, 2012