

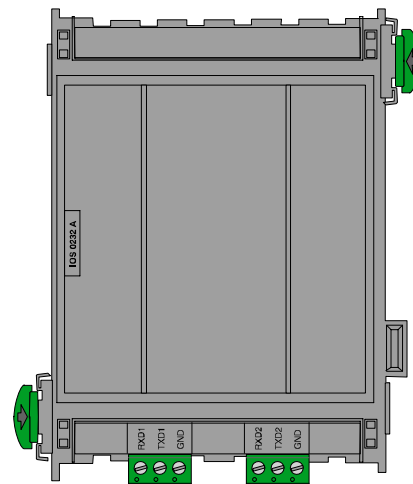

IOS 0232 A

4.998.137.267



- AL** **Pershkrimi i pajisjes / Manual i instalimit**
RS232 Moduli i komunikimit
- BG** **Описание на продукта / Инструкция за монтаж**
RS232 Комуникационен модул
- CZ** **Popis produktu / Instalační manuál**
Komunikační modul IOS 0232 A RS232
- D** **Produktbeschreibung / Montageanleitung**
Serielles Schnittstellenmodul RS232
- DK** **Produktbeskrivelse / Installationsmanual**
RS232 Kommunikationsmodul
- E** **Descripción del Producto / Manual de Instalación**
RS232 Módulo de comunicación
- EST** **Toote kirjeldus / Monteerimisjuhised**
RS232 Ühendusmodul
- F** **Description de produit / Manuel d'installation**
Module de communication RS232
- FIN** **Tuotekuvaus / Asennusohjeet**
RS232-tiedonsiirtomoduuli
- GB** **Product description / Installation manual**
RS232 Communication module
- GR** **Περιγραφή προϊόντος / Οδηγίες συναρμολόγησης**
Δομοστοιχείο επικοινωνίας RS232
- H** **Termékleírás / Telepítési kézikönyv**
RS232 kommunikációs modul
- HR** **Opis proizvoda / Priručnik za instaliranje**
RS232 komunikacijski modul
- I** **Descrizione prodotto / Manuale di installazione**
Modulo di comunicazione RS232
- LT** **Gaminio aprašymas / Surinkimo instrukcija**
RS232 komunikacinis modulis
- LV** **Izstrādājuma apraksts / Montāžas norādījumi**
RS232 komunikāciju modulis
- N** **Produktbeskrivelse / Monteringsinstruksoner**
RS232 kommunikasjonsmodul
- NL** **Productomschrijving / Installatiehandleiding**
RS232 communicatiemodules
- P** **Descrição de Produto / Manual de Instalação**
Módulo de comunicações RS232
- PL** **Opis produktu / Instrukcja instalacji**
Moduł komunikacyjny RS232
- RO** **Prospecte / Manual de Instalara**
Modul de comunicare RS232
- RUS** **Техническое описание / Инструкция по установке**
Коммуникационный модуль RS232
- S** **Produkt beskrivning / Installation manual**
RS232 kommunikationsmodul
- SCG** **Opis proizvoda / Instalacijski priručnik**
RS232 komunikacijski modul
- SLO** **Opis izdelka / Priročnik za montažo**
RS232 Komunikacijski modul
- TR** **Ürün tanımı / Kurulum kılavuzu**
RS232 İletişim modülü



IOS 0232 A ⇒ PRS 0002 A / PRD 0004 A

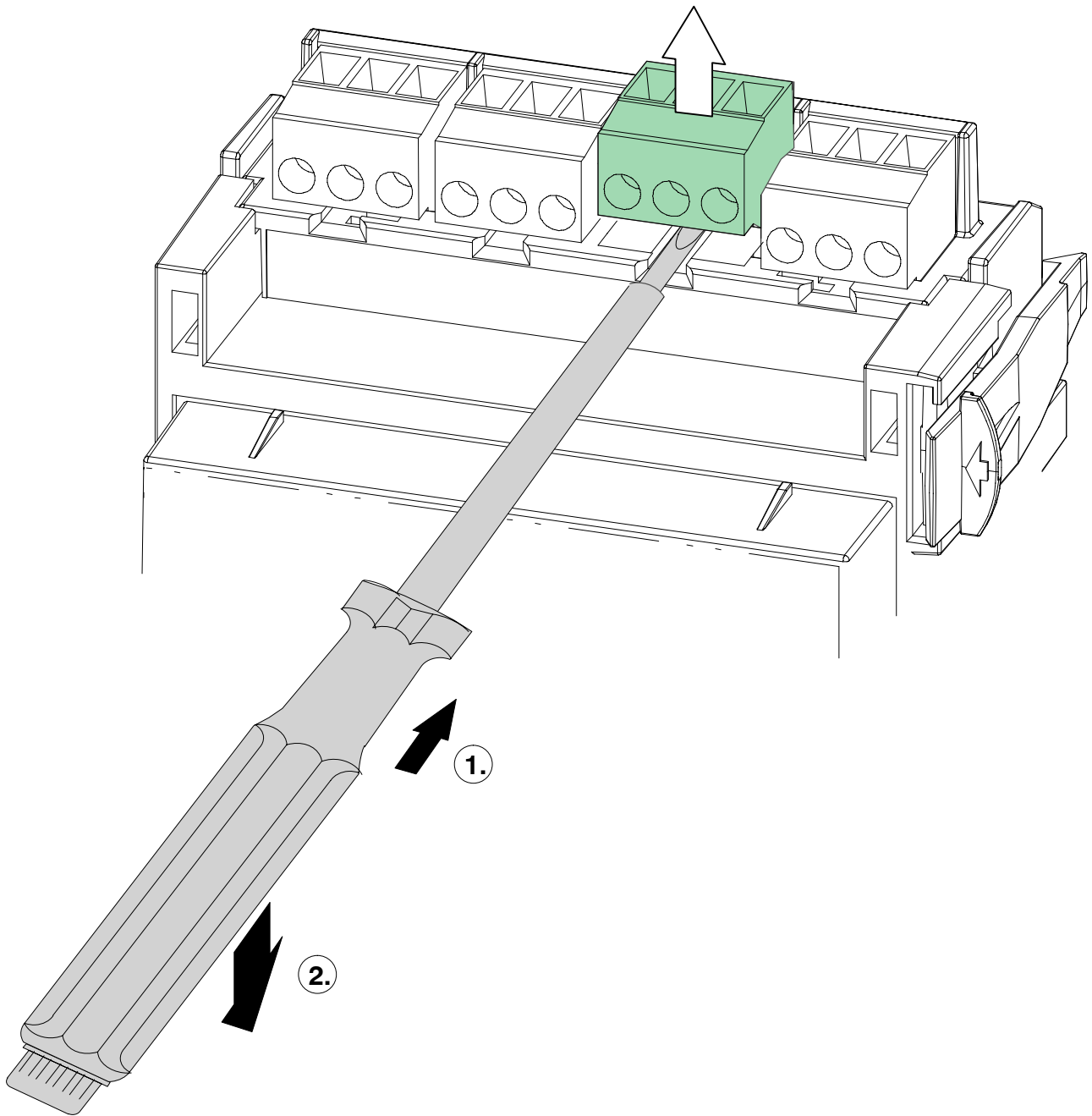

BOSCH

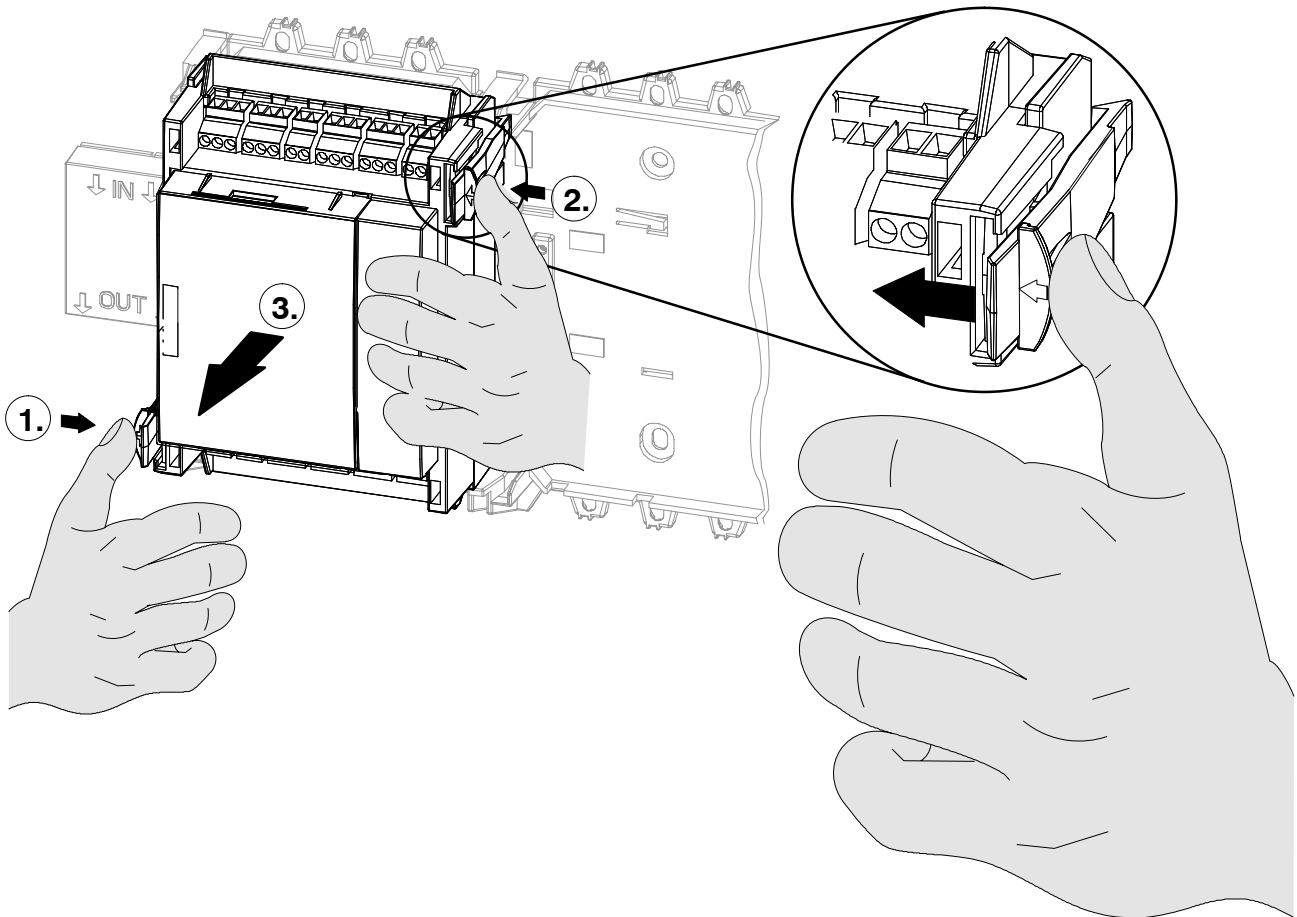
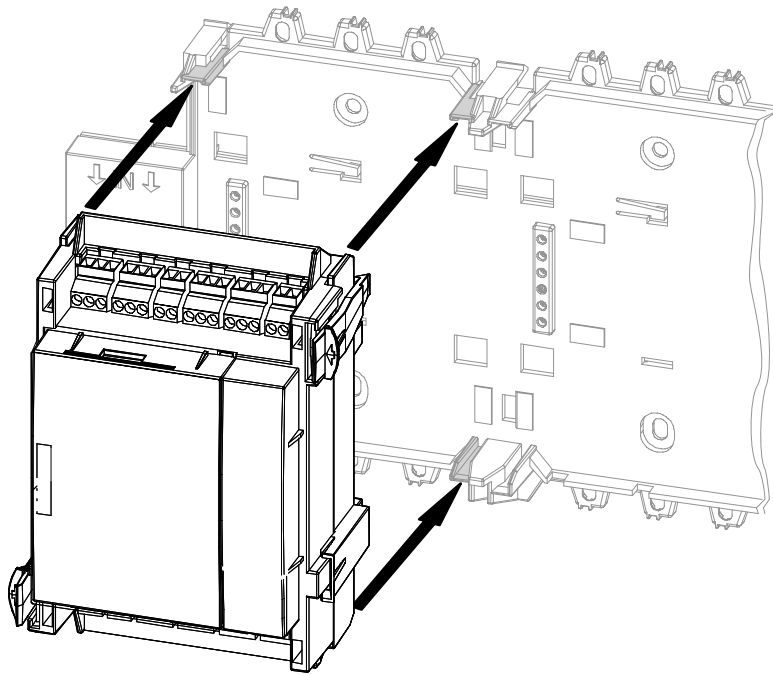

Përshkrimi i funksioneve

- Moduli i komunikimit RS232 jep dy interfaqe të pavarura RS232 për të lidhur një makinë shtypi (printer) dhe/ose një Laptop (kompjuter portativ).

Rrjeti

Poz.	Marka	Lidhje
15	RXD1	RS232 Interfaqja 1
16	TXD1	
17	GND	
20	RXD2	RS232 Interfaqja 2
21	TXD2	
22	GND	

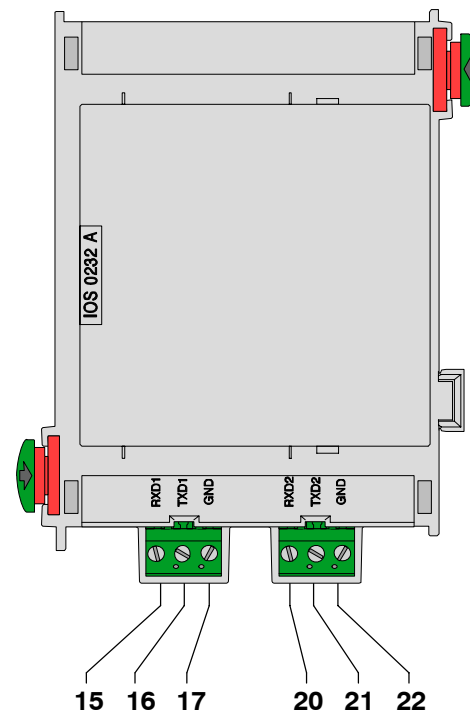

Caktimi-pin i plug-ut DSUB 9-pin

PIN-No.	Lidhje
2	TxD0
3	RxD0
5	GND

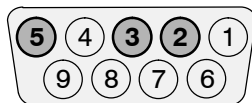

Karakteristika teknike

Tensioni i hyrjes (min. - max.)	20 mA në 24 V DC
Konsumi maksimal i rrymës	2,6 mA
Gjatësia maksimale e linjave	3 m (3,28 jard) për çdo interfaqe
Klasa e sigurisë	IEC 60950 / EN 60950
Mbrojtja EMI / EMC	EN 50081-1 / FCC Part 15
Klasa e mbrojtjes	IP 30 si për IEC 60529
Temperatura e lejueshme e funksionimit	-5 °C ... 50 °C (23 °F ... 122 °F)
Temperatura e lejueshme e magazinimit	-20 °C ... 60 °C (-4 °F ... 140 °F)
Lagështia relative e lejueshme	max. 95% nuk kondenson
Materiali dhe ngjyra e folesë	ABS plastik Polylak PA-766 (UL94 V-0), antracit gjysëm i shndritshëm, RAL 7016
Dimensionet (Lart. x Gjer. x Gjat.)	përafërsisht 127 x 96 x 60 mm (7,9 x 3,9 x 1,6 inç)
Pesha	përafërsisht 180 g (6,3 oncë)

Функционално описание

- Комуникационният модул за RS232 предоставя два независими интерфейса RS232 за свързване на принтер и/или лаптоп.

Електрическа монтажна схема

Поз.	Означение	Свързване
15	RXD1	Интерфейс RS232 1
16	TXD1	
17	GND	
20	RXD2	Интерфейс RS232 2
21	TXD2	
22	GND	

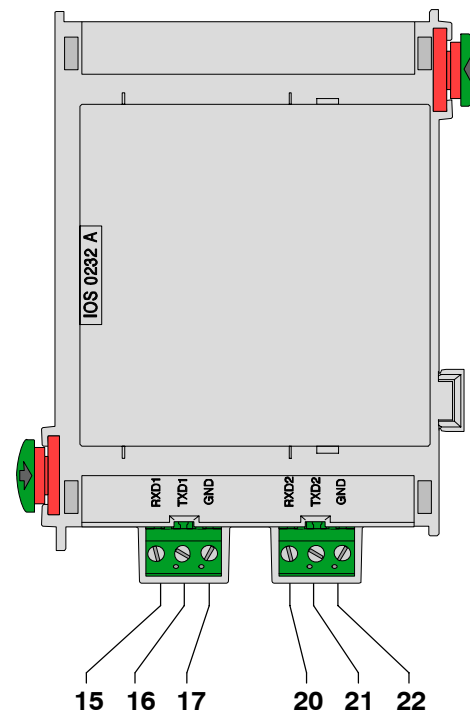

Предназначение на крачетата на 9-изводен щепсел DSUB

Краче №	Свързване
2	TxD0
3	RxD0
5	GND

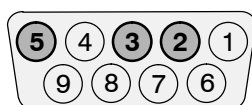

Техническа спецификация

Входно напрежение (мин. - макс.)	20 V DC - 30 V DC
Максимално потребление на ток	2,6 mA
Максимална дължина на линиите	3 м
Клас на безопасност	II съгласно IEC 60950 / EN 60950
Защита за EMI / EMC	EN 50081-1 / FCC Част 15
Клас на защита	IP 30 съгласно IEC 60529
Работна температура	-5 °C ... 50 °C (23 °F ... 122 °F)
Температура на съхранение	-20 °C ... 60 °C (-4 °F ... 140 °F)
Допустима относителна влажност	макс. 95% без кондензация
Материал и цвят на корпуса	ABS пластмаса Polylac PA-766 (UL94 V-0), полугланцов антрацит, RAL 7016
Размери (В x Ш x Д)	прибл. 127 x 96 x 60 мм
Тегло	прибл. 180 г

Popis funkcí

- Komunikační modul RS232 má dvě nezávislá rozhraní RS232 pro připojení tiskárny a přenosného počítače.

Kabeláž

Poz.	Označení	Připojení
15	RXD1	rozhraní 1 - RS232
16	TXD1	
17	GND	
20	RXD2	rozhraní 2 - RS232
21	TXD2	
22	GND	

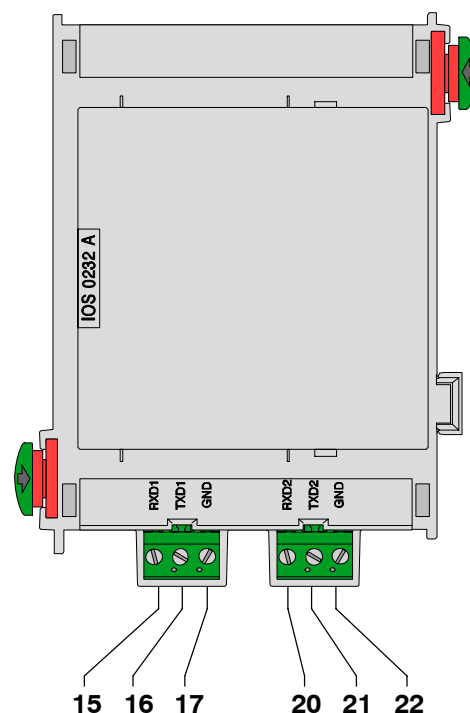

Obsazení kolíků DSUB - 9 kolíková zástrčka

Č. kolíku	Připojení
2	TxD0
3	RxD0
5	GND

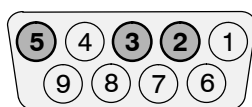

Technické údaje

Vstupní napětí (min. - max.)	20 V stejnosm. - 30 V stejnosm.
Maximální spotřeba proudu	2,6 mA
Maximální délka řádků	3 m u každého rozhraní
Třída bezpečnosti	II podle IEC 60950 / EN 60950
Ochrana EMI / EMC	EN 50081-1 / FCC Část 15
Krytí	IP 30 podle IEC 60529
Provozní teplota	-5 °C . . . 50 °C
Skladovací teplota	-20 °C . . . 60 °C
Přípustná relativní vlhkost	maximálně 95% nekondenzující
Materiál a barva krytu	plast ABS Polylac PA-766 (UL94 V-0), pololesklá antracitová, RAL 7016
Rozměry (v x š x h)	přibl. 127 mm x 96 mm x 60 mm
Hmotnost	přibl. 180 g

Funktionsbeschreibung

Das RS232 Schnittstellenmodul verfügt über zwei RS232 Schnittstellen zum Anschalten eines Druckers und/oder eines Laptops.

Klemmenbelegung

Pos.	Beschr.	Anschluß
15	RXD1	RS 232 Schnittstelle 1
16	TXD1	
17	GND	
20	RXD2	RS 232 Schnittstelle 2
21	TXD2	
22	GND	

Belegung des DSUB 9-Steckers

PIN-Nr.	Anschluß
2	TxD0
3	RxD0
5	GND

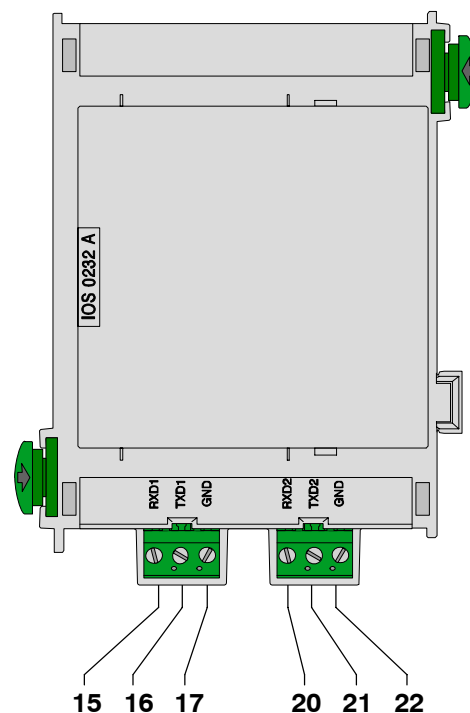
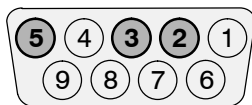

Technische Daten

Eingangsspannung (min - max)	20 V DC - 30 V DC / 5 V DC \pm 5%
Maximale Stromaufnahme	2,6 mA
Maximale Leitungslänge	3 m (3.28 yards) pro Schnittstelle
Sicherheitsklasse	II nach IEC 60950 / EN 60950
EMV-Störfestigkeit	EN 50130-4 / FCC Part 15
EMV-Störaussendung	EN 50081-1 / FCC Part 15
Schutzklasse	IP 30 nach IEC 60529
Zulässige Betriebstemperatur	-5 °C ... 50 °C (23 °F ... 122 °F)
Zulässige Lagertemperatur	-20 °C ... 60 °C (-4 °F ... 140 °F)
Zulässige relative Feuchte	max. 95% nicht kondensierend
Gehäusematerial und Farbe	ABS Kunststoff, Polyloc PA-766 (UL94 V-0), seidenmatt anthrazit, RAL 7016
Abmessungen (H x B x T)	ca. 127 x 96 x 60 mm (5.0 x 3.8 x 2.4 inches)
Gewicht	ca. 180 g (5.3 ounces)



Funktionsbeskrivelse

- RS232 kommunikationsmoduliet har to uafhængige RS232-stik, så der kan tilsluttes en printer og/eller en bærbar computer.

Kabelføring

Pos.	Afmærkning	Tilslutning
15	RXD1	RS232 stik 1
16	TXD1	
17	GND	
20	RXD2	RS232 stik 2
21	TXD2	
22	GND	

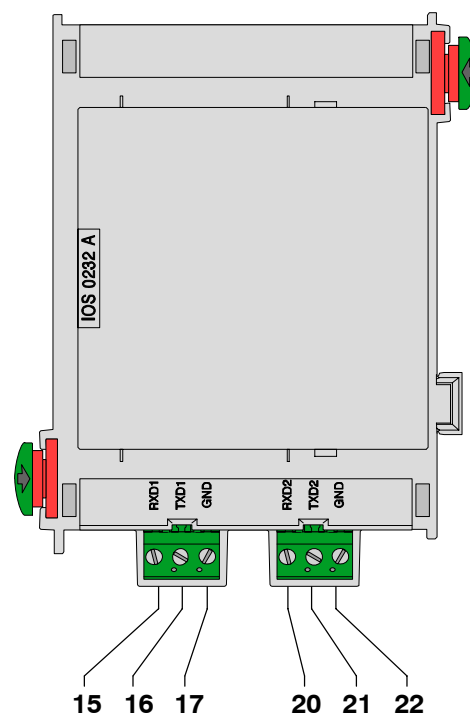

Ben-tildeling ved et DSUB 9-bens stik

BEN-Nr.	Tilslutning
2	TxD0
3	RxD0
5	GND

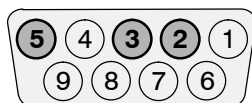

Tekniske specifikationer

Indgangsspænding (min. - maks.)	20 V DC - 30 V DC
Maks. strømforbrug	2,6 mA
Maks. linjelængde	3 m (3,28 yards) ved hvert stik
Sikkerhedsklasse	II i henhold til IEC 60950 / EN 60950
EMI / EMC beskyttelse	EN 50081-1 / FCC del 15
Beskyttelsesklasse	IP 30 i henhold til IEC 60529
Driftstemperatur	-5 °C . . . 50 °C
Opbevaringstemperatur	-20 °C . . . 60 °C
Tilladt relativ luftfugtighed	maks. 95% ikke kondenserende
Kabinetmateriale og -farve	ABS plast Polylac PA-766 (UL94 V-0), halvgloss antracit, RAL 7016
Dimensioner (H x B x D)	ca. 127 x 96 x 60mm
Vægt	ca. 180 g

Descripción de las funciones

- El módulo de comunicación RS232 proporciona dos interfaces RS232 independientes para conectar una impresora y/o un portátil.

Cableado

Pos.	Marcación	Conexión
15	RXD1	RS232 Interfaz 1
16	TXD1	
17	GND	
20	RXD2	RS232 Interfaz 2
21	TXD2	
22	GND	

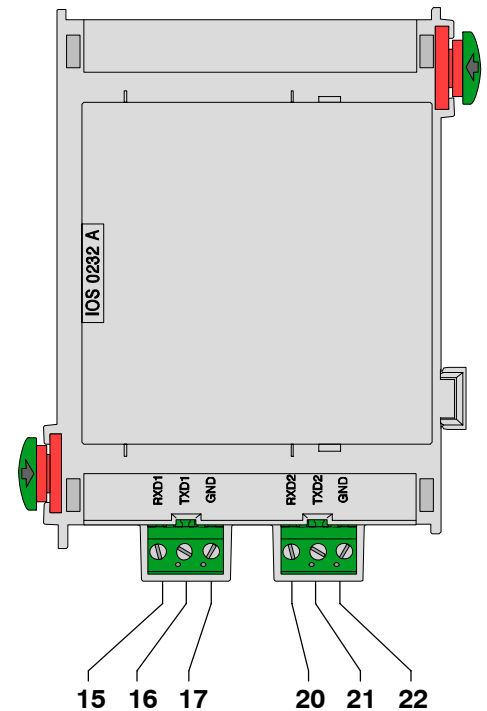

Asignación de clavijas del enchufe DSUB de 9 clavijas

CLAVIJA-Nº	Conexión
2	TxD0
3	RxD0
5	GND

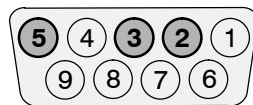

Especificaciones técnicas

Tensión de entrada (mín. - máx.)	20 V DC - 30 V DC
Consumo máximo de corriente	2,6 mA
Longitud de línea máxima	3 m (3,28 yardas) en cada interfaz
Clase de seguridad	II según IEC 60950 / EN 60950
Protección EMI / EMC	EN 50081-1 / FCC Parte 15
Clase de protección	IP 30 según IEC 60529
Temperatura de funcionamiento	-5 °C . . . 50 °C (23 °F . . . 122 °F)
Temperatura de almacenamiento	-20 °C . . . 60 °C (-4 °F . . . 140 °F)
Humedad relativa permitida	máx. 95% sin condensación
Material y color de la carcasa	Plástico ABS Polylac PA-766 (UL94 V-0), antracita semibrillante, RAL 7016
Dimensiones (A x A x P)	aprox. 127 x 96 x 60 mm (5,0 x 3,8 x 2,4 pulgadas)
Peso	aprox. 180 g (6,3 onzas)

Funktsionaalne kirjeldus

- RS232 moodul võimaldab ühendada kaks sõltumatut RS232 liidest arvuti või printeri ühendamiseks.

Juhtmete ühendamine

Jrk. nr.	Markeering	Liides
15	RXD1	RS232 Liides 1
16	TXD1	
17	GND	
20	RXD2	RS232 Liides 2
21	TXD2	
22	GND	

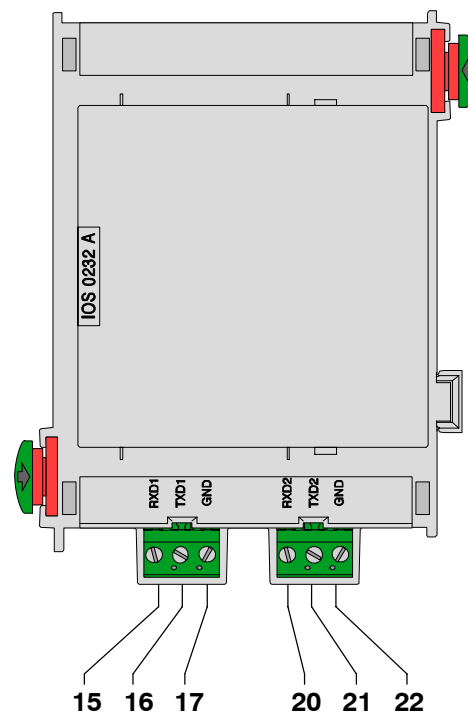

Kontaktide järjekord DSUB 9 pistikul

Kontakti nr.	Liides
2	TxD0
3	RxD0
5	GND

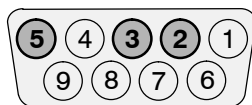

Tehniline kirjeldus

Sisendpinge (min. - maks.)	20 V DC - 30 V DC
Maksimaalne hetke voolutarbimine	2,6 mA
Maksimaalne juhtmepikkus	3 m (3,28 tolli) igal liidesel
Ohutusklass	II vastavalt IEC 60950 / EN 60950
EMI / EMC kaitse	EN 50081-1 / FCC Osa 15
Kaitseklass	IP 30 vastavalt IEC 60529
Käitamistemperatuur	-5 °C ... 50 °C (23 °F ... 122 °F)
Ladustamistemperatuur	-20 °C ... 60 °C (-4 °F ... 140 °F)
Lubatud suhteline niiskus	Maks. 95% mitte-kondenseeruv
Kaitseümbrise materjal ning värvus	ABS plastik Polyloc PA-766 (UL94 V-0), poolläikiv antratsiid, RAL 7016
Mõõtmed (Kõrgus x Laius x Sügavus)	Umbes 127 x 96 x 60 mm (5,0 x 3,8 x 2,4 tolli)
Kaal	Umbes 180 g (6,2 untsi)

Description fonctionnelle

- Le module de communication RS232 fournit deux interfaces RS232 indépendantes permettant de connecter une imprimante et/ou un ordinateur portable.

Câblage

N°	Marquage	Connexion
15	RXD1	Interface RS232 1
16	TXD1	
17	GND	
20	RXD2	Interface RS232 2
21	TXD2	
22	GND	

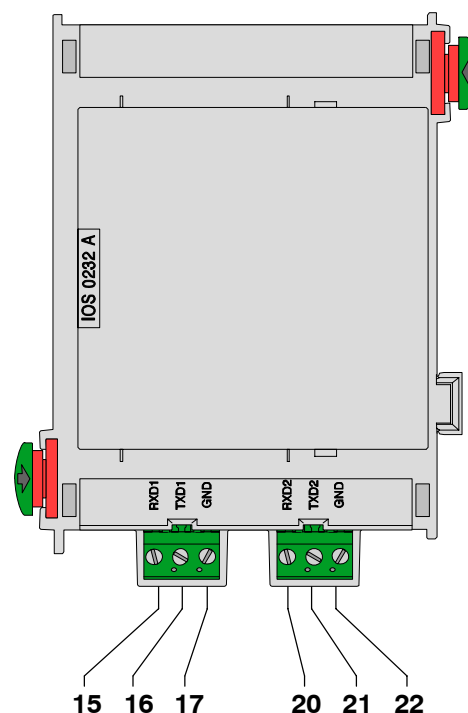

Affectation des broches de la fiche à 9 broches DSUB

N° broche	Connexion
2	TxD0
3	RxD0
5	GND

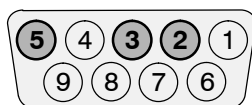

Caractéristiques techniques

Tension d'entrée (min. - max.)	20 - 30 V c.c.
Consommation de courant maximale	2,6 mA
Longueur maximale des lignes	3 m (3,28 yards) à chaque interface
Classe de sécurité	II conformément à CEI 60950 / EN 60950
Protection EMI / CEM	EN 50081-1 / FCC partie 15
Classe de protection	IP 30 conformément à CEI 60529
Température de fonctionnement	-5 °C ... 50 °C (23 °F ... 122 °F)
Température de stockage	-20 °C ... 60 °C (-4 °F ... 140 °F)
Taux d'humidité relative admissible	max. 95 % sans condensation
Matière et couleur du boîtier	Plastique ABS Polyac PA-766 (UL94 V-0), anthracite semi-brillant, RAL 7016
Dimensions (H x l x P)	env. 127 x 96 x 60 mm (5,0 x 3,8 x 2,4 pouces)
Poids	env. 180 g (6,3 onces)

Toiminnan kuvaus

- RS232-tiedonsiirtomoduulissa on kaksi itsenäistä RS232-liitäntää tulostimen ja/tai kannettavan tietokoneen liittämistä varten.

Johdotus

Tunnus	Merkintä	Liitäntä
15	RXD1	RS232-liitäntä 1
16	TXD1	
17	GND	
20	RXD2	RS232-liitäntä 2
21	TXD2	
22	GND	

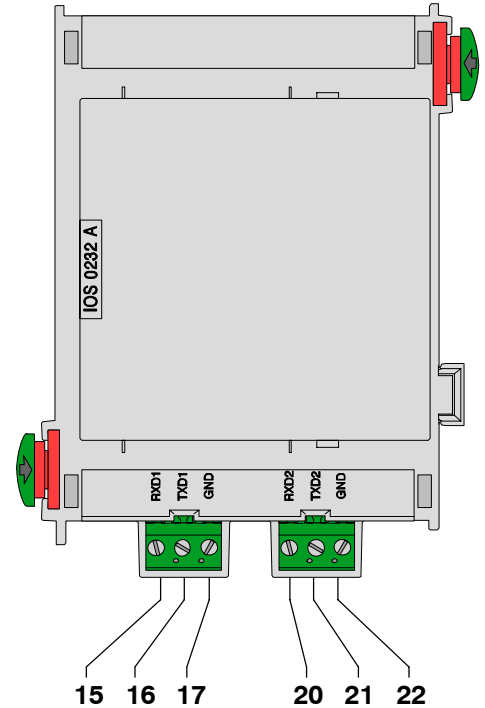

DSUB 9-nastaisen pistokkeen nastajärjestys

Nastanro	Liitäntä
2	TxD0
3	RxD0
5	GND

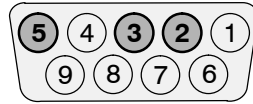

Tekniset tiedot

Tulojännite (min. - maks.)	20 V DC - 30 V DC
Virrankulutus enintään	2,6 mA
Linjojen enimmäispituus	3 m jokaisessa liitännässä
Turvallisuusluokitus	II, IEC 60950 / EN 60950 mukaisesti
EMI / EMC-suojaus	EN 50081-1 / FCC Part 15
Suojausluokitus	IP 30, IEC 60529 mukaisesti
Käyttölämpötila	-5 °C... 50 °C (23 °F... 122 °F)
Säilytyslämpötila	-20 °C... 60 °C (-4 °F... 140 °F)
Suhteellinen kosteus	enintään 95 % (tiivistymätön)
Kotelon materiaali ja väri	ABS-muovi, Polylac PA-766 (UL94 V-0) puolikiiltävä anthrazit, RAL 7016
Mitat (K x L x S)	noin 127 x 96 x 60 mm
Paino	noin 180 g

Functional description

- The RS232 communication module provides two independent RS232 interfaces to connect a printer and/or a Laptop.

Wiring

Pos.	Marking	Connection
15	RXD1	RS232 Interface 1
16	TXD1	
17	GND	
20	RXD2	RS232 Interface 2
21	TXD2	
22	GND	

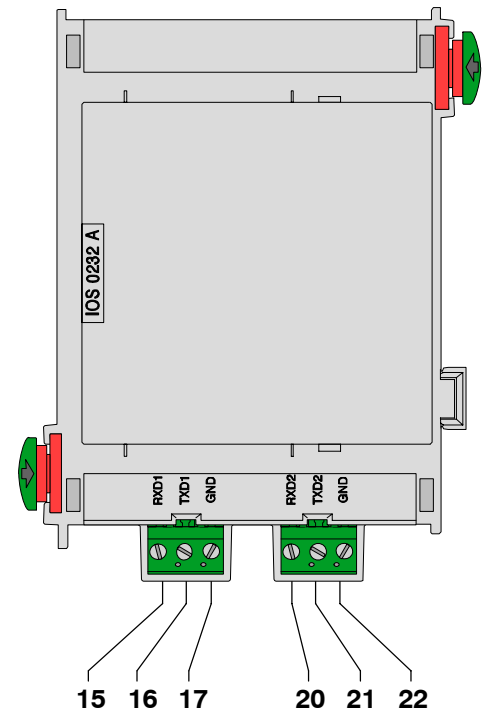

Pin-assignment of DSUB 9-pin plug

PIN-No.	Connection
2	TxD0
3	RxD0
5	GND

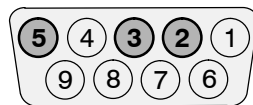

Technical Specification

Input voltage (min - max)	20 V DC - 30 V DC
Maximum current consumption	2.6 mA
Maximum length of lines	3 m (3.28 yards) at each interface
Safety class	II as per IEC 60950 / EN 60950
EMI / EMC protection	EN 50081-1 / FCC Part 15
Protection class	IP 30 as per IEC 60529
Operating Temperature	-5 °C . . . 50 °C (23 °F . . . 122 °F)
Storage Temperature	-20 °C . . . 60 °C (-4 °F . . . 140 °F)
Permissible relative humidity	max. 95% non condensing
Housing material and color	ABS plastic Polylac PA-766 (UL94 V-0), semi gloss anthracite, RAL 7016
Dimensions (H x W x D)	approx. 127 x 96 x 60mm (5.0 x 3.8 x 2.4 inches)
Weight	approx. 180 g (6.3 ounces)

Περιγραφή λειτουργίας

- Το δομοστοιχείο επικοινωνίας RS232 παρέχει δύο ανεξάρτητες διασυνδέσεις RS232 για τη σύνδεση ενός εκτυπωτή ή/και φορητού υπολογιστή.

Καλωδίωση

Θέση.	Σήμανση	Σύνδεση
15	RXD1	Διασύνδεση RS232 αρ. 1
16	TXD1	
17	GND	
20	RXD2	Διασύνδεση RS232 αρ. 2
21	TXD2	
22	GND	

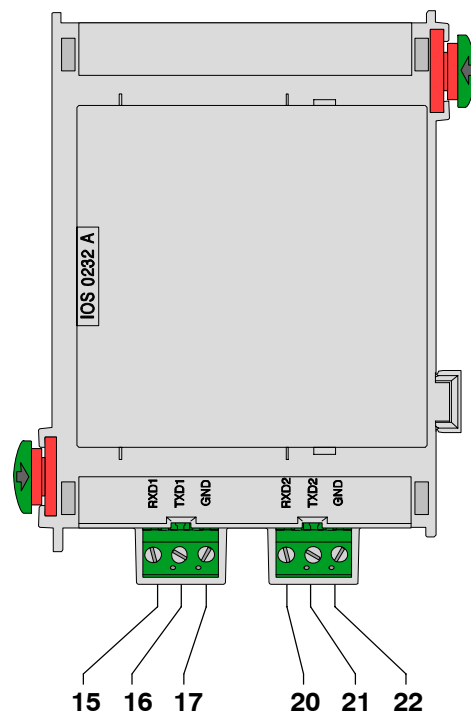

Αντιστοιχία ακίδων του βύσματος DSUB 9 ακίδων

Αρ. ΑΚΙΔΑΣ	Σύνδεση
2	TxD0
3	RxD0
5	GND

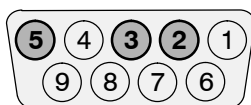

Τεχνικές προδιαγραφές

Τάση εισόδου (ελάχ. - μέγ.)	20 V DC - 30 V DC
Μέγιστη κατανάλωση ρεύματος	2,6 mA
Μέγιστο μήκος γραμμών	3 m (3,28 γυάρδες) για κάθε διασύνδεση
Κατηγορία ασφαλείας	II κατά IEC 60950 / EN 60950
Προστασία EMI / EMC	EN 50081-1 / FCC Μέρος 15
Κατηγορία προστασίας	IP 30 κατά IEC 60529
Θερμοκρασία λειτουργίας	-5 °C ... 50 °C (23 °F ... 122 °F)
Θερμοκρασία αποθήκευσης	-20 °C ... 60 °C (-4 °F ... 140 °F)
Επιτρεπτή σχετική υγρασία	Μέγ. 95% μη συμπυκνούμενη
Υλικό κατασκευής και χρώμα περιβλήματος	Πλαστικό ABS Polylac PA-766 (UL94 V-0), ημι-γυαλιστερό ανθρακί, RAL 7016
Διαστάσεις (Υ x Π x Β)	περ. 127 x 96 x 60 mm (5,0 x 3,8 x 2,4")
Βάρος	περ. 180 g (6,3 ounces)

A működés ismertetése

- Az RS232 kommunikációs modul két független RS232 interfészt biztosít nyomtató és/vagy egy laptop csatlakoztatására.

Vezetékezés

Poz.	Jelzés	Csatlakozás
15	RXD1	RS232 1. interfész
16	TXD1	
17	GND	
20	RXD2	RS232 2. interfész
21	TXD2	
22	GND	

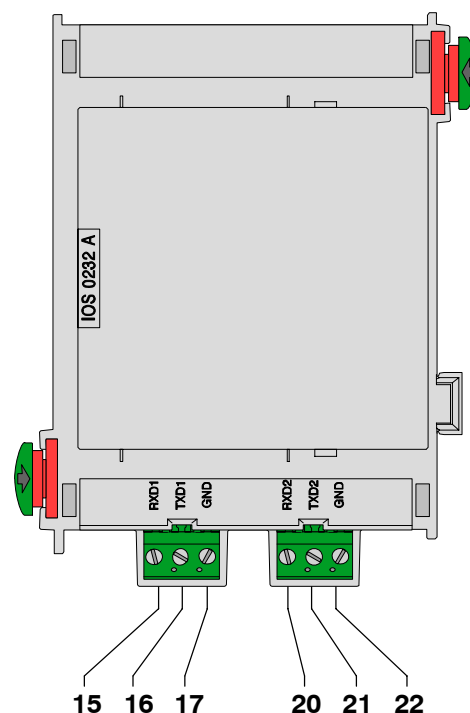

DSUB 9-pólusú csatlakozó dugó lábkiosztása

Érintkező száma	Csatlakozás
2	TxD0
3	RxD0
5	GND

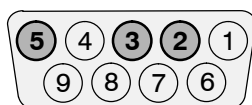

Műszaki adatok

Bemenő feszültség (min. - max.)	20 V egyenáram - 30 V egyenáram
Maximális áramfelvétel	2,6 mA
Vonalak maximális hossza	3 m mindegyik interfésznél
Biztonsági osztály	II az IEC 60950 / EN 60950 szerint
EMI / EMC-védelem	EN 50081-1 / FCC 15. rész
Védettség	IP 30 az IEC 60529 szerint
Üzemi hőmérséklet	-5 °C . . . 50 °C
Tárolási hőmérséklet	-20 °C . . . 60 °C
Megengedett relatív páratartalom	max. 95% nem lecsapódó
Ház anyaga és színe	ABS műanyag Polylac PA-766 (UL94 V-0), félfényes antracit, RAL 7016
Méretetek (mag. x szél. x mélys.)	kb. 127 x 96 x 60 mm
Súly	kb. 180 g

Opis funkcija

- Komunikacijski modul RS232 sadrži dva nezavisna RS232 sučelja za spajanje pisača i/ili prijenosnog računala.

Ožičenje

Pol.	Oznaka	Priključak
15	RXD1	RS232 sučelje 1
16	TXD1	
17	GND	
20	RXD2	RS232 sučelje 2
21	TXD2	
22	GND	

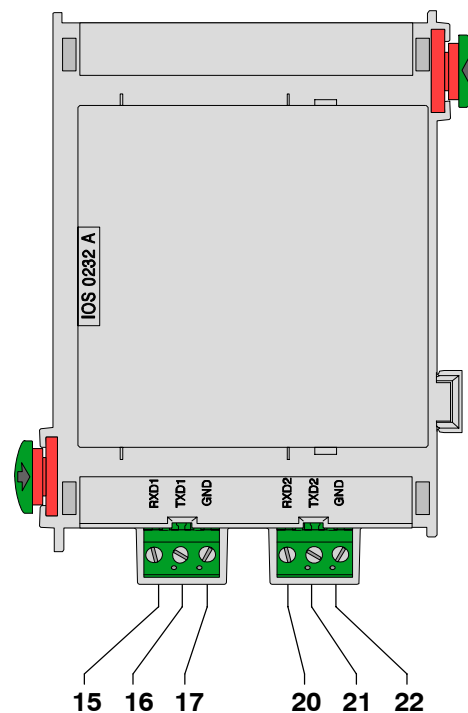

Dodjela pina za DSUB 9 priključak za pin

Broj PIN-a	Priključak
2	TxD0
3	RxD0
5	GND

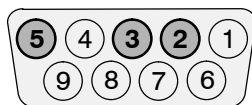

Tehničke specifikacije

Ulazni napon (min - maks)	20 V DC - 30 V DC
Maksimalna potrošnja struje	2,6 mA
Maksimalna duljina voda	3 m (3,28 jarda) po svakom sučelju
Sigurnosna klasa	II po IEC 60950 / EN 60950
EMI / EMC zaštita	EN 50081-1 / FCC dio 15
Zaštitna klasa	IP 30 po IEC 60529
Radna temperatura	-5 °C ... 50 °C (23 °F ... 122 °F)
Temperatura za skladištenje	-20 °C ... 60 °C (-4 °F ... 140 °F)
Dopuštena relativna vlažnost	maks. 95% bez kondenzacije
Materijal i boja kućišta	ABS plastika Polylac PA-766 (UL94 V-0), polusjajni antracit, RAL 7016
Dimenzije (V x Š x D)	oko 127 x 96 x 60mm (5,0 x 3,8 x 2,4 inča)
Težina	oko 180 g (6,3 unci)

Descrizione funzionale

- Il modulo di comunicazione RS232 dispone di due interfacce RS232 indipendenti per il collegamento di una stampante e/o di un laptop.

Cablaggio

Pos.	Contrassegno	Collegamento
15	RXD1	Interfaccia RS232 1
16	TXD1	
17	GND	
20	RXD2	Interfaccia RS232 2
21	TXD2	
22	GND	

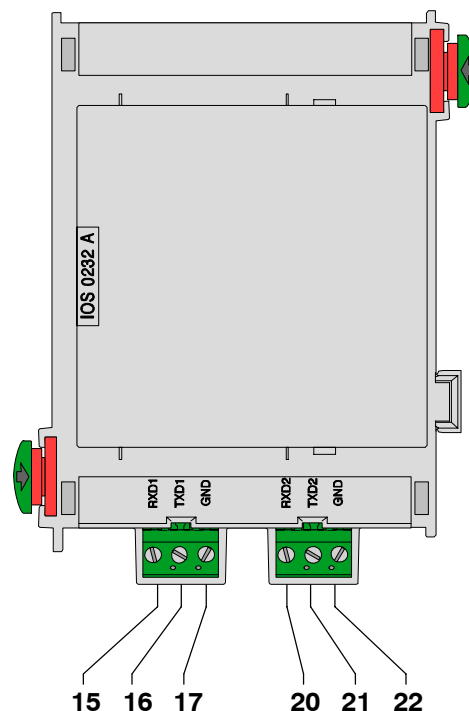

Assegnazione pin di un connettore SUB-D a 9 pin

N. PIN	Collegamento
2	TxD0
3	RxD0
5	GND

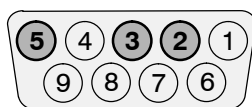

Specifiche tecniche

Tensione di ingresso (min - max)	20 V CC - 30 V CC
Consumo di corrente max.	2,6 mA
Lunghezza linee max.	3 m su ciascuna interfaccia
Classe di sicurezza	II come previsto dalle norme IEC 60950 / EN 60950
Protezione EMI / EMC	EN 50081-1 / FCC Parte 15
Grado di protezione	IP 30 come previsto dalla norma IEC 60529
Temperatura operativa	-5 °C ... 50 °C (23 °F ... 122 °F)
Temperatura di stoccaggio	-20 °C ... 60 °C (-4 °F ... 140 °F)
Umidità relativa consentita	max. 95% senza condensa
Materiale e colore custodia	plastica ABS Polyloc PA-766 (UL94 V-0), antracite semilucida, RAL 7016
Dimensioni (A x L x P)	circa 127 x 96 x 60 mm
Peso	circa 180 g

Funkcijų aprašymas

- RS232 komunikacinis modulis su dviem nepriklausomomis RS232 sąsajomis, per kurias galima prijungti spausdintuvą ir / arba nešiojamąjį kompiuterį.

Laidai

Poz.	Žyma	Jungtis
15	RXD1	RS232 1 sąsaja
16	TXD1	
17	GND	
20	RXD2	RS232 2 sąsaja
21	TXD2	
22	GND	

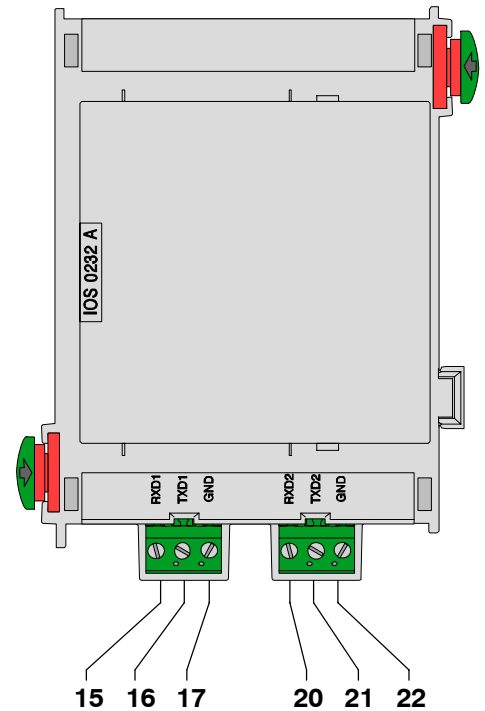

Pin priskyrimas įjungus DSUB 9 pin

PIN Nr.	Jungtis
2	TxD0
3	RxD0
5	GND

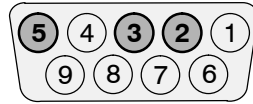

Techninės specifikacijos

Įėjimo įtampa (min. - maks.)	20 V - 30 V (pastovi srovė)
Didžiausias srovės sunaudojimas	2,6 mA
Maksimalus linijų ilgis	3 m (kiekvienos sąsajos)
Saugos klasė	II pagal IEC 60950 / EN 60950
EMI / EMC sauga	EN 50081-1 / FCC 15 dalis
Saugos klasė	IP 30 pagal IEC 60529
Veikimo temperatūra	-5 °C ... 50 °C (23 °F ... 122 °F)
Laikymo temperatūra	-20 °C ... 60 °C (-4 °F ... 140 °F)
Leistina santykinė drėgmė	maks. 95% nesikondensuoja
Korpuso medžiaga ir spalva	ABS plastikas "Polylac PA-766" (UL94 V-0), pusiau blizgus antracitas, RAL 7016
Dydžiai (aukštis x plotis x gylis)	apie 127 x 96 x 60mm
Svoris	apie 180 g

Funkcionālais apraksts

- RS232 komunikāciju modulis nodrošina divus neatkarīgus RS232 interfeisus, lai pievienotu printeri un/vai piezīmjdatoru.

Vadojums

Pozīcija	Marķējums	Savienojums
15	RXD1	RS232 1. interfeiss
16	TXD1	
17	GND	
20	RXD2	RS232 2. interfeiss
21	TXD2	
22	GND	

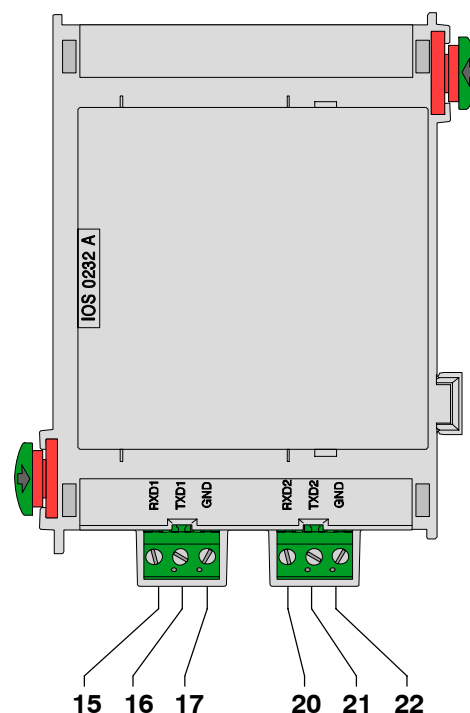

DSUB 9 spraudņu kontakta spraudņu nozīme

Spraudnis Nr.	Savienojums
2	TxD0
3	RxD0
5	GND

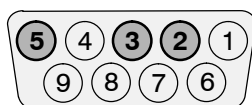

Tehniskā specifikācija

Ieejas spriegums (minimālais - maksimālais)	20 V DC - 30 V DC
Maksimālais strāvas patēriņš	2,6 mA
Maksimālais līniju garums	3 m (3,28 jardi) katram interfeisam
Drošības klase	II, saskaņā ar IEC 60950 / EN 60950
EMI / EMC aizsardzība	EN 50081-1 / FCC Part 15
Aizsardzības klase	IP 30, saskaņā ar IEC 60529
Darba temperatūra	-5 °C ... 50 °C (23 °F ... 122 °F)
Uzglabāšanas temperatūra	-20 °C ... 60 °C (23 °F ... 140 °F)
Pieļaujamais relatīvais mitrums	maks. 95%, nekondensējošs
Apvalka materiāls un krāsa	ABS plastmasa Polylac PA-766 (UL94 V-0), daļēji glancēts antracīts, RAL 7016
Izmēri (A x P x D)	aptuveni 127 x 96 x 60 mm (5,0 x 3,8 x 2,4 collas)
Svars	aptuveni 180 g (6,3 unces)

Funksjonsbeskrivelse

- RS232-kommunikasjonsmodulen har to uavhengige RS232-grensesnitt der det kan kobles til en skriver og/eller en bærbar datamaskin.

Kabling

Pos.	Markering	Tilkobling
15	RXD1	RS232-grensesnitt 1
16	TXD1	
17	GND	
20	RXD2	RS232-grensesnitt 2
21	TXD2	
22	GND	

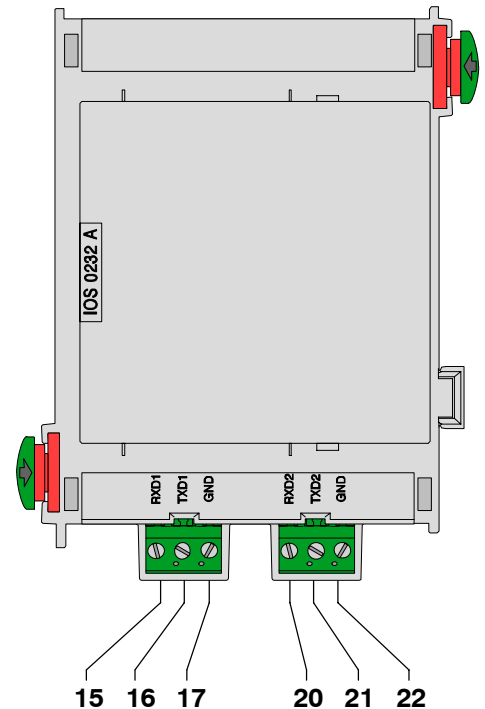

Pinnetildeling på DSUB 9-pinners plugg

Pinnennummer	Tilkobling
2	TxD0
3	RxD0
5	GND

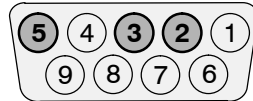

Tekniske spesifikasjoner

Inngangsspenning (min. - maks.)	20 - 30 V DC
Maksimalt strømforbruk	2,6 mA
Maksimal ledningslengde	3 m (3,28 yard) ved hvert grensesnitt
Sikkerhetsklasse	II i henhold til IEC 60950 / EN 60950
EMI- / EMC-beskyttelse	EN 50081-1 / FCC del 15
Beskyttelsesklasse	IP 30 i henhold til IEC 60529
Driftstemperatur:	-5 °C ... 50 °C (23 °F ... 122 °F)
Lagringstemperatur	-20 °C ... 60 °C (-4 °F ... 140 °F)
Tillatt relativ fuktighet	Maks. 95 % ikke-kondenserende
Husmateriale og -farge	ABS-plast Polylac PA-766 (UL94 V-0), halvblank koksgrå, RAL 7016
Mål (H x B x D)	Ca. 127 x 96 x 60 mm (5,0 x 3,8 x 2,4 tommer)
Vekt	Ca. 180 g (6,3 unser)

Functies

- De RS232-commicatiemodule biedt twee onafhankelijke RS232-interfaces voor de aansluiting van een printer of laptop.

Bekabeling

Pos.	Markering	Aansluiting
15	RXD1	RS232-interface 1
16	TXD1	
17	GND	
20	RXD2	RS232-interface 2
21	TXD2	
22	GND	

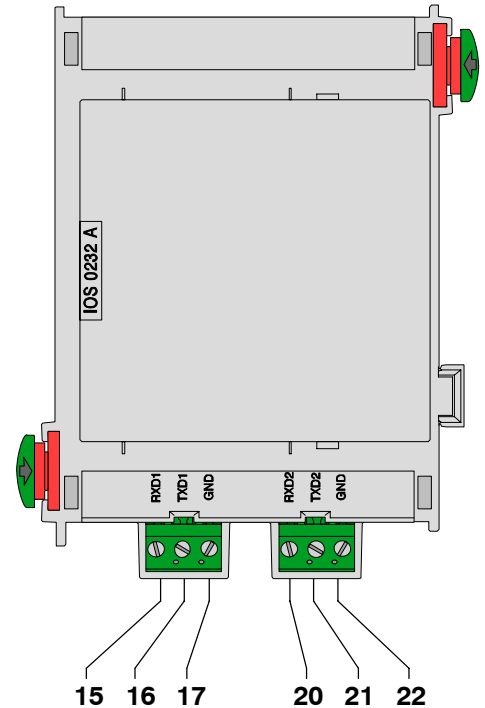

Penbezetting van 9-polige DSUB-stekker

Pennr.	Aansluiting
2	TxD0
3	RxD0
5	GND

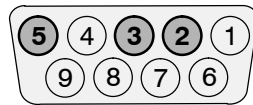

Technische specificatie

Ingangsspanning (min - max)	20 V DC - 30 V DC
Maximaal stroomverbruik	2,6 mA
Maximale kabellengte	3 m op elke interface
Veiligheidsklasse	II volgens IEC 60950 / EN 60950
EMI/EMC-beveiliging	EN 50081-1 / FCC deel 15
Beschermingsklasse	IP 30 volgens IEC 60529
Bedrijfstemperatuur	-5 °C . . . 50 °C
Opslagtemperatuur	-20 °C . . . 60 °C
Toegestane relatieve vochtigheid	max. 95% niet-condenserend
Materiaal en kleur van de behuizing	ABS-kunststof Polylac PA-766 (UL94 V-0), halfglans antraciet, RAL 7016
Afmetingen (H x B x D)	ca. 127 x 96 x 60 mm
Gewicht	ca. 180 g

Descrição funcional

- O módulo de comunicação RS232 fornece duas interfaces RS232 independentes para estabelecer ligação a uma impressora e/ou a um computador portátil.

Ligações eléctricas

Pos.	Marcação	Ligação
15	RXD1	Interface RS232 1
16	TXD1	
17	GND	
20	RXD2	Interface RS232 2
21	TXD2	
22	GND	

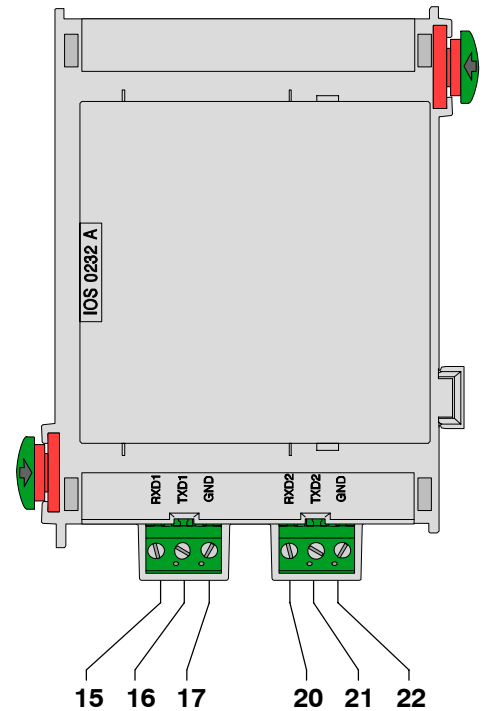

Atribuição de pinos da ficha DSUB 9

N.º do pino	Ligação
2	TxD0
3	RxD0
5	GND

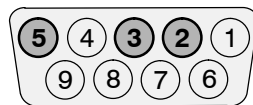

Especificações técnicas

Tensão de entrada (mín - máx)	20 V CC - 30 V CC
Consumo máximo de corrente	2,6 mA
Comprimento máximo das linhas	3 m em cada interface
Classe de segurança	II em conformidade com a norma IEC 60950 / EN 60950
Protecção EMI / EMC	EN 50081-1 / FCC Parte 15
Classe de protecção	IP 30 em conformidade com a norma IEC 60529
Temperatura de funcionamento	-5 °C . . . 50 °C (23 °F . . . 122 °F)
Temperatura de armazenamento	-20 °C . . . 60 °C (-4 °F . . . 140 °F)
Humidade relativa permitida	máx. 95% sem condensação
Material e cor da caixa	Plástico ABS Polylac PA-766 (UL94 V-0), antracite semibrilhante, RAL 7016
Dimensões (A x L x P)	aprox. 127 x 96 x 60 mm (5,0 x 3,8 x 2,4 polegadas)
Peso	aprox. 180 g (6,3 onças)

Opis działania

- Moduł komunikacyjny RS232 posiada dwa niezależne interfejsy RS232 umożliwiające podłączenie drukarki i / lub komputera przenośnego.

Gniazda połączeniowe

Pozycja	Oznaczenie	Połączenie
15	RXD1	Interfejs RS232 1
16	TXD1	
17	GND	
20	RXD2	Interfejs RS232 2
21	TXD2	
22	GND	

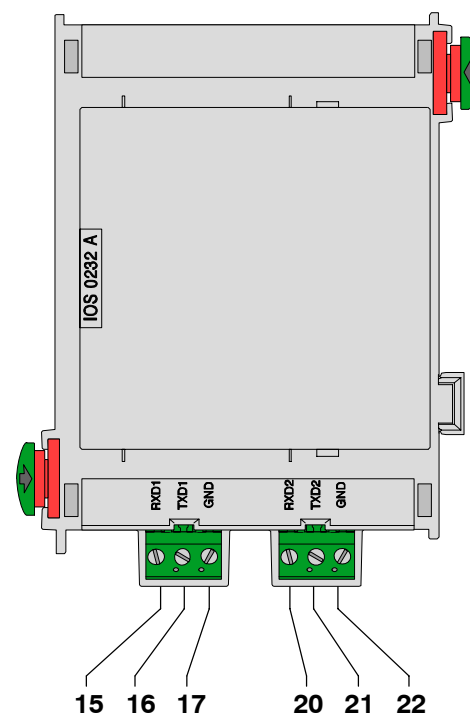

Przyporządkowanie styków złącza 9-stykowego Sub-D

Nr styku	Połączenie
2	TxD0
3	RxD0
5	GND

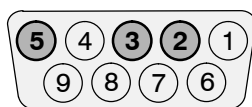

Dane techniczne

Napięcie wejściowe (min. - maks.)	20 VDC - 30 VDC
Maksymalny pobór prądu	2,6 mA
Maksymalna długość linii	3 m (każdy interfejs)
Klasa bezpieczeństwa	II zgodnie z IEC 60950 / EN 60950
Ochrona przed zakłóceniami EMI / EMC	EN 50081-1 / FCC, Część 15
Klasa ochrony	IP 30 zgodnie z IEC 60529
Temperatura pracy	-5 °C . . . 50 °C
Temperatura przechowywania	-20 °C . . . 60 °C
Dopuszczalna wilgotność względna	maks. 95% bez kondensacji
Materiał i kolor obudowy	tworzywo ABS Polylac PA-766 (UL94 V-0) antracyt, półpołysk, RAL 7016
Wymiary (wys. x szer. x gł.)	ok. 127 x 96 x 60 mm
Masa	ok. 180 g

Descriere funcțională

- Modulul de comunicare RS232 oferă două interfețe RS232 independente pentru conectarea unei imprimante și/sau a unui laptop.

Cablare

Nr.	Nume	Conexiune
15	RXD1	Interfață RS232 - 1
16	TXD1	
17	GND	
20	RXD2	Interfață RS232 - 2
21	TXD2	
22	GND	

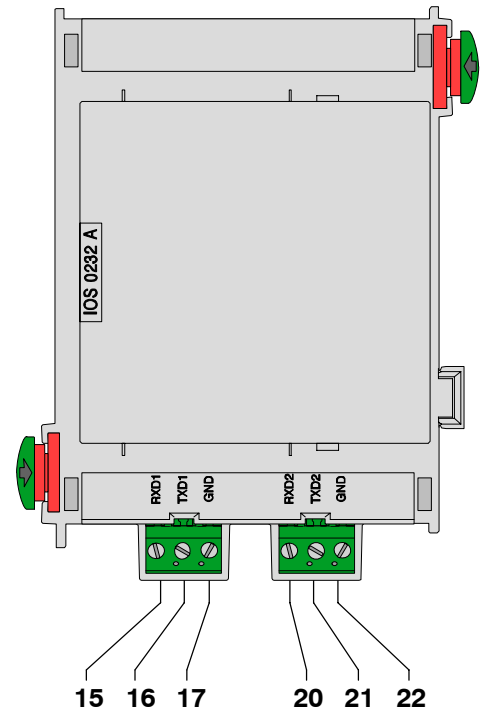

Repartizarea pinilor conectorului DSUB cu 9 pini

Nr. pin	Conexiune
2	TxD0
3	RxD0
5	GND

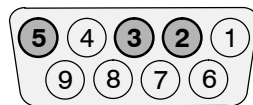

Specificații tehnice

Tensiune de intrare (min - max)	20 V CC - 30 V CC
Consum maxim de energie	2,6 mA
Lungime maximă a liniilor	3 m (3,28 yd.) la fiecare interfață
Clasă de siguranță	II cf. IEC 60950 / EN 60950
Protecție EMI / EMC	EN 50081-1 / FCC Part 15
Clasă de protecție	IP 30 cf. IEC 60529
Temperatură de funcționare	-5 °C ... 50 °C (23 °F ... 122 °F)
Temperatură de stocare	-20 °C ... 60 °C (-4 °F ... 140 °F)
Umiditate relativă permisă	max. 95% fără condensare
Material și culoare carcasă	Plastic ABS Polydac PA-766 (UL94 V-0), antracit semi-lucios, RAL 7016
Dimensiuni (H x l x A)	aprox. 127 x 96 x 60 mm (5,0 x 3,8 x 2,4 inch)
Greutate	aprox. 180 g (6,3 oz.)

Описание принципа действия

- Коммуникационный модуль RS232 обеспечивает два независимых интерфейса RS232 для подключения принтера и/или портативного компьютера.

Подключения

Поз.	Маркировка	Соединение
15	RXD1	Интерфейс 1 RS232
16	TXD1	
17	GND	
20	RXD2	Интерфейс 2 RS232
21	TXD2	
22	GND	

Разводка выводов 9-контактного разъема DSUB

PIN-№.	Соединение
2	TxD0
3	RxD0
5	GND

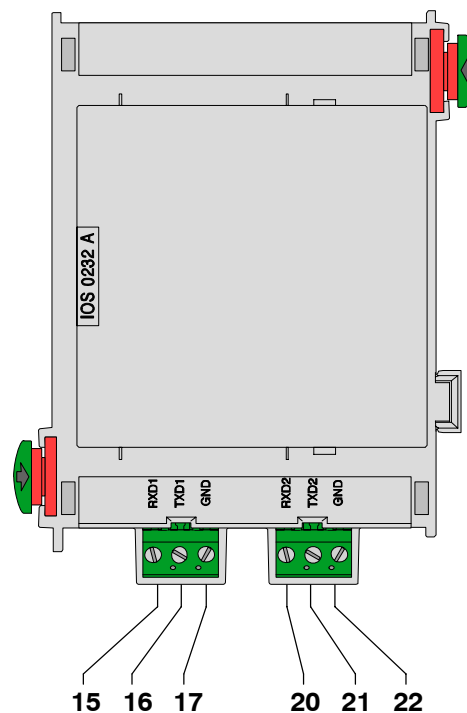
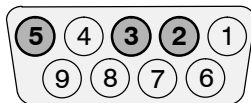

Техническое описание

Напряжение на входе (мин - макс)	20 В пост. тока - 30 В пост. тока
Максимальное потребление тока	2,6 мА
Максимальная длина линий	3 м (3,28 ярда) на каждый интерфейс
Класс безопасности	II по IEC 60950 / EN 60950
Защита от электромагнитных помех / электромагнитной совместимости	EN 50081-1 / FCC часть 15
Класс защиты	IP 30 по IEC 60529
Рабочая температура	-5 °C ... 50 °C (23 °F ... 122 °F)
Температура хранения	-20 °C ... 60 °C (-4 °F ... 140 °F)
Допустимая относительная влажность	макс. 95% без конденсата
Материал и цвет корпуса	Пластмасса ABS Polyloc PA-766 (UL94 V-0), полуматовый антрацит, RAL 7016
Размеры (В x Ш x Г)	приблиз. 127 x 96 x 60 мм (5,0 x 3,8 x 2,4 дюйма)
Вес	приблиз. 180 г (6,3 унции)



Funktionsbeskrivning

- RS232-kommunikationsmodulen har två självständiga RS232-gränssnitt som kan användas till att ansluta till en skrivare och/eller en bärbar dator.

Anslutningar

Pos.	Märkning	Anslutning
15	RXD1	RS232-gränssnitt 1
16	TXD1	
17	GND	
20	RXD2	RS232-gränssnitt 2
21	TXD2	
22	GND	

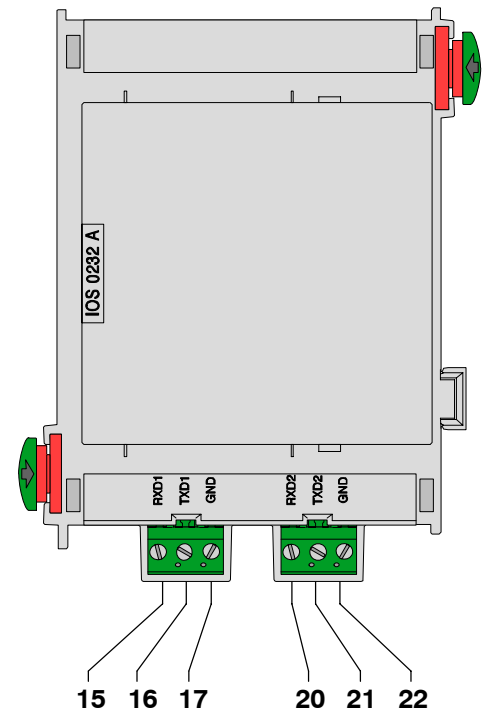

Stifttilldelning för DSUB 9-stiftskontakt

Stift nr.	Anslutning
2	TxD0
3	RxD0
5	GND

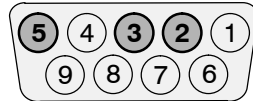

Tekniska specifikationer

Inspänning (min - max)	20 V till 30 V likström
Maximal strömförbrukning	2,6 mA
Maximal ledningslängd	3 m vid varje gränssnitt
Säkerhetsklass	II enligt IEC 60950 / EN 60950
EMI / EMC-skydd	EN 50081-1 / FCC del 15
Skyddsklass	IP 30 enligt IEC 60529
Driftstemperatur	-5 °C till 50 °C
Förvaringstemperatur	-20 °C till 60 °C
Tillåten relativ luftfuktighet	max. 95 % ickekondenserande
Inkapslingsmaterial och -färg	ABS-plast Polylac PA-766 (UL94 V-0), halvglättad antracit, RAL 7016
Mått (H x B x D)	ca 127 x 96 x 60 mm
Vikt	ca 180 g

Opis funkcija

- Komunikacijski modul RS232 sadrži dva nezavisna RS232 interfejsa za spajanje štampača i/ili prenosnog računara.

Ožičenje

Pol.	Oznaka	Priključak
15	RXD1	RS232 interfejs 1 1
16	TXD1	
17	GND	
20	RXD2	RS232 interfejs 2
21	TXD2	
22	GND	

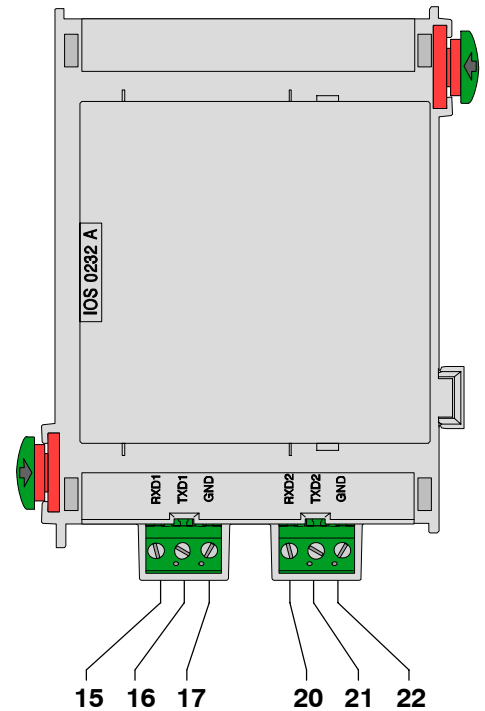

Dodela pina za DSUB 9 priključak za pin

Broj PIN-a	Priključak
2	TxD0
3	RxD0
5	GND

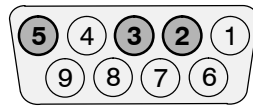

Tehničke specifikacije

Ulazni napon (min - maks)	20 V DC - 30 V DC
Maksimalna potrošnja struje	2,6 mA
Maksimalna dužina voda	3 m (3,28 jarda) po svakom interfejsu
Klasa bezbednosti	II po IEC 60950 / EN 60950
EMI / EMC zaštita	EN 50081-1 / FCC deo 15
Zaštitna klasa	IP 30 po IEC 60529
Radna temperatura	-5 °C ... 50 °C (23 °F ... 122 °F)
Temperatura za skladištenje	-20 °C ... 60 °C (-4 °F ... 140 °F)
Dozvoljena relativna vlažnost	maks. 95% bez kondenzacije
Materijal i boja kućišta	ABS plastika Polylac PA-766 (UL94 V-0), polusjajni antracit, RAL 7016
Dimenzije (V x Š x D)	oko 127 x 96 x 60 mm (5,0 x 3,8 x 2,4 inča)
Težina	oko 180 g (6,3 unci)

Funkcionalni opis

- Komunikacijski modul RS232 ima dva neodvisna vmesnika RS232 za priključitev tiskalnika in/ali prenosnega računalnika.

Električna povezava

Pol.	Oznaka	Povezava
15	RXD1	RS232 vmesnik 1
16	TXD1	
17	GND	
20	RXD2	RS232 vmesnik 2
21	TXD2	
22	GND	

Dodelitev pinov 9-pinskega vtiča DSUB

Št. PIN	Povezava
2	TxD0
3	RxD0
5	GND

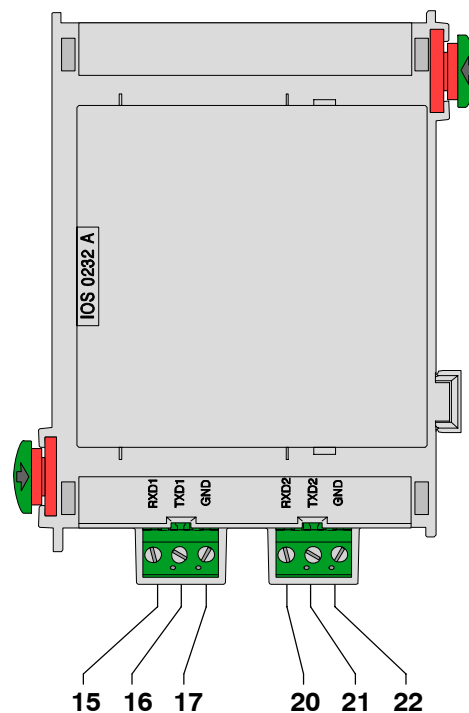
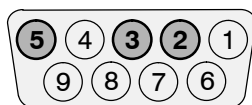

Tehnične specifikacije

Vhodna napetost (min. - maks.)	20 V DC - 30 V DC
Maksimalna poraba toka	2,6 mA
Maksimalna dolina vodov	3 m pri vsakem vmesniku
Varnostni razred	II po standardu IEC 60950 / EN 60950
Zaščita EMI / EMC	EN 50081-1 / FCC del 15
Razred zaščite	IP 30 po standardu IEC 60529
Delovna temperatura	-5 °C ... 50 °C (23 °F ... 122 °F)
Hrambna temperatura	-20 °C ... 60 °C (-4 °F ... 140 °F)
Dovoljena relativna vlaga	maks. 95 % brez kondenza
Material in barva ohišja	ABS plastika poliuretanski lak PA-766 (UL94 V-0), polsijajni antracitni, RAL 7016
Dimenzije (V x Š x G)	pribl. 127 x 96 x 60 mm
Masa	pribl. 180 g

Fonksiyonel açıklamalar

- RS232 iletişim modülü yazıcı ve/veya dizüstü bilgisayar bağlantısı için iki bağımsız RS232 arabirimi sağlamaktadır.

Kablo bağlantısı

Konum.	İşaret	Bağlantı
15	RXD1	RS232 Arabirimi 1
16	TXD1	
17	GND	
20	RXD2	RS232 Arabirimi 2
21	TXD2	
22	GND	

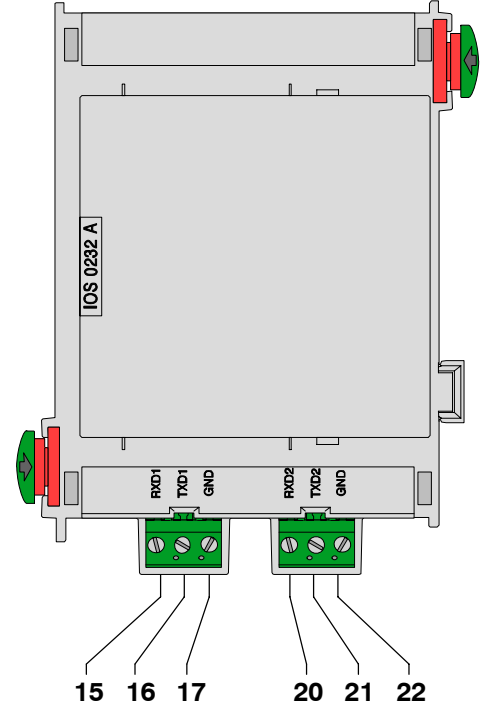

DSUB 9 pimli soketin pim ataması

PIN No.	Bağlantı
2	TxD0
3	RxD0
5	GND

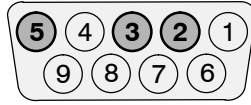

Teknik Özellikler

Giriş gerilimi (min - maks)	20 V DC - 30 V DC
Maksimum akım tüketimi	2,6 mA
Hatların maksimum uzunluğu	3 m (3,28 yard), her bir arabirimde
Güvenlik sınıfı	IEC 60950 / EN 60950 uyarınca II
EMI / EMC koruma	EN 50081-1 / FCC Bölüm 15
Koruma sınıfı	IEC 60529 uyarınca IP 30
Çalışma Sıcaklığı	-5 °C ... 50 °C (23 °F ... 122 °F)
Saklama Sıcaklığı	-20 °C ... 60 °C (-4 °F ... 140 °F)
İzin verilen bağıl nem	maks. %95 yoğunlaşmasız
Muhafaza malzemesi ve rengi	ABS plastik Polyloc PA-766 (UL94 V-0), yarı cam antrazit, RAL 7016
Boyutlar (Y x G x D)	yaklaşık 127 x 96 x 60 mm (5 x 3,8 x 2,4 inç)
Ağırlık	yaklaşık 180 g (6,3 ons)

BOSCH

**Bosch Sicherheitssysteme GmbH
Robert-Koch-Straße 100
D-85521 Ottobrunn**

**Info-Service
www.bosch-sicherheitssysteme.de
info.service@de.bosch.com**