



TECHNICAL MANUAL

Turbine IP Intercoms

TCIS / TCIV / TFIE / TFIX / TMIS / ECPIR-3P

About this Document

Document Scope

This document describes the setup procedure and configuration of the various models of the Turbine Compact and Extended IP Intercom series. The configuration procedures described here are for the general functions of the Turbine range. For information on more advanced features and settings, see [Zenitel Wiki](#).

Firmware Version: VSF-Turbine 5.1 (software package vsft-5.1.3.0 or later)

Model	Product Description	Item No.	Accessories
TFIE-1	Turbine Extended Industrial IP Intercom	1008122010	TA-23 Handset for Industrial Stations - 1008140230
TFIE-2	Turbine Extended Industrial IP Intercom	1008122020	EMMAI-2H Handheld Compact Mic for Industrial Stations - 1023533312
TFIE-6	Turbine Extended Industrial IP Intercom	1008122060	TA-22b Cable and Plugbox for AK5850HS Headset - 1008140225 TA-10 Connection Board with Relays for Turbine Industrial - 1008140100
TKIE-2	Turbine Extended Industrial Kit	1008132010	
TFIX-1	Turbine Extended Ex IP Intercom	1008123010	Headset for Ex & Industrial Stations - AK5850HS
TFIX-2	Turbine Extended Ex IP Intercom	1008123020	TAX-2b Cable and Plugbox for AK5850HS Headset - 1008150025
TFIX-3	Turbine Extended Ex IP Intercom	1008123030	TAX-3 Handset for Ex Stations - 1008150030
TFIX-4	Turbine Extended Ex IP Intercom	1008123040	EMMAX-1H Handheld Microphone for Ex Stations - 1023533511
ECPIR-3P	Turbine Extended Indoor Intercom	1023200033	PAM1H Handheld Microphone - 1023533012 EBMDR-8 8-Button Expansion Module - 1023253008
TMIS-1	Turbine Mini IP Intercom	1008116010	
TMIS-2	Turbine Mini IP Intercom	1008116020	
TCIS-1	Turbine Compact IP Intercom	1008111010	TA-1 Surface Mount Back Box - 1008140010
TCIS-2	Turbine Compact IP Intercom	1008111020	TA-2 Flush Mount 2-Gang Double-Depth Back Box - 1008140020
TCIS-3	Turbine Compact IP Intercom	1008111030	TA-5 Flush Mount Bracket - 1008140050
TCIS-4	Turbine Compact IP Intercom	1008111040	MRBD Multi Relay Board - 1009970200
TCIS-5	Turbine Compact IP Intercom	1008111050	
TCIS-6	Turbine Compact IP Intercom	1008111060	
TCIA-2	Turbine Compact IP Intercom	1008113020	
TKIS-2	Turbine Compact VoIP Intercom Module	1008131020	

Publication Log

Rev.	Date	Author	Status
1.0	21.9.2012	HKL	Published
2.0	24.9.2014	HKL	Turbine Extended intercoms
2.1	5.2.2015	HKL	TFIX-4 intercom
2.4	21.12.2016	HKL	802.1X authentication during upgrade
2.5	3.11.2017	HKL	TFIE-6, VS-IS 4.7
3.0	June 2020	HKL	IC-EDGE

Related Documentation

Doc. number	Mounting Guides
A100K11254	Turbine Compact IP Stations Mounting Guide
A100K11258	Turbine Compact Analog Stations Mounting Guide
A100K11523	Turbine Extended Ex Stations Mounting Guide
A100K11575	Turbine Extended Industrial Stations Mounting Guide
A100K11589	Turbine Mini Mounting Guide
	Connection Guides
A100K11526	TAX-3 Handset for Turbine Ex Connection Guide
A100K11567	TA-23 Handset for Turbine Industrial Connection Guide
A100K11528	EMMAX-1H Compact Microphone for Turbine Ex Connection Guide
A100K11566	EMMAI-2H Compact Microphone for Turbine Industrial Connection Guide
A100K11565	EMMAI-1H Microphone for Turbine Industrial Connection Guide
A100K11525	TAX-2b Plugbox for Turbine Ex Connection Guide
A100K11564	TA-22b Plugbox for Turbine Industrial Connection Guide
	General Manuals
A100K11499	Ex Turbine Intercoms & Exigo Access Panels Installation & Maintenance Procedures
A100K10805	AlphaCom XE Installation & Configuration
A100K11559	Turbine Video TCIV Configuration Manual

Contents

1	Turbine IP Intercoms	5
1.1	Turbine Compact Intercoms	5
1.1.1	TKIS-2 Turbine Kit VoIP Intercom Module	6
1.2	Turbine Extended Intercoms	7
1.2.1	Industrial & Ex	7
1.2.2	ECPIR-3P Indoor Intercom	12
1.2.3	TKIE-2 Turbine Extended Kit	12
2	Intercom Connections	13
2.1	Connectors on Turbine Compact Intercoms	13
2.1.1	Power Supply	13
2.1.2	Network Connection	13
2.1.3	Input/Output Connections	14
2.2	Connectors on Turbine Extended	14
2.2.1	Power Supply	14
2.2.2	Network Connection	15
2.2.3	Input/Output Connections	15
2.3	Connectors on Turbine Ex	15
3	Accessories for Turbine Extended	16
3.1	Connecting Turbine Extended Accessories	16
3.1.1	Opening the TFIE/TFIX Enclosure	16
3.1.2	Connection Terminal Block in Industrial Intercoms	16
3.1.3	Connection Terminal Block in Ex Intercoms	17
3.2	TA-23/TAX-3 Handset for Turbine Extended	17
3.2.1	Connecting TA-23 Handset to TFIE-x Industrial Intercoms	18
3.2.2	Connecting TAX-3 Handset to TFIX-x Ex Intercoms	18
3.3	AK5850HS Headset for Turbine Extended with TA-22b/TAX-2b Plugbox	18
3.3.1	Connecting TA-22b Plugbox to TFIE-x Industrial Intercoms	19
3.3.2	Connecting TAX-2b Plugbox to TFIX-x Ex Intercoms	20
3.4	EMMAI-2H/EMMAX-1H Handheld Compact Microphone for Turbine Extended	20
3.4.1	Connecting EMMAI-2H Microphone to TFIE-x Industrial Intercoms	20
3.4.2	Connecting EMMAX-1H Microphone to TFIX-x Ex Intercoms	21
3.5	EBMDR-8 Expansion Module for ECPIR-3P	21
3.5.1	Connecting EBMDR-8 Expansion Module to ECPIR-3P Intercom	21
3.6	Turbine Relay Module - TA-10	22
4	Starting Up the Station	23
5	ICX-AlphaCom Configuration	24
5.1	Logging into the Station	24
5.2	Main Settings	25
5.3	Audio Settings	27
5.4	I/O Settings	29
5.5	Address Book	30
5.6	OLED Labels	31
5.7	Sound Detection	32
5.8	Time Settings	32
6	IC-EDGE Configuration	33
6.1	Logging into the Station	33
6.2	Main Settings	34
6.3	Connect other Intercom Stations	35
6.4	Configure Edge Controller Directory	35
6.5	Verify System Setup	36
6.6	Configure Call and Audio Settings	36
6.7	Modify IC-EDGE Device Profiles	36
6.8	Group Call	37
6.9	Mobile App Configuration	39
6.9.1	Add the Mobile App to the Edge Controller	39
6.9.2	Global Address List	40
6.9.3	Action Buttons	41
6.10	Configure 3 rd -party SIP Devices	42
6.10.1	Install License	42
6.10.2	Create SIP Account	42
6.10.3	Configure SIP Phone	43
6.10.4	Verify Operation	43
6.11	Advanced Configuration Mode	43
6.12	Direct Access Key & Ringlist Settings	45
6.12.1	Ringlist Settings	46

6.12.1.1 Forward Unattended Call	47
6.12.1.2 Forward Unattended Call with Loopback	48
6.12.1.3 Parallel Ringing - Forward Call if Unattended	49
6.13 Script Settings	50
6.13.1 Script Upload	50
6.13.2 Script Configuration	50
6.13.3 Script Events	51
6.14 Audio Messaging	51
6.14.1 Uploading Audio Files	51
6.14.2 Play Message on DTMF Event	52
6.14.3 Play Message On Call Event	52
6.14.4 Play Message on Relay Event	53
6.14.5 Routing of Audio Message	53
7 SIP Configuration	54
7.1 Logging into the Station	54
7.2 Main Settings	55
7.3 Account/Call Settings	56
7.4 Audio Settings	58
7.5 Direct Access Key & Ringlist Settings	59
7.6 Relay/Output Settings	60
7.7 Time Settings	61
7.8 Audio Messages	61
7.9 Advanced Configuration Mode	62
7.10 I/O Settings	64
8 Common Advanced Network Settings	65
8.1 SNMP Settings	65
8.2 Network Access Control	67
8.3 Firewall Settings	69
9 Station Software Upgrade	70
9.1 Prerequisites	70
9.2 Upgrade via Station Web Interface	70
10 Station Indication LEDs	72
10.1 LEDs on Front Plate	72
10.1.1 Compact Stations	72
10.1.2 ECPIR-3P, Industrial & Ex Stations	72
10.2 Status LEDs on PCB	72
10.3 Ethernet Activity & Speed LEDs	72
11 Restoring Factory Defaults	73
11.1 Reset to Factory Default Settings with Activated DHCP	73
11.2 Reset to Factory Default Settings with Static IP	73
A: Compact Board Connectors	74
A.1 PCB - Front	74
A.2 Input Connectors	75
A.3 Output Connectors + 1 Relay	75
A.4 Output Connectors + MRBD Relay Board	76
A.5 PCB - Rear	76
A.6 Front Board - Front	77
A.7 Front Board - Rear	77
B: Extended Board Connectors	78
B.1 PCB - Front	78
B.2 Input Connectors	78

1 Turbine IP Intercoms

1.1 Turbine Compact Intercoms



TCIS-1
Thermoplastic Frontplate with Single Call Button plus Push-To-Talk & Cancel



TCIS-2/TCIV-2/TCIA-2
Stainless Steel Frontplate with Single Call Button



TCIS-3/TCIV-3
Thermoplastic Frontplate with Single Call Button



TCIS-4
Thermoplastic Frontplate with Single Call Button and PMOLED Display



TCIS-5/TCIV-5
Thermoplastic Frontplate with Two Call Buttons and PMOLED Display



TCIS-6/TCIV-6
Thermoplastic Frontplate with Call & Scrolling Buttons and PMOLED Display



TMIS-1 Turbine Mini
Thermoplastic Frontplate with Single Call Button



TMIS-2 Turbine Mini
Stainless Steel Frontplate with Single Call Button



Figure 1 Turbine TCIS-1 Station Keys & Functions

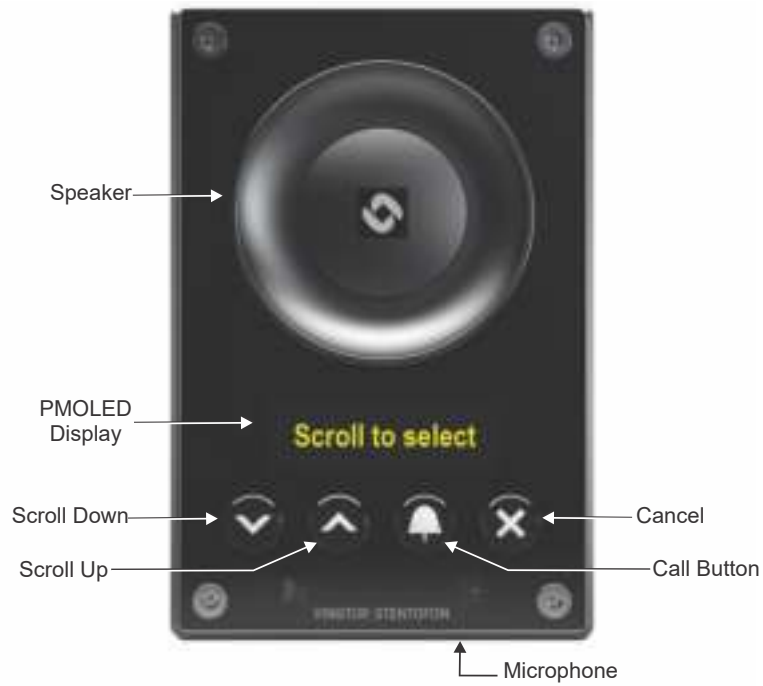

Figure 2 Turbine TCIS-6 Station Keys & Functions

1.1.1 TKIS-2 Turbine Kit VoIP Intercom Module



1.2 Turbine Extended Intercoms

1.2.1 Industrial & Ex



TFIE-1
Industrial Intercom with Full Keypad



TFIE-2
Industrial Intercom with 6 Programmable Keys



TFIE-6
Industrial Intercom with Scrolling Unit & PMOLED Display



TFIX-1
Ex Intercom with Full Keypad



TFIX-2
Ex Intercom with 6 Programmable Keys



TFIX-3
Ex Intercom with Single Call Button plus Push-To-Talk & Cancel



TFIX-4
Ex Intercom with Full Keypad (requires External Speaker)



Figure 3 Turbine TFIE-1/TFIX-1/TFIX-4 Station Keys & Functions

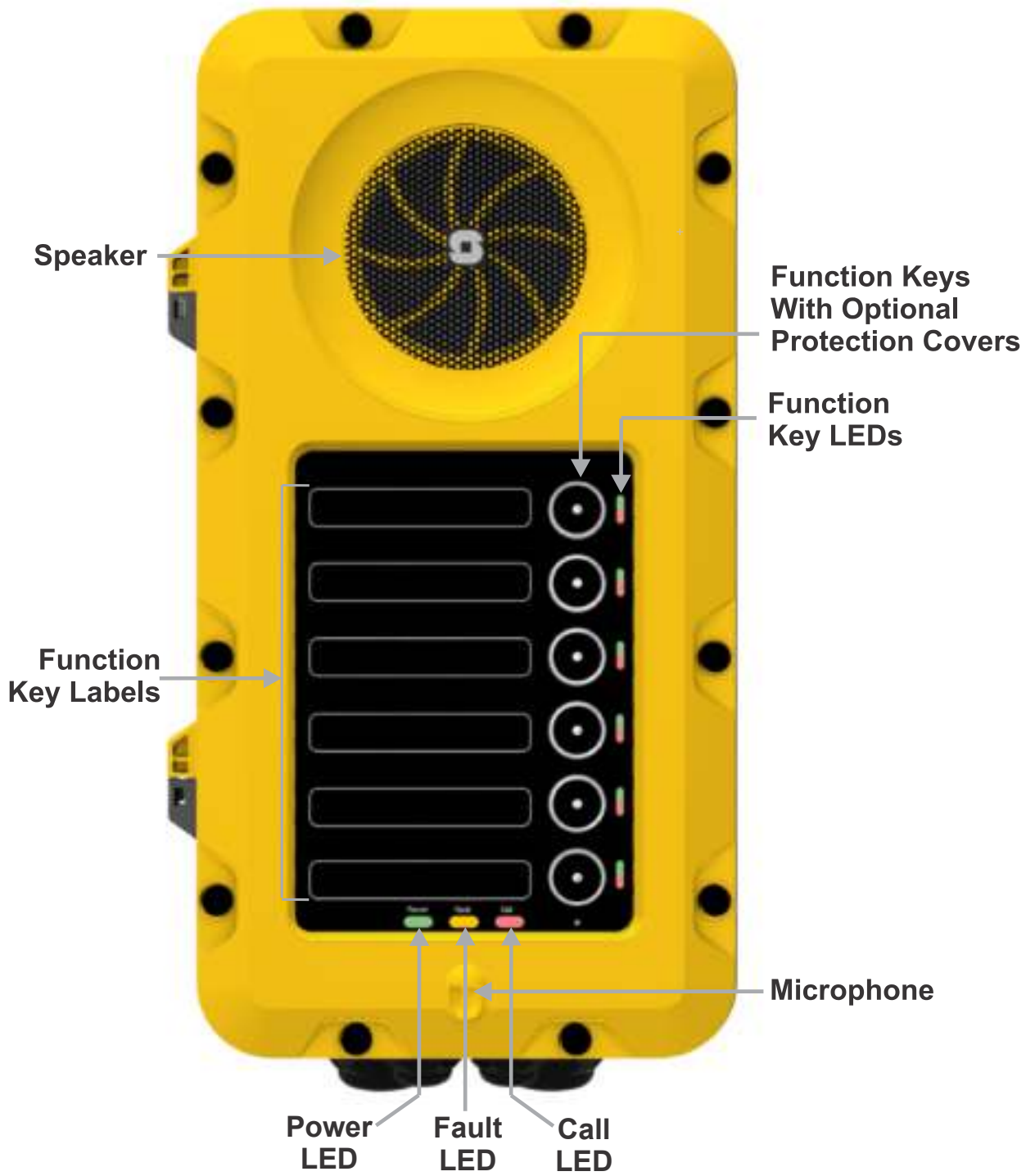

Figure 4 Turbine TFIE-2/TFIX-2 Station Keys & Functions



Figure 5 Turbine TFIE-6 Station Keys & Functions

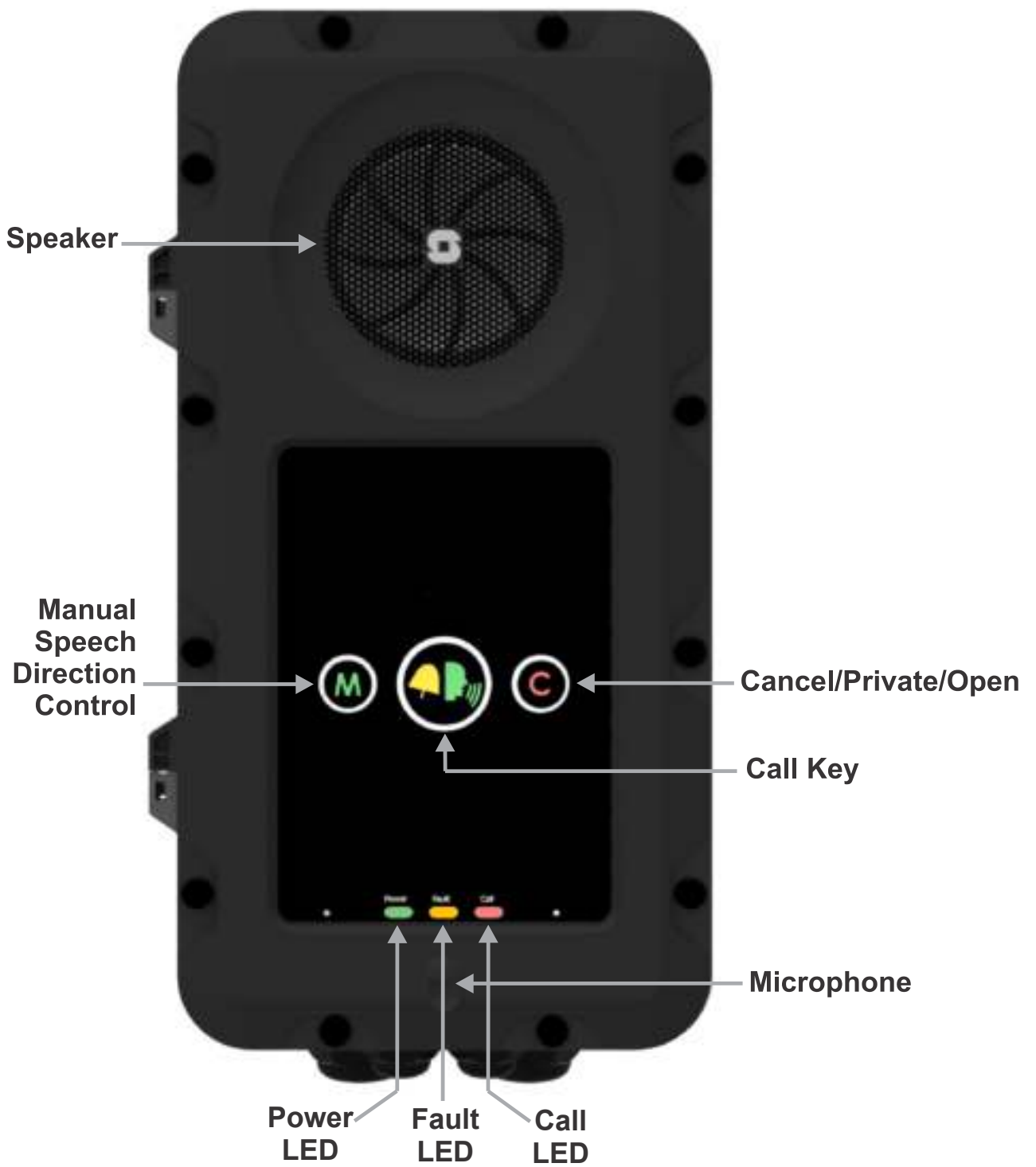

Figure 6 TFX-3 Station Keys & Functions

1.2.2 ECPIR-3P Indoor Intercom

The ECPIR-3P is an Indoor Intercom with 3 programmable keys

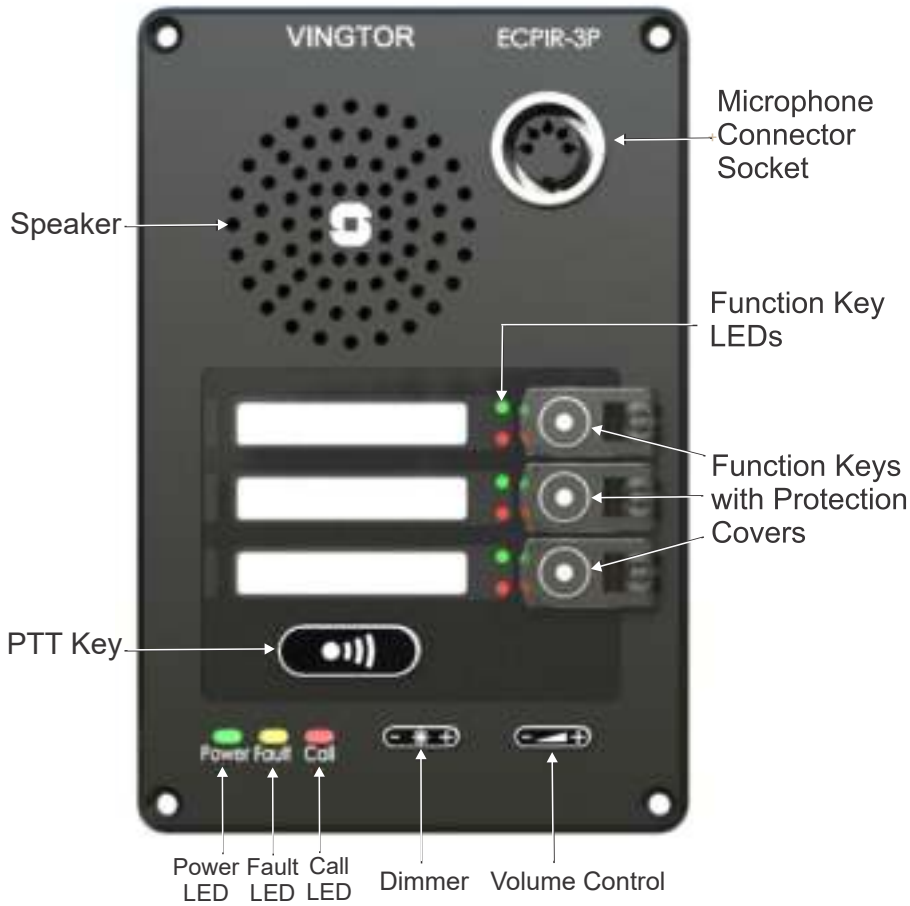

Figure 7 ECPIR-3P Intercom Keys & Functions

1.2.3 TKIE-2 Turbine Extended Kit

The TKIE-2 is the extended version of the Turbine Kit range.



Figure 8 TKIE-2 Connectors & Functions

2 Intercom Connections

2.1 Connectors on Turbine Compact Intercoms

The Turbine Compact Board is used by the following stations: TCIS-1, TCIS-2, TCIS-3, TCIS-4, TCIS-5, TCIS-6, TKIS-2, TMIS-1.

① **Note that the TCIA-2 has a different set of connectors**

See *Appendix A: Compact Board Connectors* for further information.

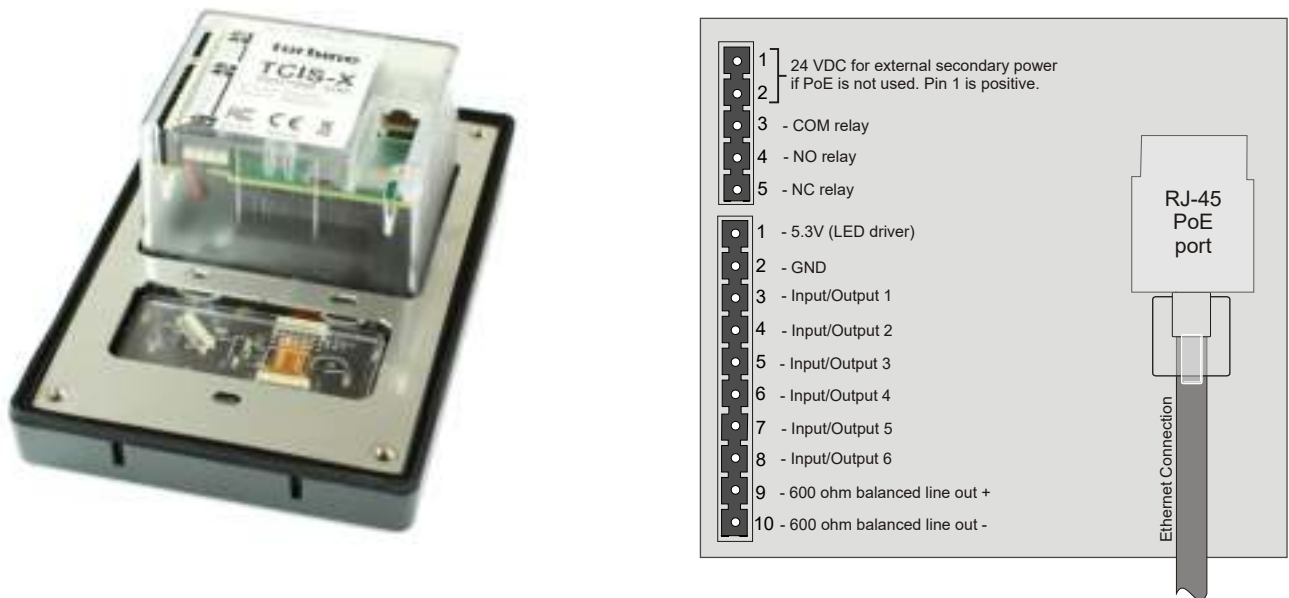

Figure 9 Connectors on Turbine Compact Station

The following table is an overview of the main connectors involved when installing the Turbine IP Stations.

Ethernet / Power	10/100 Mbps Ethernet RJ-45 port for LAN (uplink) connection. Supports PoE (802.3af). Draws power from either spare line or signal line.
Secondary Power	24 VDC (16 – 48 V) secondary power is provided from an external adapter.
Relays	There is one Double Throw relay contact with 60W switching power. COM, NO, NC contacts are provided. Max: 250VAC/220VDC, 2A, 60W.
Input/Output	6 general purpose I/Os are available. Each I/O can be configured as either button input or LED driver.
Audio Line Out	A balanced 600 ohm audio line out with induction loop signal

2.1.1 Power Supply

The Turbine Compact Station supports Power over Ethernet (PoE, IEEE 802.3 a-f) where power can be drawn from either the spare line or signal line. If PoE is not available, the Turbine Compact Station can be connected to a 24 VDC local power supply.

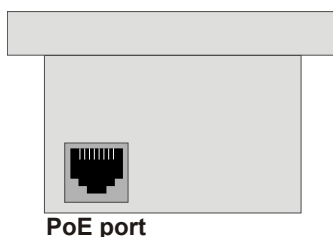

2.1.2 Network Connection

There is one RJ-45 port located on the Turbine Compact station that is used for PoE/LAN Ethernet connection.

2.1.3 Input/Output Connections

There are 6 I/O connection options for the Turbine Compact Station.

These connections can be used to interface with external I/O devices. The connections are typically used as digital input (eg. form a closing contact), digital output (5V), or LED driving (20mA max) for connecting sensors, indicators or integration to other systems. See *Appendix A* for further information.

2.2 Connectors on Turbine Extended

The Turbine Extended board is used in the following stations: TFIE-1, TFIE-2, ECPIR-3P, TKIE-1, TFIK-1, TFIK-2, TFIK-3, TFIK-4.

See *Appendix B: Extended Board Connectors* for further information.

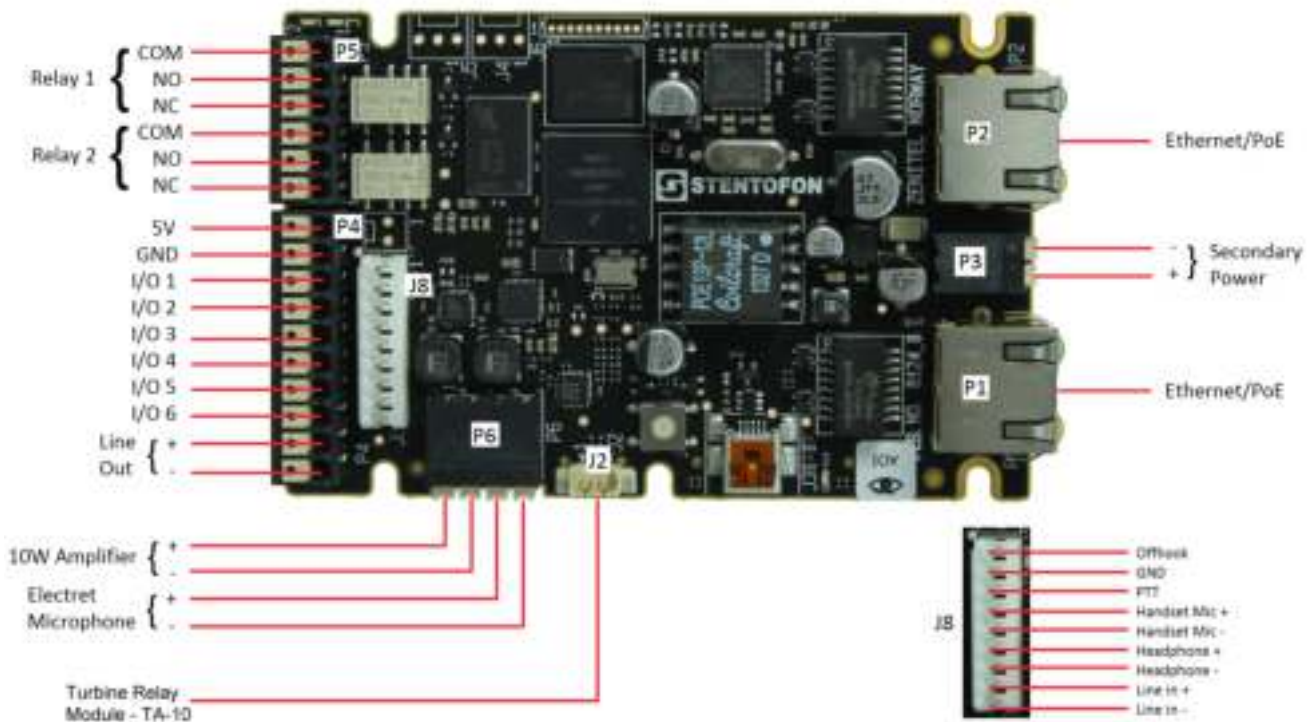

Figure 10 Connectors on Turbine Industrial Station

- ① All connections are made on the main board inside the enclosure of the Turbine Industrial station.

2.2.1 Power Supply



The Turbine Industrial Station supports Power over Ethernet (PoE, IEEE 802.3 a-f) where power can be drawn from either the spare line or signal line.

If PoE is not available, the Turbine Industrial Station can be powered from a 24-48 VDC local power supply.

- ① If used together with PoE the station can be powered by 24 VDC as a local power backup.
- ① If connected to two PoE-capable switches, only one of the ports will negotiate PoE; hence this is not a good solution for power redundancy (switch failure might lead to a reboot). Instead a “dumb” PoE injector (spare-pair power) should be used for the two Ethernet ports or a local 24 VDC local power backup.

2.2.2 Network Connection

There are two RJ-45 ports located on the Turbine Industrial station, either of which can be used for a single PoE/LAN Ethernet connection.

2.2.3 Input/Output Connections

There are 6 I/O connection options for the Turbine Industrial Station.

These connections are used as digital input (eg. form a closing contact), digital output (5V), or LED driving (20mA max) for connecting sensors, indicators or integration to other systems. See *Appendix B: Extended Board Connectors* for further information.

2.3 Connectors on Turbine Ex

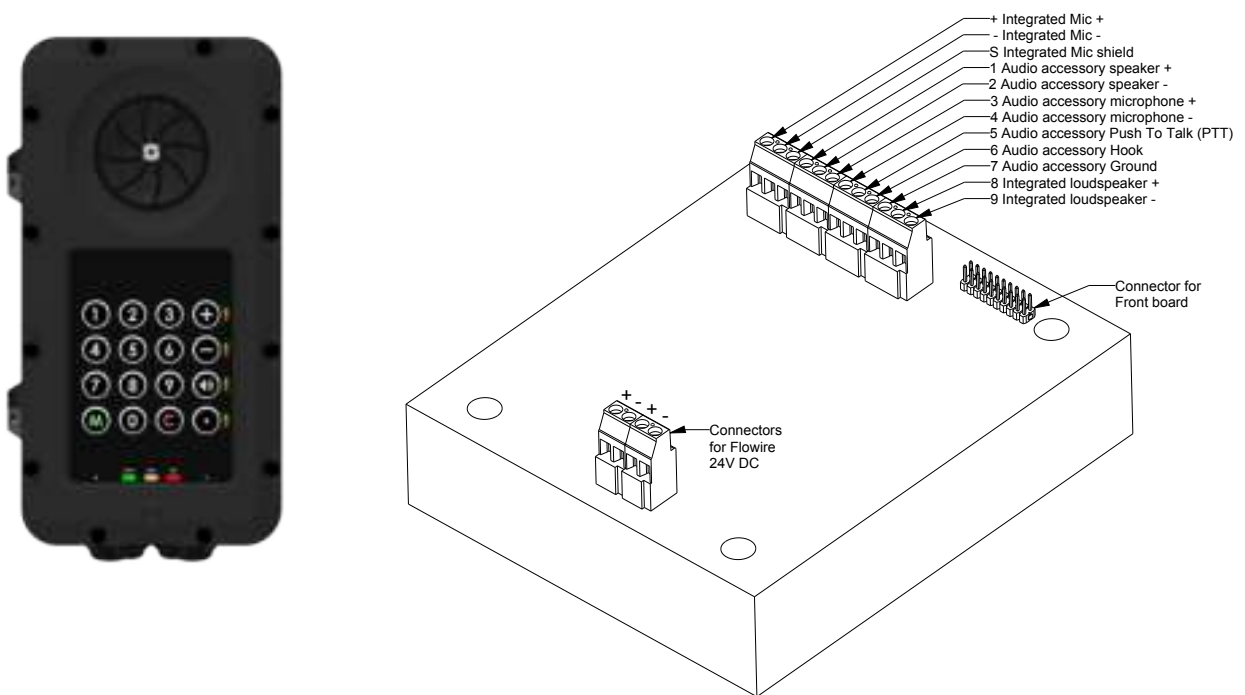

Figure 11 Connectors on Turbine Ex Station

① **All connections are made on the main board inside the enclosure of the Turbine Ex station.**

Procedures for connecting power supply, LAN network and Inputs/Outputs are described in the manual *A100K11499 Ex Turbine Intercoms & Exigo Access Panels Installation & Maintenance Procedures*.

3 Accessories for Turbine Extended

3.1 Connecting Turbine Extended Accessories

Accessories such as the handset, plugbox for the headset, and handheld microphones are connected to the connection terminal block J8 on the main board inside the station enclosure. Follow the instructions for opening the enclosure in the section below.

3.1.1 Opening the TFIE/TFIX Enclosure

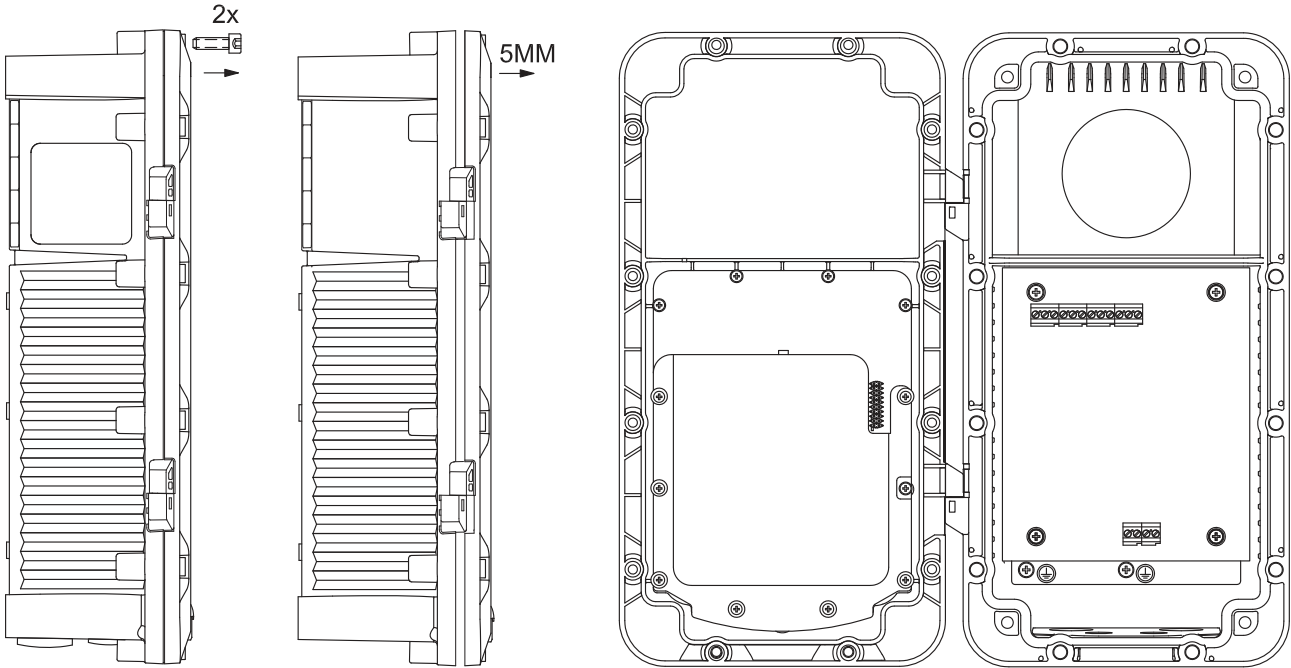

1 Open the enclosure by loosening the 2 screws that secure the front frame to the on-wall box

2 Open the enclosure by pulling the front frame out 5 mm, keeping it parallel to the on-wall box. This is necessary to get clearing for the hinges.

3 Then pull the right side of the front frame to fully open the enclosure. Make sure to not open the enclosure so far that cables between the front and back parts are pulled tight.

3.1.2 Connection Terminal Block in Industrial Intercoms

Accessories are connected to the 9-pin connection terminal block J8 on the main board in the Turbine Industrial enclosure.



3.1.3 Connection Terminal Block in Ex Intercoms

Accessories are connected to the 12-screw connection terminal block in the Turbine Ex enclosure.

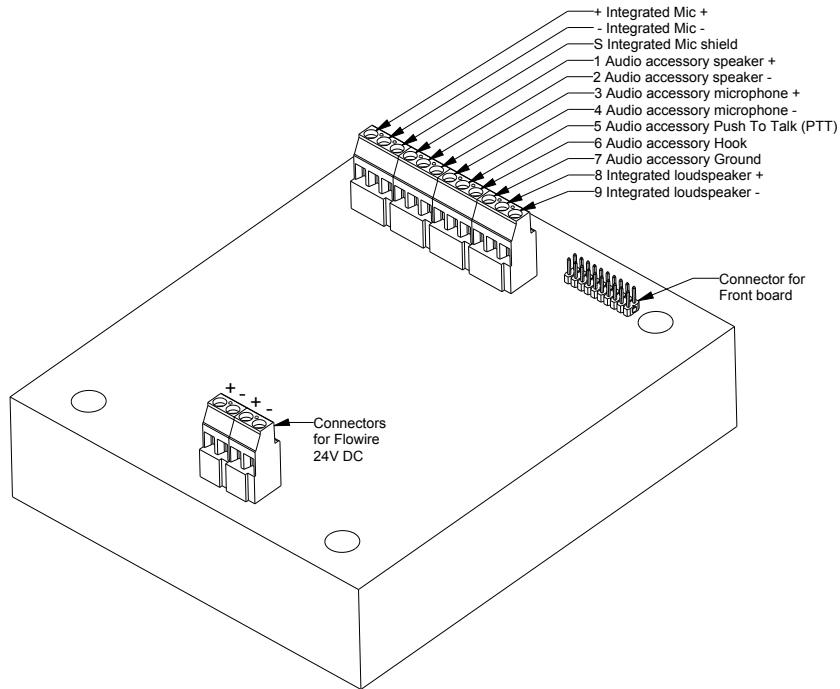

3.2 TA-23/TAX-3 Handset for Turbine Extended

The handset comes with a Push-To-Talk (PTT) button and 3.5-meter long cable.

- TA-23: used with Turbine Industrial intercoms
- TAX-3: used with Turbine Ex intercoms

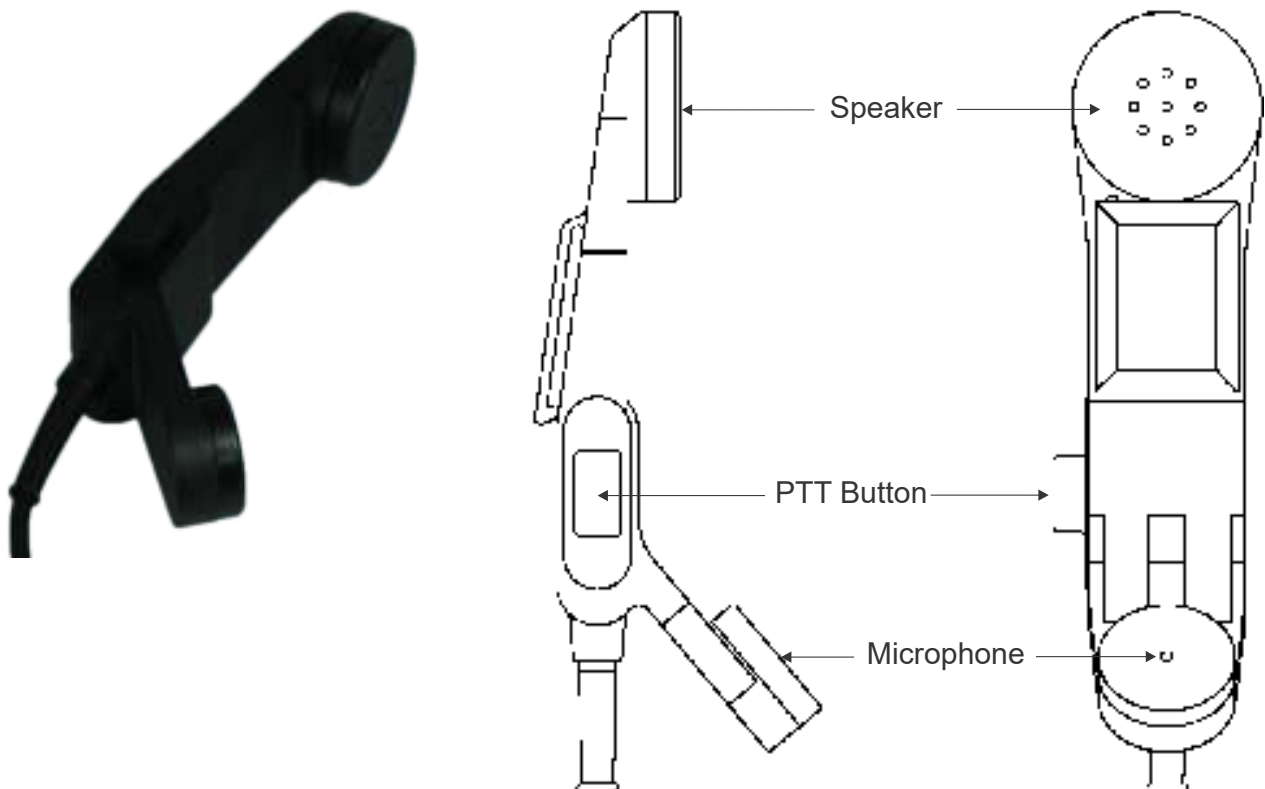
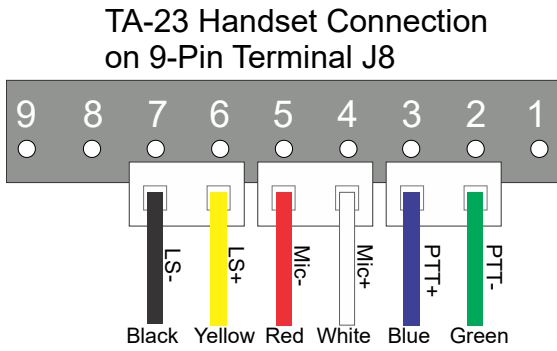

Figure 12 TA-23/TAX-3 Handset

3.2.1 Connecting TA-23 Handset to TFIE-x Industrial Intercoms

Plug the IDC connectors on the Handset cable into the J8 terminal block according to the pin configuration below.



3.2.2 Connecting TAX-3 Handset to TFIx-x Ex Intercoms

Connect the wire ferrules on the Handset cable to the terminal block according to the pin configuration below.

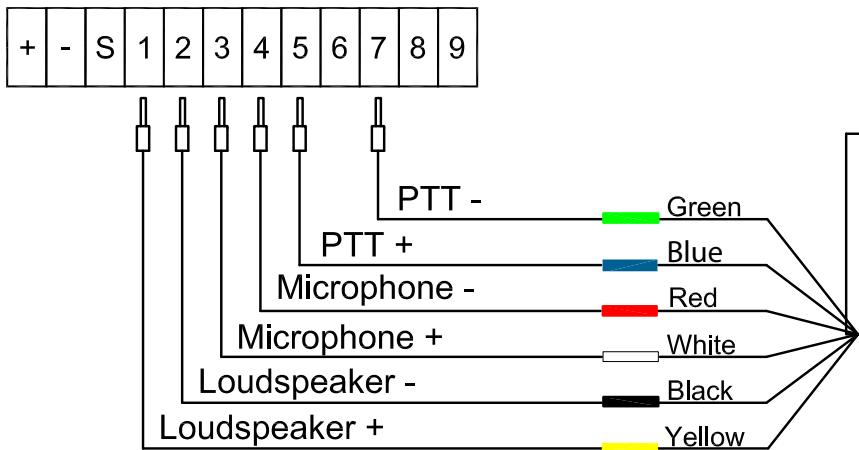

3.3 AK5850HS Headset for Turbine Extended with TA-22b/TAX-2b Plugbox

The Headset comes with a boom microphone, curled cord and plug.

The Plugbox comes with a PTT button and 10-meter long cable.

- TA-22b: used with Turbine Industrial Intercoms
- TAX-2b: used with Turbine Ex Intercoms



Figure 13 AK5850HS Headset with TA-22b/TAX-2b Plugbox

3.3.1 Connecting TA-22b Plugbox to TFIE-x Industrial Intercoms

Plug the IDC connectors on the Plugbox cable into the J8 terminal block according to the pin configuration below.

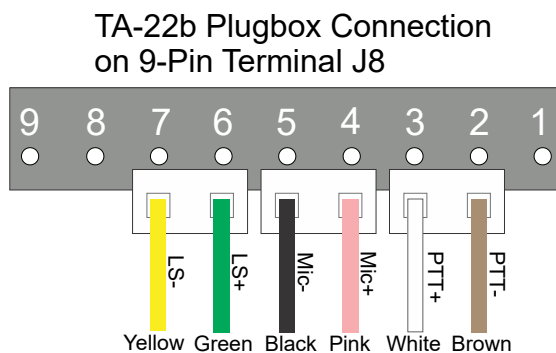

3.3.2 Connecting TAX-2b Plugbox to TFIX-x Ex Intercoms

Connect the wire ferrules on the Plugbox cable to the terminal block according to the pin configuration below. Note that the black (shield) wire is labeled **MIC-** and the black (main shield) wire is labeled **GND**.

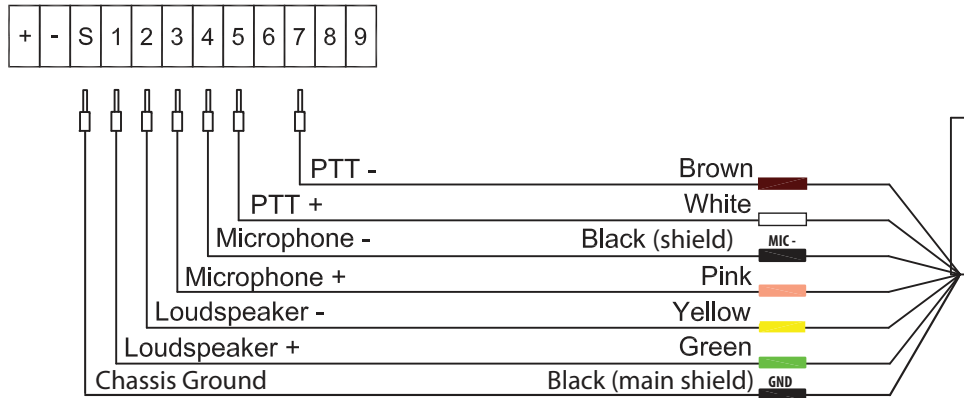

3.4 EMMAI-2H/EMMAX-1H Handheld Compact Microphone for Turbine Extended

The Compact Microphone comes with a Push-To-Talk (PTT) button and 3-meter long cable.

- EMMAI-2H: used with Turbine Industrial intercoms
- EMMAX-1H: used with Turbine Ex intercoms



3.4.1 Connecting EMMAI-2H Microphone to TFIE-x Industrial Intercoms

Plug the IDC connectors on the Compact Microphone cable into the J8 terminal block according to the pin configuration below.

EMMAI-2H Microphone Connection on 9-Pin Terminal J8

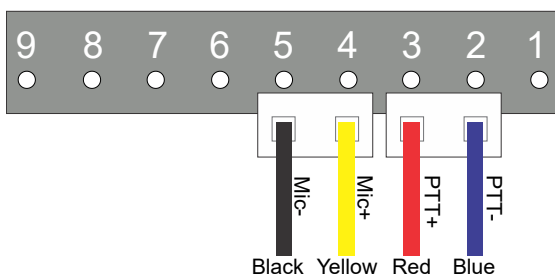

3.4.2 Connecting EMMAX-1H Microphone to TFIX-x Ex Intercoms

Connect the wire ferrules on the Compact Microphone cable to the terminal block according to the pin configuration below.

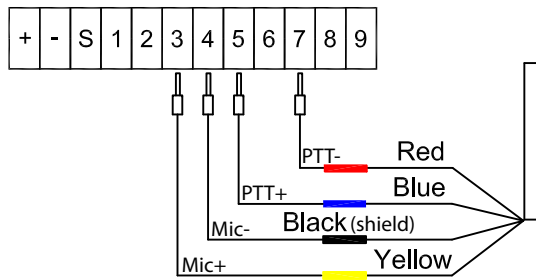

3.5 EBMDR-8 Expansion Module for ECPIR-3P

The EBMDR-8 Expansion Module is a slave unit to the ECPIR-3P. The EBMDR-8 hence receives power from and communicates through its master, the ECPIR-3P.

- ① *Up to four EBMDR-8 modules may be daisy-chained to one ECPIR-3P*



3.5.1 Connecting EBMDR-8 Expansion Module to ECPIR-3P Intercom

1. Using the small connection cable supplied, connect the EBMDR-8 expansion module to the ECPIR-3P or preceding module as shown in the figure.
 - If more than one EBMDR-8 is connected to the same ECPIR-3P, these are daisy-chained together.
2. Connect the white connector on the cable to the corresponding white connector on the ECPIR-3P or preceding EBMDR-8.
3. Connect the black connector on the cable to the corresponding black connector on the EBMDR-8.



3.6 Turbine Relay Module - TA-10

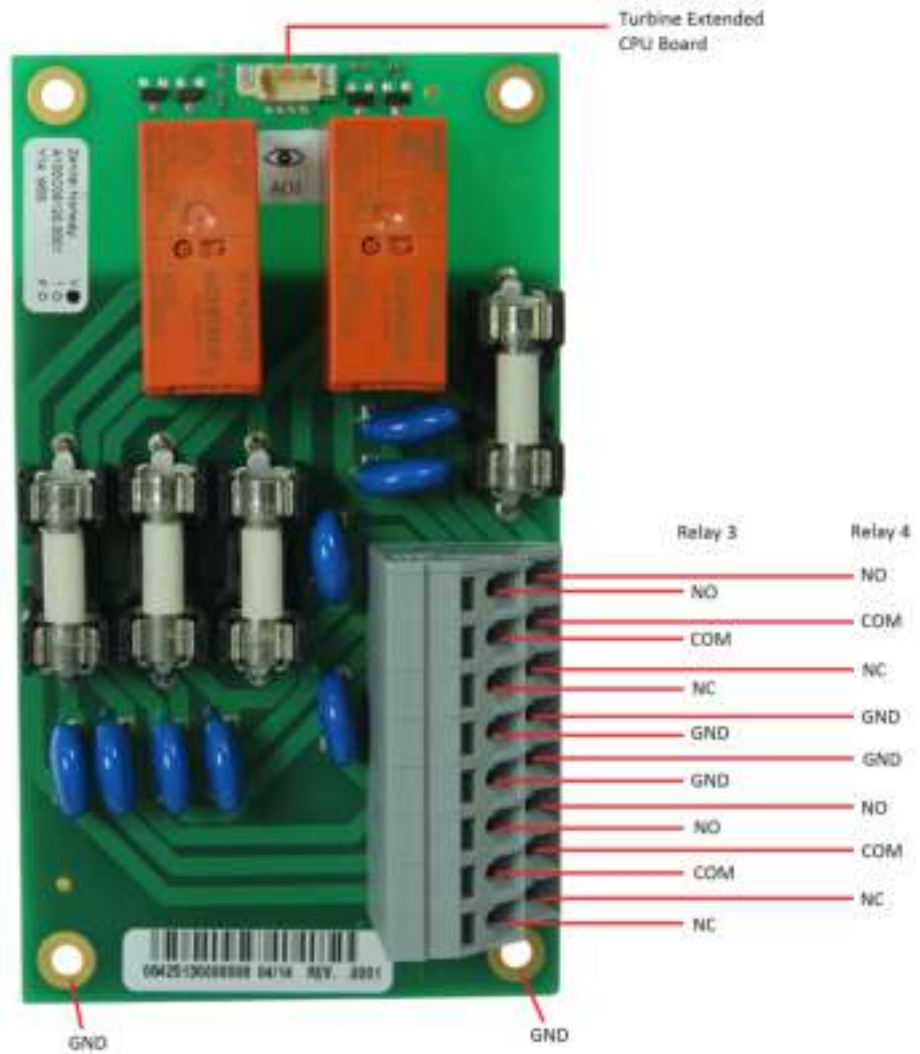

4 Starting Up the Station

The Turbine Station features an embedded web interface, which allows users to log in via a standard web browser.

To start up the station, your PC and the IP station have to be connected together via a PoE switch using network cables:

1. Connect the PC to the PoE switch
2. Connect the PoE port on the IP station to the PoE switch

When the Turbine Station is connected to the network, the **IP address** of the station is automatically obtained in one of two ways:

1. An IP address is obtained from a **DHCP server** if there is one.
2. If there is no DHCP server, an IP address in the range **169.254.x.x** will be assigned.

To make the station speak its IP address:

- Press the **call key**, **number keys** or **DAKs** on the station
 - when the station is not yet registered

At commissioning, the IP station needs to be configured to enable it to be used as:

- Station subscribed to an ICX-500 Intelligent Communication Gateway or AlphaCom XE server
- SIP station
- IC-EDGE station

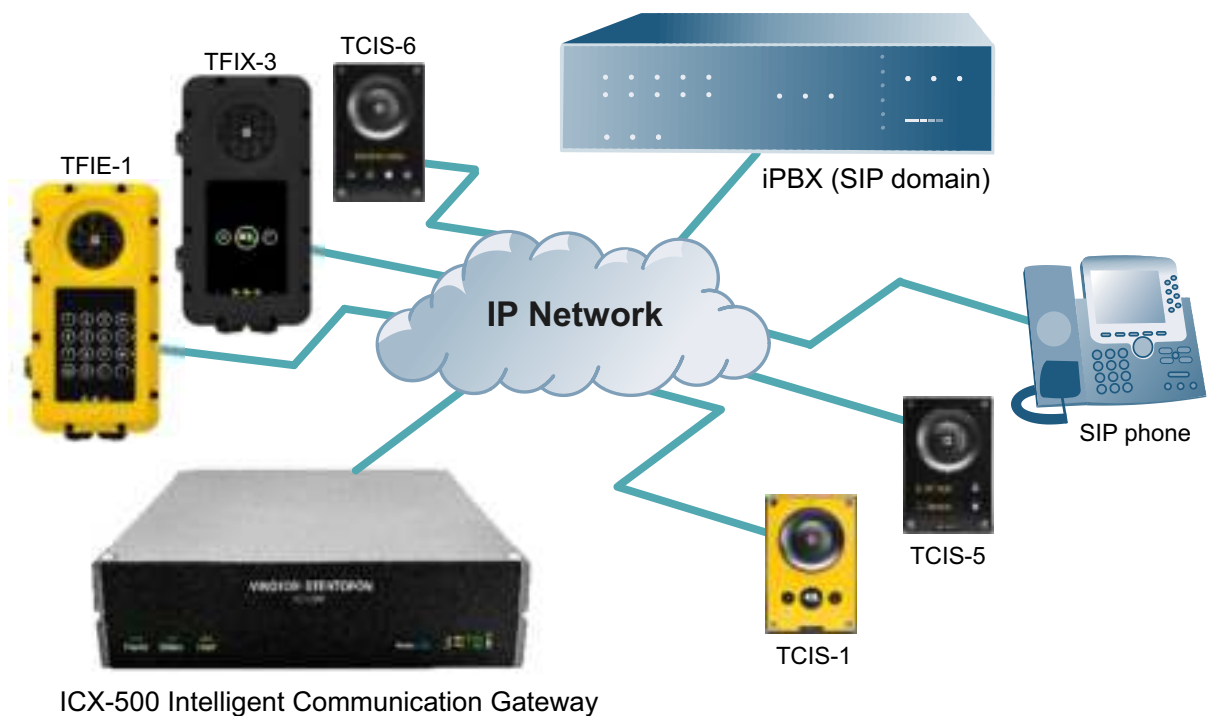

5 ICX-AlphaCom Configuration

The Turbine stations are connected to the ICX-AlphaCom platform comprising the ICX-500 Intelligent Communication Gateway or AlphaCom XE server/exchange lying at the heart of our security and communication system. The communication between the ICX-AlphaCom platform and the Turbine Stations utilize the CCoIP® protocols. The ICX-AlphaCom platform includes all main service configurations for the IP stations and only a minimum configuration is needed to be carried out on the actual station.

For more information on ICX-AlphaCom configuration see wiki.zenitel.com/wiki/Turbine_Configuration_-_AlphaCom_mode



Figure 14 ICX-AlphaCom Intercom System

The following sections describe configuration procedures using the web interface of the station.

5.1 Logging into the Station

Ensure that the IP address of your PC is in the same range as that of the station IP address. Access the station by logging into the web interface using a standard web browser on your PC:

1. Open a web browser
2. In the browser's address bar, type the station IP address and press the ENTER key
 - The station login page will be displayed.

To log into the station:



1. Click **Login**
2. Enter the default User name: **admin**
3. Enter the default Password: **alphaadmin**

The **Station Information** page will now be displayed, showing the IP station configuration and status.



Note that the user interface and parameters displayed in the following sections are dependent on the Turbine station type (Compact, Industrial or Ex) selected.

5.2 Main Settings

To access the page for configuring station mode and IP parameters:

- Select **Main > Main Settings**

Mode

Select preferred mode for your device. If your system is Edge, please log on to the device you will use as the Edge Controller. You can do all configuration of your devices from the Edge Controller.

ICX-AlphaCom

Ergo

gpr

Edge

Edge Controller

Product Model And Accessory

Model: Normal (TCIS-1, TCIS-2, TCIS-3) ▼

Registration Settings

ICX-AlphaCom IP-Address: 10 - 9 - 5 - 90 Number: 101

IP Settings

DHCP State IP

IP Address:	10	9	5	101
Subnet Mask:	255	255	255	0
Gateway:	10	9	5	1
DNS Server 1:	200	200	200	200
DNS Server 2:	200	200	200	200
Hostname:	zenite064528			
Disable Reset to Factory default settings using frontboard and I/O:	<input type="checkbox"/>			
Read IP Address:	<input type="checkbox"/>			
Ethernet Speed 10 Mbit/s:	<input type="checkbox"/>			

SAVE

Mode

- Select the **ICX-AlphaCom** radio-button

Product Model and Accessory

The options presented will depend on the Turbine model (Compact, Industrial, Ex).

- Select one of the options from the **Model** drop-down box:

Model: (for Compact)

- Kit (TKIS-2)
- Normal (TCIS-1, TCIS-2, TCIS-3)
- OLED Labels (TCIS-4, TCIS-5)
- Scrolling Station (TCIS-6)
- Mini (TMIS-1, TMIS-2)

Model: (for Extended)

- TKIE-1 (Kit)
- TFIE-1
- TFIE-2
- TFIE-6
- ECPIR-3P

Model: (for Ex)

- TFIX-1
- TFIX-2
- TFIX-3
- TFIX-4

Accessory: (for Extended & Ex)

- Handset
- Handset w/ Offhook
- Handset w/ Offhook (Normally Closed)
- Handheld Microphone
- Headset
- Headset w/ Autodetect

Registration Settings

ICX-AlphaCom IP-Address:

- Enter the IP address of the ICX-500 or AlphaCom serve in which the IP station is to be a subscriber in the field.

Number:

- Enter the directory number of the station in the field.
 - If a directory number is not entered, the station will register with its MAC address. The MAC address is found on the **Station Information** page and needs to be entered into AlphaPro.

IP Settings

- **DHCP** – Select this option if the IP station shall receive IP Settings from a DHCP server.
- **Static IP** – Select this option if the IP station shall use a static IP address. Enter values for:
 - **IP-address**
 - **Subnet-mask**
 - **Gateway**
 - **DNS Server 1** (option for network administration)
 - **DNS Server 2** (option for network administration)
 - **Hostname** (option for network administration)

Disable Reset to Factory default settings using frontboard and I/O

- Check the box to disable factory reset using frontboard and I/O

Read IP Address

- **Read IP Address** enables an unregistered station to speak the IP address when the call button is pressed. **Read IP Address** box is checked, i.e. enabled, by default.

Ethernet Speed 10 Mbits/s

- Check the box if the switch is configured to 10 Mbit/s. Default Ethernet speed is 100 Mbit/s.

Enable RSTP (for Industrial & Ex)

- Check the **Enable RSTP** box to enable RSTP
 - RSTP is only required when using redundant networking

- Click **SAVE** followed by **APPLY**

5.3 Audio Settings

- Select **Advanced ICX-AlphaCom > Audio**

Main Station Administration Advanced ICX-AlphaCom Advanced Network			
Audio Settings			
Audio	Description	Configuration	
• DAMC Settings	Volume Override Level:	8 ▼	Sets the volume during volume override. Volume and handset override happens during Emergency Group calls.
• Offline Relay	Microphone Sensitivity:	2 ▼	Default value 4. 0 = very low sensitivity
• I/O Settings	Digital/Analog Mic Switch:	Always Digital ▼	Default is Always Digital. Switch from Digital to Analog Mic based on settings. Analog I/O Pin: When I/O Pin is triggered, Analog Mic is used, when not Digital Mic is used. Analog I/O Pin Call End: Analog Mic is switched On (Digital Off) by first I/O Pin trigger in call and used until call end.
• Keyboard Settings	Digital/Analog Mic Switch Pin:	None ▼	Input/Output Pin for Digital/Analog Mic switching. This doesn't affect other I/O pin configured functionality. NOTE: Pin must be configured as Input.
• Sound Detection	Mute speaker while analog mic:	<input type="checkbox"/>	Mute speaker while Analog Mic is used.
• RTSP Settings	Voice Engine Mode:	Voice ▼	Default is Voice. Use HD-Audio only on devices that handle high quality music streaming/playback. NOTE: Changing this will reboot main application.
• Time Settings	Volume Control Ch1:	0	Audio Channel 1 Offset Gain (default routed to Amplifier/Speaker). Valid range: [-62, +24] dB
• Audio Messages	Volume Control Ch2:	0	Audio Channel 2 Offset Gain. (default routed to Line Out Amplifier). Note: In Standard Turbine ch2 is same signal as ch1. Valid range: [-62, +24] dB
	Conversation Mode:	Full Open Duplex ▼	
	Audio profile:	Normal ▼	
	Hardware AGC:	Disabled ▼	Select Manual Control to enter own values.
	Hardware DRC:	<input type="checkbox"/>	Dynamic Range Compression
	Automatic Gain Control (AGC):	<input type="checkbox"/>	Automatic Gain Control. If speech level and environmental noise are very unstable it may be turned on.
	Audio Out Source:	Voice Audio ▼	Main Audio Out (Speaker) Source
	Line Out Source:	Audio Ch2 ▼	Line out can play audio either from VoIP signal or direct from microphone
	Add number of "Mixer Channels":	8 ▼	ICX-AlphaCom Multi-Conference Mixer function.
	Automatic Volume Control (AVC):	<input type="checkbox"/>	Volume depends on noise level
	AVC Debug:	<input type="checkbox"/>	Shows current volume level on OLED display
	AVC Advanced:	<input type="checkbox"/>	Check to open advanced settings
	Far-End Audio Squelch:	Disabled ▼	Audio Squelch on Far-End Signal (suppress audio on low signal levels)
	Squelch Threshold:	-60	Threshold level for suppressing audio signal. Valid range: [-62, 0] dBm0
	Squelch Activate Delay:	100	Delay time with signal below threshold level before squelch is activated. Valid range: [0, 10000] ms
SAVE			

- Select or set values for the parameters

Volume Override Level

- Select the Volume Override Level in the range 0 to 8 from the drop-down box. The default setting is 7.

Microphone Sensitivity

- Select the sensitivity level in the range 0 to 7 from the drop-down box. The default setting is 4.
① *If used as a local PA panel, a setting in the 1 to 3 range will reduce the chance of acoustic feedback (howling).*

Digital/Analog Mic Switch

- Switches from Digital to Analog Mic based on settings.
- Options: **Always Digital** (Default), **Always Analog**, **Analog I/O Pin**, **Analog I/O Pin Call End**
- **Mute speaker while analog mic**

Voice Engine Mode

- **Voice**: Regular audio quality (default).
- **HD-Audio**: Play audio in PCM L16/48kHz format. Use **HD-Audio** only on devices that handle high quality music streaming/playback, typically IP loudspeakers and Turbine kits used as PA interface.

Volume Control Ch1/Ch2

- Offset Gain (default routed to Amplifier/Speaker)
- Valid range: -62 to +24 dB



This feature must be used with caution as incorrect settings may severely degrade the performance of the echo-cancelling algorithm.

Conversation Mode

For this parameter, there are five options:

- **Full Open Duplex:** Normal mode with echo cancellation
- **Robust Duplex:** Option used when open duplex fails due to excessive speaker loudness, microphone overload or very high nonlinear distortions.
- **Half Duplex Switching:** Switches speech direction depending on who speaks the loudest
- **Push-To-Talk:** Half-duplex communication. Initially the microphone is shut off. Push the M-button to open the microphone, and release to listen. (Only applicable to stations with M-key)
- **Open:** Full Open Duplex without echo cancellation

Audio Profile

- **Normal:** Standard Acoustic Echo Cancelling (AEC) Profile with a few extra filters added to try to minimize the effects on the voice-signal when operating in a standard environment.
- **Noisy Environment:** Environment with high noise levels but maximum speaker level is not required.
- **Very Noisy Environment:** Extreme environment with very high noise level and maximum speaker level is required.

Hardware DRC

Enables **Dynamic Range Compression**

Hardware AGC

Enables **Automatic Gain Control**. Options are **Disabled, Quiet Area, Noisy Area, Manual Control**.

- When selecting Manual Control, there will be more advanced AGC parameters available.

Automatic Gain Control (AGC)

If speech level and environmental noise is very unstable, it may be turned on.

- **AGC Speed:** 0..3 selects different attack/release times. Lesser values mean faster attack and slower release time.
- **AGC Volume:** 0..7 corresponds to -20..0 dBm

Audio Out Source

Main audio out (speaker) sources:

- **Voice Audio:** Plays audio from VoIP signal
- **LineIn Idle:** Plays audio from the Line IN input when the station is in idle. During a call, plays audio from the VoIP signal.
- **LineIn Idle + GPIO-6:** If input 6 is activated while the station is in idle, plays audio from the Line IN input. Otherwise, plays audio from the VoIP signal.

Audio Input Source (Turbine Extended only)

- **Normal Microphone** (default): Select this option when using an electret microphone as audio source. On the TKIE kit, the microphone is connected to connector P6, pins 3 & 4.
- **Line In:** Select this option when using an external audio source with line level. On the TKIE kit, the line Input is on connector J8, pins 8 & 9.

Line Out Source

Line Out can play audio either from VoIP signal or directly from microphone.

- **Audio Ch2:** Plays audio from VoIP signal.
- **Microphone before AEC:** The analog and digital (only 4.7 software) microphone signal is sent to Line Out. The loudspeaker signal is picked up by the microphone through the air, and also sent to the Line Out. There is no signal processing done.
- **Microphone after AEC:**
If the station is in Open Mode: The microphone signal is sent to Line Out. The speaker signal is picked up by the microphone through the air, and also sent to the Line Out. Echo Cancelling won't work, but Noise Reduction works. Audio from mic should be heard all the time on Line Out, while audio from other party should be heard only when PTT is pressed by said party.
If the station is in Full Duplex Mode: The microphone signal is sent to Line Out.

Add number of “Mixer Channels”

ICX-AlphaCom Multi-Conference Mixer function.

Automatic Volume Control (AVC)

Automatically adjusts the volume according to background noise level.

AVC Debug

Shows current volume level on OLED display.

AVC Advanced

- **AVC Lower Threshold:** Threshold level for AVC starts working. Valid range: [-92..0] dBm0
- **AVC Upper Threshold:** Threshold level for AVC stops working. Valid range: [-92..0] dBm0
- **AVC Attack Rate:** How fast gain is raised when ambient noise level is increasing. Valid range: [0..100] 1/10th db/sec ([0.1..10] dB/sec)
- **AVC Decay Rate:** How fast gain is reduced when ambient noise level is falling. Valid range: [0..100] 1/10th db/sec ([0.1..10] dB/sec)
- **AVC Hysteresis:** Required mic signal change level before new gain is adjusted. This is applied when there is a change in gain directions. Valid range: [1..10] db
- **AVC Lockout Time:** Time for successive frames after AVC lock, due to far-end active or optional high near-end signal, before commencing AVC adjustments. A negative sign locks AVC if signal is above upper threshold. Valid range: [1..10] db

Far-End Audio Squelch

Enables Audio Squelch on Far-End Signal (suppresses audio on low signal levels).

Squelch Threshold

Signal level below this threshold will be suppressed to silence. Range is 0dB to -92dB. Default is -60dB.

Squelch Activate Delay

Delays time with signal below threshold level before squelch is activated. Squelch is turned off again on first audio frame with level above threshold. This will implement a simple hysteresis hindering too rapid on/off with a signal changing around threshold.

5.4 I/O Settings

The I/Os can either be configured as an Input or as an Output. By default all I/Os are set as Inputs.

- Select **Advanced ICX-AlphaCom > I/O Settings**

Description	Configuration
Fast Blink Pattern	111000111000111000111000
Slow Blink Pattern	111111111111100000000000
I/O Pin 1:	Input 1
I/O Pin 2:	Input 2
I/O Pin 3:	Input 3
I/O Pin 4:	Input 4
I/O Pin 5:	Input 5
I/O Pin 6:	Input 6
Relay:	Pin Number ?

Fast Blink Pattern

- Set the fast blink pattern for the LEDs

Slow Blink Pattern

- Set the slow blink pattern for the LEDs

- Select either **Input** or **Output** options from the drop-down box for **I/O Pins 1 to 6**

5.5 Address Book

① *Note that only the Turbine Compact station configured as a Scrolling Station (TCIS-6, TCIV-6, TFIE-6) under Main Settings will have this menu option.*

- Select **Advanced ICX-AlphaCom > Address Book**

Main | **Station Administration** | **Advanced ICX-AlphaCom** | **Advanced Network**

Address Book

Description	Configuration	
Display Text:	Scroll to Select	
Font Size	12 ▼	
OLED Brightness	Default ▼	Higher brightness reduces OLED lifetime
Start Scrolling After:	5 minutes	0 is off. Scrolling increases OLED lifetime
Menu Text Color	Dark ▼	
Sort Address Book	OFF ▼	
Show Number:	No ▼	

Download or View Address Book: **DOWNLOAD** **VIEW**

SAVE

Upload Address Book

Description	Configuration	
Upload Address Book:	Choose File	No file chosen Must be .csv file with format: number;text

SAVE

Warning: Uploading new address book will delete existing address book entries.

Address Book Entries

Number	Name	
<input type="text"/>	<input type="text"/>	ADD

SAVE

Display Text

- The idle text shown in the display may be changed. The default text is: **Scroll to Select**

Font Size

- The font size can be either **12** or **16**

OLED Brightness

- Select Brightness levels: **Extra Dim, Dim, Default, Bright, Extra Bright, Max Brightness**

Start Scrolling After

- Set the time in minutes, after which horizontal scrolling of the display text should start.

Menu Text Color

- The text color can be either **Dark** or **Light**

Sort Address Book

- Sort according to: **Name Ascending/Descending, DrNo Ascending/Descending**

Show Number

- Set: **No** or **Yes**

Download or View Address Book

- **DOWNLOAD** or **VIEW** the address book

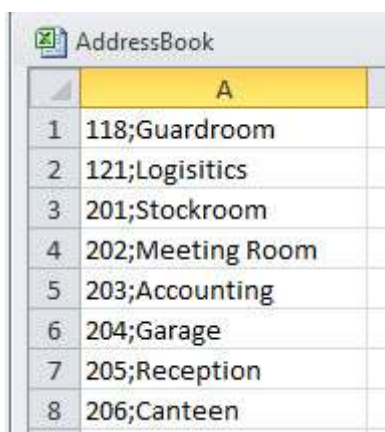

	A
1	118;Guardroom
2	121;Logisitics
3	201;Stockroom
4	202;Meeting Room
5	203;Accounting
6	204;Garage
7	205;Reception
8	206;Canteen

Upload Address Book

A CSV file consisting of directory numbers and display text with the semi-colon character (;) as delimiter may be uploaded.

- Click **Choose File** to upload a CSV file

Address Book Entries

- Fill in the **Number** and **Name** for each entry and click **ADD**

Up to 50 entries may be added.

5.6 OLED Labels

- ① *Note that only Turbine Compact stations configured with OLED Labels (TCIS-4, TCIS-5) under Main Settings will have this menu option.*

- Select **Advanced ICX-AlphaCom > OLED Labels**

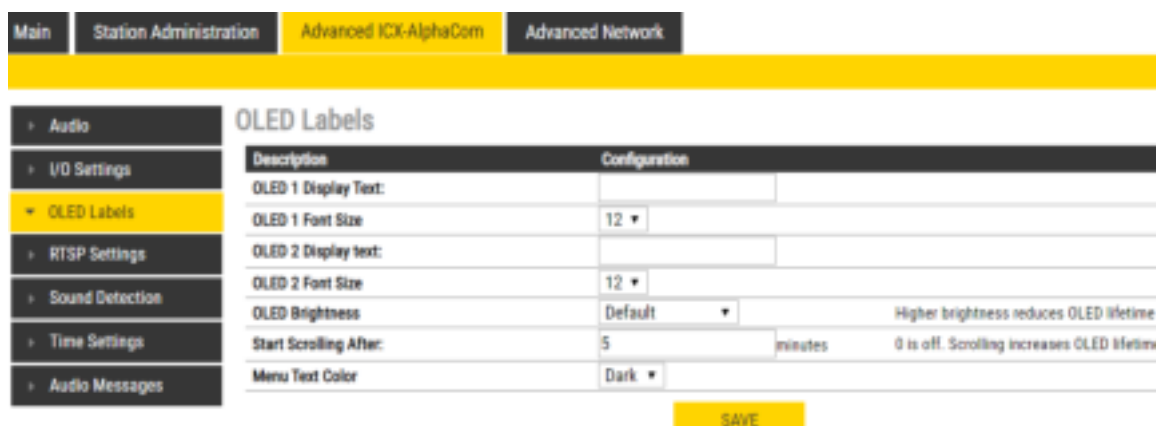

Main Station Administration **Advanced ICX-AlphaCom** Advanced Network

Audio
VO Settings
OLED Labels
RTSP Settings
Sound Detection
Time Settings
Audio Messages

OLED Labels

Description	Configuration
OLED 1 Display Text:	
OLED 1 Font Size	12 ▾
OLED 2 Display text:	
OLED 2 Font Size	12 ▾
OLED Brightness	Default ▾ Higher brightness reduces OLED lifetime
Start Scrolling After:	5 minutes 0 is off. Scrolling increases OLED lifetime
Menu Text Color	Dark ▾

SAVE

OLED Display Text

- Enter display text in the relevant fields for OLED 1 and OLED 2.

OLED Font Size

- The font size can be either **12** or **16**

OLED Brightness

- Select Brightness levels: **Extra Dim, Dim, Default, Bright, Extra Bright, Max Brightness**

Start Scrolling After

- Set the time in minutes, after which horizontal scrolling of the display text should start.

Menu Text Color

- The text color can be either **Dark** or **Light**

5.7 Sound Detection

- Select **Advanced ICX-AlphaCom > Sound Detection** from the menu

The screenshot shows the 'Sound Detection Settings' page. The navigation bar includes 'Main', 'Station Administration', 'Advanced ICX-AlphaCom', and 'Advanced Network'. The left sidebar lists settings categories: Audio, DAVC Settings, Offline Relays, I/O Settings, Keyboard Settings, Sound Detection (highlighted), RTSP Settings, and Time Settings. The main content area is titled 'Sound Detection Settings' and contains a table with the following data:

Description	Configuration
Sound Detection status:	DISABLED
Minimum amplitude (dBA):	57
Minimum duration of audio (ms):	100
DAK key to activate:	5
Minimum time before reactivation (ms):	2000
Report DAK key off after (ms):	3000

A 'SAVE' button is located at the bottom right of the settings table.

Sound Detection Settings

Here you can set the minimum amplitude and duration of the audio, the DAK to activate, etc.

5.8 Time Settings

- Select **Advanced ICX-AlphaCom > Time Settings** from the menu

The screenshot shows the 'Time Settings' page. The navigation bar includes 'Main', 'Station Administration', 'Advanced ICX-AlphaCom', and 'Advanced Network'. The left sidebar lists settings categories: Audio, DAVC Settings, Offline Relays, I/O Settings, Keyboard Settings, Sound Detection, RTSP Settings, and Time Settings (highlighted). The main content area is titled 'Time Settings' and contains a table with the following data:

Description	Configuration
Enable Network Time Protocol:	off
NTP server:	pool.ntp.org
Select Region:	Europe
Select Zone:	London
Enter Manual Date & Time:	2015/01/01 00:00:00

A 'SAVE' button is located at the bottom right of the settings table. Below the table, there is a note: "Note: It may take a couple of minutes before the NTP client updates time at startup or after hostname change."

Time Settings

You can enable Network Time Protocol, and select the region and time zone. You can also enter the date and time manually.

6 IC-EDGE Configuration

IC-EDGE is an IP-based intercom system for up to 32 intercom stations, expandable to 64 stations. The IC-EDGE system is easy to install and configure via a standard web browser.

For more information on IC-EDGE configuration, see wiki.zenitel.com/wiki/Category:IC-EDGE_Configuration.

One of the stations must be set as the **Edge Controller**. The Edge Controller acts as a server for the other intercom stations in the system. Any Turbine device can serve as an Edge Controller.

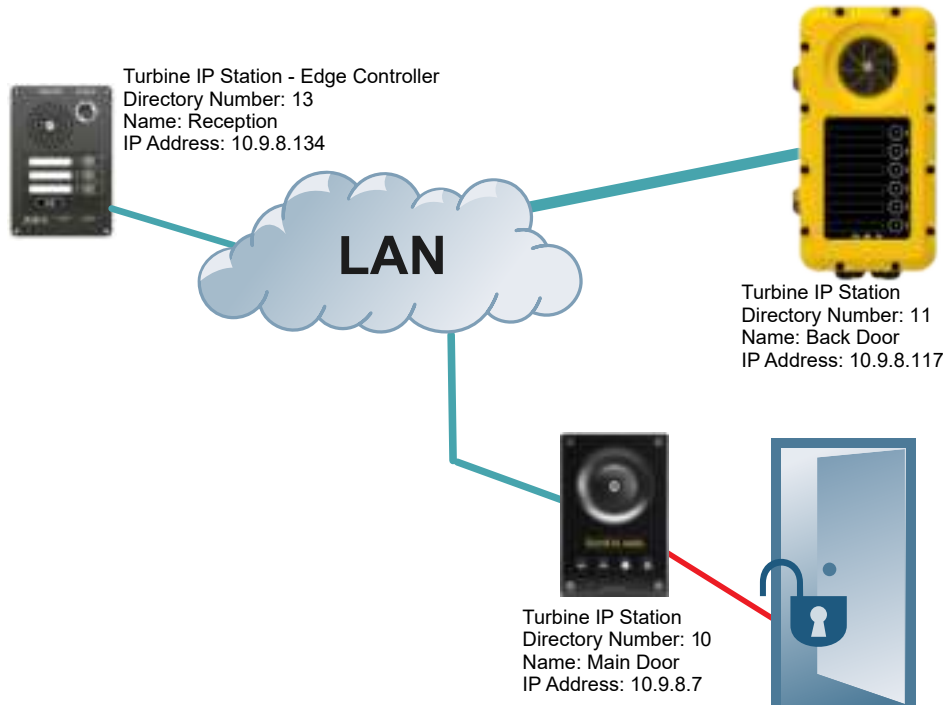

Figure 15 IC-EDGE System

6.1 Logging into the Station

Ensure that the IP address of your PC is in the same range as that of the station IP address. Access the station by logging into the web interface using a standard web browser on your PC:

1. Open a web browser
2. In the browser's address bar, type the station IP address and press the ENTER key
 - The station login page will be displayed.

To log into the station:



1. Click **Login**
2. Enter the default User name: **admin**
3. Enter the default Password: **alphaadmin**

The **Station Information** page will now be displayed, showing the IP station configuration and status.



Note that the user interface and parameters displayed in the following sections are dependent on the Turbine station type (Compact, Industrial or Ex) selected.

6.2 Main Settings

- Select **Main > Main Settings** to access the page for configuring station mode and IP parameters.

The screenshot shows the configuration interface for an Edge Controller. The 'Mode' section has radio buttons for 'TCI AlphaCom', 'Edge', 'GP', 'Edge', and 'Edge Controller', with 'Edge Controller' selected. The 'Product Model and Accessory' section has a dropdown menu for 'Model' with 'Mini (TMIS-1, TMIS-2)' selected. The 'IP Settings' section has a dropdown for 'Static IP' selected. Below this is a table for IP configuration:

IP Address:	10	0	0	124
Subnet Mask:	255	255	255	0
Gateway:	10	0	0	1
BMS Server 1:	0	0	0	0
BMS Server 2:	0	0	0	0

There are also checkboxes for 'Restore to Factory default settings', 'Read IP Address', and 'Ethernet Speed 10 Mb/s'. A 'Save' button is located at the bottom of the page.

Mode

- Select the **Edge Controller** radio-button
- ① **Edge Controller must be selected to be able to carry out the configurations described in the following sections.**

Product Model and Accessory

The options presented will depend on the Turbine model (Compact, Industrial or Ex).

- Select one of the options from the Model drop-down box:

Model: (for Compact)

- Kit (TKIS-2)
- Normal (TCIS-1, TCIS-2, TCIS-3)
- OLED Labels (TCIS-4, TCIS-5)
- Scrolling Station (TCIS-6)
- Mini (TMIS-1, TMIS-2)

Model: (for Extended)

- TKIE-1 (Kit)
- TFIE-1
- TFIE-2
- TFIE-6
- ECPIR-3P

Model: (for Ex)

- TFIX-1
- TFIX-2
- TFIX-3
- TFIX-4

Accessory: (for Extended & Ex)

- Handset
- Handset w/ Offhook

- Handset w/ Offhook (Normally Closed)
- Handheld Microphone
- Headset
- Headset w/ Autodetect

IP Settings

- **DHCP** – DO NOT select this option for the Edge Controller.
- **Static IP** – The Edge Controller should always use a Static IP Address. Enter values for:
 - **IP-address**
 - **Subnet-mask**
 - **Gateway**
 - **DNS Server 1** (option for network administration)
 - **DNS Server 2** (option for network administration)
 - **Hostname** (option for network administration)

Disable Reset to Factory default settings using frontboard and I/O

- Check the box to disable factory reset using frontboard and I/O.

Read IP Address

- **Read IP Address** enables an unregistered station to speak the IP address when the call button is pressed. **Read IP Address** box is checked, i.e. enabled, by default.

Enable RSTP (for Industrial & Ex)

- Check the **Enable RSTP** box to enable RSTP. RSTP is only required when using redundant networking.
- Click **SAVE** followed by **APPLY**

6.3 Connect other Intercom Stations

- Connect all other IP intercom stations to the network.
 - Note that all other IP intercom stations have to be on the same LAN (IP subnet) as the Edge Controller for them to be auto-discovered by the Edge Controller. Stations on a different subnet have to be manually added under **Manually Added Devices**

Wait for the stations to boot up (approximately 60 seconds) before proceeding to the next step.

6.4 Configure Edge Controller Directory

Log into the Edge Controller station with the new IP address that you have just set under **Station Main > Main Settings**. After login, you will find a new **Edge Controller** tab.

- Select **Edge Controller > System Configuration > Directory**

The **Edge Controller station will auto-discover all the other stations** on the LAN.

To identify the individual stations on the LAN:

- Click **Play Tone**
 - You should now hear a tone from the station you selected

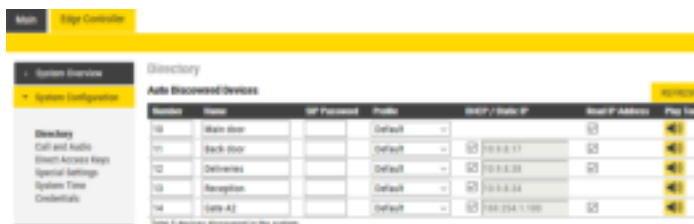

Name	IP Protocol	Profile	SIP / Audio IP	SIP Address	Play Tone
10 Main Door		Default		10.1.1.10	▶
11 Back Door		Default	10.1.1.11	10.1.1.11	▶
12 Detectors		Default	10.1.1.12	10.1.1.12	▶
13 Reception		Default	10.1.1.13	10.1.1.13	▶
14 Gate A2		Default	10.1.1.14	10.1.1.14	▶

You can now set **Numbers, Names, IP addresses, Profiles**, etc. for all the stations in the network. In our example, the Edge Controller is designated as *Reception* with directory number 13 while the two substations are the *Main Door* and *Back Door* with directory numbers 10 and 11 respectively.

- Click **SAVE**
 - The Edge Controller will now push the directory settings to all the IP intercom stations.

The devices should now have the status **Registered**.

- ① **SIP Password is an optional field you can set to increase the security level. The password is used by other intercom stations to register with the Edge Controller.**

6.5 Verify System Setup

To verify that the devices are successfully registered to the Edge Controller:

- Select **Edge Controller > System Overview**

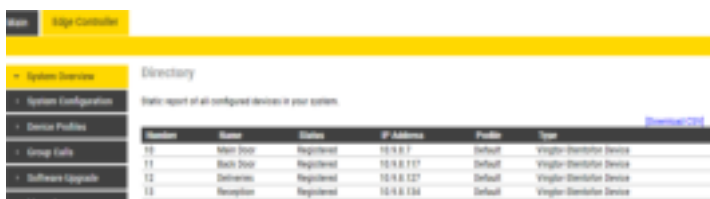

The screenshot shows the 'System Overview' page with a table of devices. The table has columns for Station, Name, Status, IP Address, Profile, and Type. All devices listed are in a 'Registered' status.

Station	Name	Status	IP Address	Profile	Type
10	Station 10	Registered	10.10.10.1	Default	Wiggle Standalone Device
11	Station 11	Registered	10.10.10.2	Default	Wiggle Standalone Device
12	Station 12	Registered	10.10.10.3	Default	Wiggle Standalone Device
13	Station 13	Registered	10.10.10.4	Default	Wiggle Standalone Device

All stations that have been configured should be displayed in the table. Stations that are up and running will have the status **Registered**.

6.6 Configure Call and Audio Settings

It is optional to configure the call and audio settings. Default settings will be used if they are not configured.

- Select **Edge Controller > System Configuration > Call and Audio**



The screenshot shows the 'Call and Audio' configuration page. It contains a table with columns for Station, Name, Auto Answer, Speaker Volume, Volume Override Level, ANC, AGC, AVC, and Accessory. The 'Call and Audio' menu item is highlighted in the left sidebar.

Station	Name	Auto Answer	Speaker Volume	Volume Override Level	ANC	AGC	AVC	Accessory
10	Station 10	Off	5	5	Off	Off	Off	
11	Station 11	Off	5	5	Off	Off	Off	
12	Station 12	Off	5	5	Off	Off	Off	
13	Station 13	Off	5	5	Off	Off	Off	

The **Call and Audio** menu include the following parameters:

Auto Answer

When not enabled, incoming calls will ring (Private mode) and has to be accepted by the user. When enabled, the call will connect straight through (Open mode). Auto Answer is typically enabled for substations and not for master stations.

Speaker Volume

This parameter sets the speaker volume for the station.

Volume Override Level

This sets the loudspeaker volume during volume override. Volume Override is used by Group Calls with Emergency priority.

ANC

Active Noise Cancellation: When enabled, most of the background noise will be filtered out of the microphone signal.

AGC

Automatic Gain Control: When enabled, the microphone signal will automatically be amplified when speaking with a low voice or if you are far away from the station.

AVC

Automatic Volume Control: When enabled, the loudspeaker volume is adjusted according to the ambient noise level. AVC will perform better if the **Speaker Volume** is set to a fairly low level, as this will give AVC a more dynamic range for adjustments. Note that AVC adjustment is disabled while the speaker is playing audio. Adjustments are made in silent periods (min. 100 ms silence required).

Accessory

If the station model supports accessories (headset, handset, etc.), you can choose the type of accessory here.

6.7 Modify IC-EDGE Device Profiles

The Station Profile defines a set of service features and parameters that are available for a group of devices.

The IC-EDGE system can have five device profiles:

- Profile 1 - Default
- Profile 2 - Substation
- Profile 3 - Display station

- Profile 4 - Operator
- Profile 5 - Gateway

The following service features and parameters are included in the device profile:

- Outgoing Call restriction
- Relay Activation (i.e. Door opening)
- Group Call initiation
- Busy Override

To modify device profiles:

- Select **Edge Controller > Device Profiles**

Description	Configuration
Profile nickname	Default
Outgoing calls allowed	<input checked="" type="checkbox"/> Default <input checked="" type="checkbox"/> Substation <input checked="" type="checkbox"/> Display station <input checked="" type="checkbox"/> Operator
Relay activation allowed	<input checked="" type="checkbox"/> Default <input type="checkbox"/> Substation <input type="checkbox"/> Display station <input type="checkbox"/> Operator
Group calls allowed	<input checked="" type="checkbox"/> All call <input checked="" type="checkbox"/> Conf <input checked="" type="checkbox"/> Group call 2 <input checked="" type="checkbox"/> Group call 3
Busy override allowed	<input type="checkbox"/>

The following parameters can be set for the station profile:

Profile nickname

The name of the profile. Any text can be used.

Outgoing calls allowed

Stations with this profile can call stations with the checked profiles. **Forbidden** will be displayed on the station if this is denied.

Relay activation allowed

Stations with this profile can activate the relay (e.g. Door Opening) on stations with the checked profiles.

Group calls allowed

Stations with this profile are allowed to dispatch the checked group calls

Busy override allowed

When calling a busy station, stations with this profile can force a connection by pressing 5.

6.8 Group Call

The IC-EDGE system supports 4 Group Calls.

A Group Call is activated by dialing the appropriate code (e.g. 84). A ding-dong chime will be heard on all member stations. Press the M-key to speak, and C-key to disconnect. Alternatively, Group Call can be used in handsfree mode, i.e. no need for pressing the M-key. Stations without any M-key will use handsfree mode by default. Group Call can be answered from any station by dialing the **answer code 99**.

Group Call audio can be sent and received by all Vingtor-Stentofon IP stations and can be sent from most modern SIP IP phones. Group Call audio can be received by SIP IP phones that have support for IP Multicast paging.

Operation

A Group Call is activated by dialing the appropriate code (e.g. 84). A ding-dong chime is heard in all member stations.

- Press the M-key to speak.
- Press the C-key to disconnect.

Default Group Call Settings

The factory default settings for group calls are as follows:

Nickname (Display Text)	Directory Number	Priority	Group Members	Chime	Answer
All Call	84	EMERGENCY	All Stations	Ding Dong	Yes
Group Call 1	85	HIGH	None	Ding Dong	Yes
Group Call 2	86	NORMAL	None	Ding Dong	Yes
Group Call 3	87	LOW	None	Ding Dong	Yes

When adding a new station to an existing IC-EDGE system, the station will automatically become a member of the All Call group.

Configuration of Group Calls

The Group Call properties are configured via the Edge Controller.

- Select **Edge Controller > Group Calls**

The screenshot shows the configuration page for 'Group Call 1 - All call' in the Edge Controller. The interface includes a sidebar with navigation options: System Overview, System Configuration, Device Profiles, Group Calls (selected), Software Upgrade, and Licensing. The main configuration area has a table with the following fields:

Description	Configuration
Nickname	All call
Number	84
Answer Group Call	<input checked="" type="checkbox"/>
Answer Timeout	30
Priority	EMERGENCY ▼
Chime	dingdong.wav ▼
Add all devices	<input type="checkbox"/>
Devices in group	<input checked="" type="checkbox"/> 101 TCIS-2 <input checked="" type="checkbox"/> 103 TCIV-6 <input checked="" type="checkbox"/> 104 TMIS-1 <input checked="" type="checkbox"/> 105 IP DeskMaster
Group Audio Address	239.195.40.54:61950

A yellow 'SAVE' button is located at the bottom right of the configuration area.

Change the parameters for each group as required:

Nickname

This is the display text shown in the initiating station when the group call is activated. Can be any text.

Number

The number to dial to activate the group call. If changed, a reboot of the Edge Controller is required for the changes to take effect.

Answer Group Call

Enable Group call answer by pressing “99” and setting the **Answer Timeout**. Default timeout value is 30 seconds to answer after the Group Call has been terminated. Timeout value of 0 means answering is only possible during the Group Call.

Priority

Priorities can be set for one Group Call at a time. A Group Call with higher priority will override a lower priority Group Call.

EMERGENCY: Volume and handset override. The Group Call audio is mixed with conversation audio

HIGH: The Group Call audio is mixed with conversation audio

NORMAL: The Group Call audio is not played if there is an ongoing conversation

LOW: The Group Call audio is not played if there is an ongoing conversation

Chime

Enables the playing of a ding-dong chime when a device receives a Group Call.

Devices in group

Select the devices that should receive Group Call audio. You can select all devices in one operation by checking the **Add all devices** box.

Group Audio Address

Multicast IP address and port used to send audio during Group Call. This information can be used to set up a IC-EDGE Group Call (multicast page) on 3rd-party SIP stations.

There is a **SAVE** button for each Group Call.

- Remember to click **SAVE** before you make changes to the next Group Call.

6.9 Mobile App Configuration

The Zenitel Mobile App is a mobile application for Android and IOS devices. The Mobile App enables the use of a mobile device as an intercom station in the IC-EDGE system.

6.9.1 Add the Mobile App to the Edge Controller

You need to manually add the Mobile App to the Edge Controller. When you add the Mobile App, it will automatically be assigned a number and name,

- Select **Edge Controller > System Configuration > Directory**

The screenshot displays the 'Directory' configuration page in the Edge Controller interface. It features a sidebar on the left with navigation options: System Overview, System Configuration (selected), Device Profiles, Group Calls, Software Upgrade, and Licensing. The main content area is titled 'Directory' and is divided into three sections: 'Auto Discovered Devices', 'Manually Added Devices', and 'Linked Edge Controllers'. The 'Auto Discovered Devices' section shows a table with 4 devices, including 'Main Door', 'Reception', 'Back Door', and 'Deliveries'. The 'Manually Added Devices' section shows a table with 1 device, 'Mobile'. A dropdown menu is open next to the 'Manually Added Devices' table, showing options: Vingtrol-Steretofon Device, Vingtrol-Steretofon Client, Zenitel Mobile (highlighted with a red box), 3rd party SIP, and Gateway. A yellow 'SAVE' button is visible at the bottom of the page.

- Under **Manually Added Devices** select **Zenitel Mobile** from the dropdown list
- Modify **Number** and **Name** as required (a default Number and Name will be inserted which you can modify)
- SIP Password** must be added (used as authentication during the registration process)
- Click **SAVE** to store the settings of the Mobile App in the Edge Controller.

6.9.2 Global Address List

A global list of addresses can be created in the address book of the MobileApp.

- Select **Edge Controller > System Configuration > Mobile App**

To autogenerate a global address list comprising all registered devices and all groups:

- Click **AUTO-GENERATE**

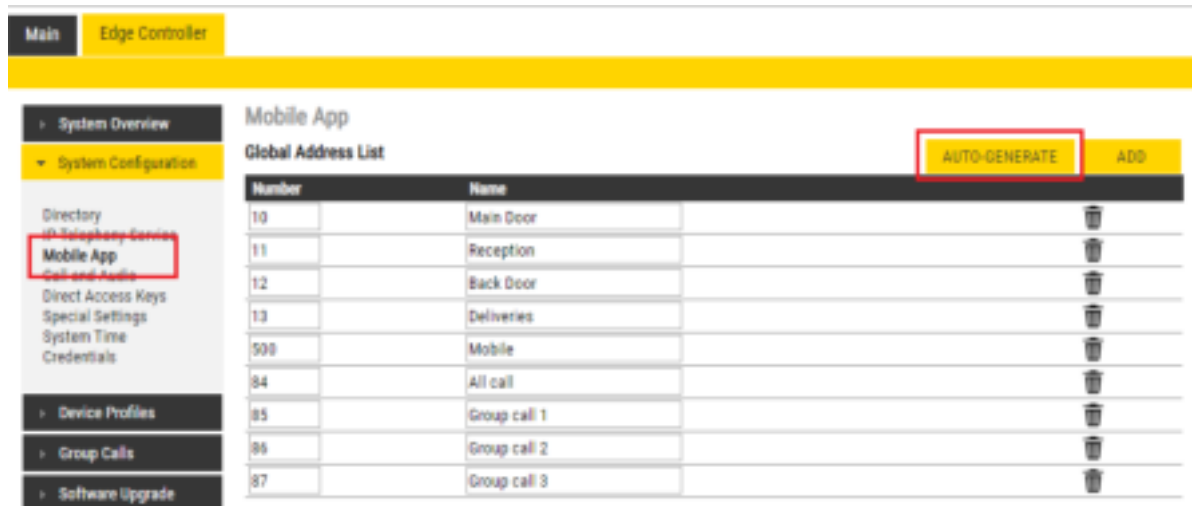

The screenshot shows the 'Mobile App' configuration page. The 'Global Address List' section is active, displaying a table with columns for 'Number' and 'Name'. The 'AUTO-GENERATE' button is highlighted with a red box. The 'ADD' button is also visible.

Number	Name	
10	Main Door	
11	Reception	
12	Back Door	
13	Deliveries	
500	Mobile	
84	All call	
85	Group call 1	
86	Group call 2	
87	Group call 3	

To manually add addresses:

- Click **ADD**

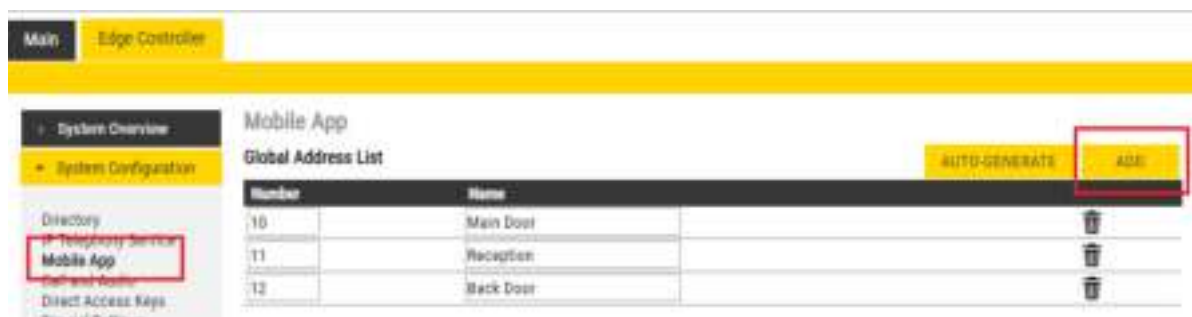

The screenshot shows the 'Mobile App' configuration page. The 'Global Address List' section is active, displaying a table with columns for 'Number' and 'Name'. The 'ADD' button is highlighted with a red box. The 'AUTO-GENERATE' button is also visible.

Number	Name	
10	Main Door	
11	Reception	
12	Back Door	

6.9.3 Action Buttons

There are three action buttons that enable the user to transfer calls, operate relays, or send DTMF during calls on the Mobile App.

To configure the action buttons:

- Select **Edge Controller > System Configuration > Mobile App**

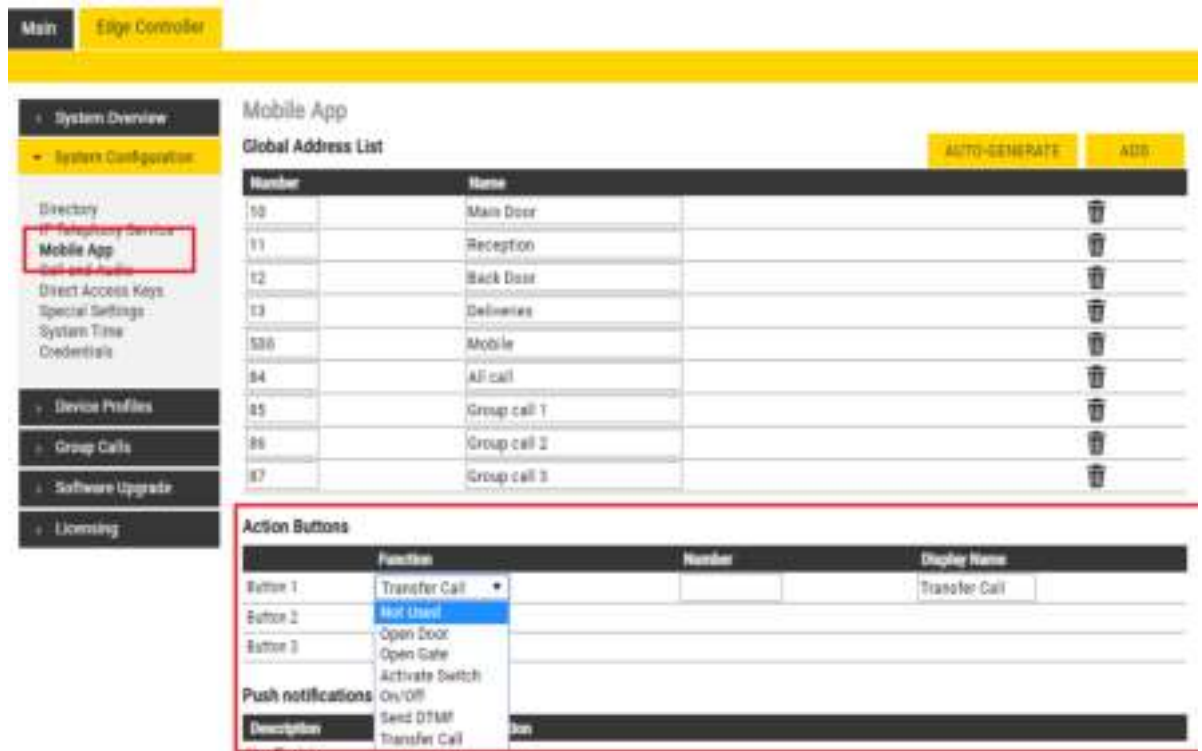

Under **Action Buttons**:

- Select the **Function** for each action button from the dropdown list
- Enter the **Number** and **Display Name** for each button
- Click **SAVE**

There are 6 functions for the action buttons:

- Open Door - activates the relay
- Open Gate - activates the relay
- Activate Switch - activates the relay
- On/Off - activates the relay
- Send DTMF - sends the DTMF that is selected
- Transfer Call - transfers calls to a predefined number or to a manually selected number in the Mobile App

6.10 Configure 3rd-party SIP Devices

Up to 10 3rd-party SIP devices such as SIP phones, SIP Speakers, Soft Phones can be registered to an IC-EDGE System. Each SIP device requires that a SIP User account is defined on the Edge Controller.

6.10.1 Install License

Before adding a 3rd-party SIP account to the IC-EDGE system, you need to obtain a license key. For each SIP device used in the system, there must be a valid SIP license installed.

To install a license:

- Select **Edge Controller > Licensing**

The screenshot shows the 'Licensing (Key Version 5)' page. A table lists license types: Intercom Extensions (0), SIP Client Extensions (4), and Softphone (0). The 'SIP Client Extensions' row is highlighted. Below the table, the 'License Key' section shows a 'New License' field with the placeholder 'Enter license key' and an 'ACTIVATE LICENSE' button.

- Enter the license key in the **New License** field and click **ACTIVATE LICENSE**

The **Licensing** table should now show all the licenses that are available.

6.10.2 Create SIP Account

- Select **Edge Controller > System Configuration > Directory**

The screenshot shows the 'Directory' page. It features two tables: 'Auto Discovered Devices' and 'Manually Added Devices'. The 'Manually Added Devices' table has a dropdown menu for 'Type' with '3rd party SIP' selected. A red box highlights this selection. Below the tables, there is a 'Linked Edge Controllers' section.

- Under **Manually Added Devices** select **3rd party SIP** from the dropdown list
- Modify **Number** and **Name** as required (a default Number and Name will be inserted which you can modify)
- Optionally one can add a **SIP Password**. If a password is entered, one has to also manually set the same password in the SIP device it self.
- Click **SAVE** to store the settings of the new SIP device in the Edge Controller.

6.10.3 Configure SIP Phone

You now have to log into the 3rd-party SIP phone to configure the SIP account to register it with the Edge Controller station. The Directory Number and Password (SIP Account) created in the previous section is used to register the 3rd-party station with the Edge Controller.

6.10.4 Verify Operation

On the Edge Controller device:

- Select **Edge Controller > System Overview**



The screenshot shows the 'Directory' page in the Edge Controller web interface. The page title is 'Directory' and it includes a subtitle 'Static report of all configured devices in your system.' and a 'Download CSV' link. A table lists various devices with columns for 'Extension', 'Name', 'Status', 'IP Address', 'Profile', and 'Type'. The row for 'SIP Device' is highlighted with a red box, showing its status as 'Registered'.

Extension	Name	Status	IP Address	Profile	Type
00	Main Desk	Registered	10.0.0.7	Default	Wingtip-Extension Device
01	Back Desk	Registered	10.0.0.107	Default	Wingtip-Extension Device
02	Deliveries	Registered	10.0.0.130	Default	Wingtip-Extension Device
03	Reception	Registered	10.0.0.134	Default	Wingtip-Extension Device
04	MR 400	Registered	10.0.0.147	Default	Wingtip-Extension Device
300	SIP Device	Registered	10.0.181.105	Default	3rd Party SIP Terminal

- Check that the SIP Device has gotten the **Status = Registered**

Verify that you can call to and from the SIP Device.

6.11 Advanced Configuration Mode

Settings for Direct Access Keys, Scripts, etc. described in the following sections are only available in Advanced Configuration Mode.

To enter Advanced Configuration Mode:

- Select **Main > Recovery**



The screenshot shows the 'Commands' page in the Edge Controller web interface. The 'Recovery' menu item is highlighted in the left sidebar. The main content area shows a table of commands and their actions, and a 'Preferences' section below it. The 'Advanced configuration mode' preference is visible, with a text input field for the offline password.

Description	Action
Full reboot	REBOOT
Partial reboot	REBOOT
Factory reset	FACTORY RESET
Factory reset with DHCP	FACTORY RESET

Description	Configuration
Advanced configuration mode	Type offline password to unlock advanced configuration mode

Under **Preferences**:

- Enter the offline password **1851** in the **Advanced configuration mode** field

Main Edge Controller

Information
Main Settings
Recovery
Help

Commands

Description	Action
Full reboot	REBOOT
Partial reboot	REBOOT
Factory reset	FACTORY RESET
Factory reset with DHCP	FACTORY RESET

Preferences

Description	Configuration
Advanced configuration mode	<input checked="" type="checkbox"/>

SAVE

- Check the **Configuration** box
- Click **SAVE**

Main Edge Controller

Information
Main Settings
Recovery
Help

Advanced configuration mode activated. Reload page to continue.

RELOAD

- Click **RELOAD**

A new tab called **Edge Configuration** will now appear:

Main Edge Configuration Station Administration Edge Controller Advanced Network

Account / Call
Audio
Direct Access Keys
Relays / Outputs
Time
I/D
Frontboard Mapping
RTP
Script
Script Events
Script Upload
Audio Messages
Multicast Paging
Certificates

Account Settings

Description	Configuration
Name:	TCTB-2
Number (SP ID):	101
Server Domain (SP):	10.9.3.105
Backup Domain (SP):	
Backup Domain 2 (SP):	
Authentication User Name:	101
Authentication Password:	
Register Interval:	600 (min: 60 seconds)
Register Failure Interval:	60 (min: 5 seconds)

Call Settings

Description	Configuration
Enable Auto Answer:	<input checked="" type="checkbox"/>
Auto Answer Delay:	0 seconds. Max 30 seconds.
Press and Hold Time:	0 seconds. Max 60 seconds. Defines how long a DAX key/input must be pressed before the call is established.

6.12 Direct Access Key & Ringlist Settings

There are two ways of configuring DAKs, Inputs and Ring List functions.

1. Via the Edge Controller whereby all stations in the system can be configured:
 - Select **Edge Controller > System Configuration > Direct Access Keys**
2. Via each individual station as describe below:
 - Select **Edge Configuration > Direct Access Keys**

Account Settings					
	Function	Idle	Call	No Ringlist	Normal
Button 1		Call To	Do Nothing	No Ringlist	Normal
Input 1		Call To	Do Nothing	No Ringlist	
Input 2		Call To	Do Nothing	No Ringlist	
Input 3		Call To	Do Nothing	No Ringlist	
Input 4		Call To	Do Nothing	No Ringlist	
Input 5		Call To	Do Nothing	No Ringlist	
Input 6		Call To	Do Nothing	No Ringlist	

SAVE

- ① **Note that the availability of these parameters and the number of keys depend on the Turbine station type selected under Main Settings.**

DAKs and Inputs have two states:

Idle: There is no active call on the station.

Call: There is an incoming, outgoing or active call on the station.

Idle

In Idle state the following options are available (available options will depend on the station type):

Call To: Enter the directory number to call when the DAK/Input is pressed. Extended call options (parallel ringing, call escalation, etc.) are available if the call is routed via the Ringlist.

Forward Call: Forward calls to the configured destination. Forwarding will be toggled On/Off every time the DAK key is pressed. Forwarding status is shown on DAK keys LEDs (ECPIR panel). Red LED indicates that Forwarding is turned on. The Forwarding function is not available on INCA stations, Substations and Kits.

Group Call: Enter the directory number of the Group Call to call when the DAK/Input is pressed. Two modes of operation are available:

- **Open (No M-key):** When the DAK key is activated, the microphone is open, and the user can talk handsfree
- **PTT (M-key):** When the DAK key is activated, the user must activate the microphone by pressing and holding the M-key (PTT key)

Conversation Mode: The station will toggle between Simplex mode (PTT - Press To Talk) and duplex mode (handsfree) every time the DAK is pressed. The selected mode is permanently stored. This function works in idle as well as during a call.

Volume Control: Change speaker volume by 1 point (+/- 4 dB). This function works in idle as well as during a call. There are two options:

- **Down:** decrease speaker volume by 1 point
- **Up:** increase speaker volume by 1 point

Call

During an active Call the following options are available (available options depend on station type):

Do Nothing: No action executed if the DAK/Input is activated during a call (Default)

Answer/End Call: Answers an incoming call, and ends an active call. Action can be executed either **On Key Press** or **On Key Release**. Has an option to also **Answer Group Call**.

End Call: Ends an active call. Action can be executed either **On Key Press** or **On Key Release**

Answer Call: Answers an incoming call. Has an option to also **Answer Group Call**.

Transfer Call: The “Transfer Call” function can work in two modes:

- Transfer immediately on key press when destination call number is configured
- Select transfer destination manually. When a destination call number is not configured, a key press will set the station in “Transfer Mode”, waiting for the user to dial the transfer destination, or to transfer to a predefined destination by pressing a key with “Call” action.

The active call is immediately hung-up if the transfer has progressed. If transfer fails (e.g. destination not found), the transfer will be aborted.

Park Call: Places a call on hold into a specific parking location (a fictional number) such that the call can then be picked up by another number.

Hold Call: When a “Call” button is configured to do “Hold Call” during the call, the button has different functionalities depending on the current state:

Incoming Call: Accept call

Established call: Put call on hold (disable audio)

On hold: Resumes a call (enable audio)

Send DTMF: Sends configured DTMF for key press and key release.

Send Text: Sends configured text for key press and key release. Enter text in the text field.

Push To Talk: Configure key to behave like a PTT key during active call.

Standby: Standby will reduce the volume of local speaker by a selected dB value, for the duration of the call or until pressed again.

Defer: Enables you to save the details of a call as it has been logged or updated, and to put off any action until a later stage.

Depending on the type of station and configured accessories, DAK Settings may also show additional options:

- Module keys 1 n (e.g. ECPIR-3P expansion module buttons)
- PTT / M-key
- Offhook
- Onhook

6.12.1 Ringlist Settings

- Log on to the web interface of the station that will be making the call to configure the ringlist of the stations that should be called.

To configure a ringlist:

- Select **Edge Configuration > Direct Access Keys**

There are variants of ringlists that can be set such as ringing time intervals, loopback, and ringing together with previous stations.

- ① **Note that some telephone gateways accept a call immediately on incoming calls – even before the call has been accepted by the user (telephone). This terminates the ringlist sequence and any subsequent numbers in the ringlist will never be called. This is solved by placing the gateway number at the end of the ringlist and disabling the “With Previous” option. Ringlists that include an auto-accepting gateway will never loop back.**

6.12.1.1 Forward Unattended Call

Main | **Edge Configuration** | Station Administration | Edge Controller | Advanced Network

Account / Call | Audio | **Direct Access Keys** | Relays / Outputs | Time | USB | Frontboard Mapping | RTPP | Script | Script Events | Script Upload | Audio Messages | Multicast Paging | Certificates

Account Settings

Function	Idle	Call To	Filter	Ringlist	Normal
Button 1	Idle	Call To	10	Ringlist 1	Normal
	Call	Answer Call	Filter: Do. No.		<input type="checkbox"/> Answer Group Call
Input 1	Idle	Call To		No Ringlist	
	Call	Do Nothing			
Input 2	Idle	Call To		No Ringlist	
	Call	Do Nothing			
Input 3	Idle	Call To		No Ringlist	
	Call	Do Nothing			
Input 4	Idle	Call To		No Ringlist	
	Call	Do Nothing			
Input 5	Idle	Call To		No Ringlist	
	Call	Do Nothing			
Input 6	Idle	Call To		No Ringlist	
	Call	Do Nothing			

SAVE

Ringlist Settings

	Ringlist 1	With Previous	Ringlist 2	With Previous	Ringlist 3	With Previous
Value 1	10	<input type="checkbox"/>		<input type="checkbox"/>		<input type="checkbox"/>
Value 2	11	<input type="checkbox"/>		<input type="checkbox"/>		<input type="checkbox"/>
Value 3	12	<input type="checkbox"/>		<input type="checkbox"/>		<input type="checkbox"/>
Value 4		<input type="checkbox"/>		<input type="checkbox"/>		<input type="checkbox"/>

Lower Ringlist (stops the ringlist)

Ringling Time: 10 (seconds), (S+unlimited)

Max Conversation Time: 0 (seconds), (S+unlimited)

SAVE

The above example ringlist setting may be illustrated as follows:

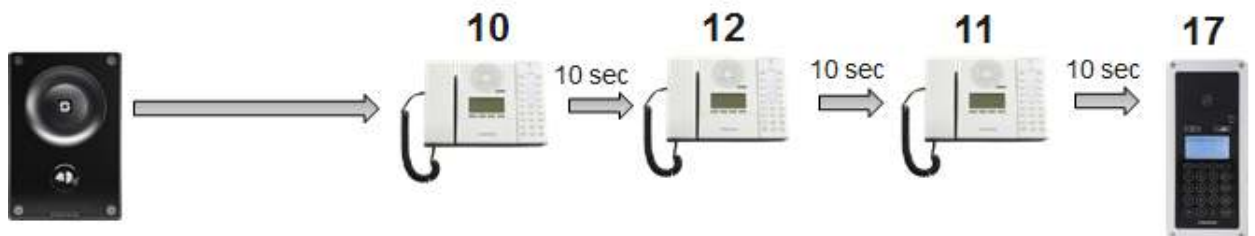

Via the Ringlist, an unattended call can be forwarded to another station after a preset time. The call forwarding can include several stations.

In the example, when the call button is pressed, the call goes to station number 10. If not answered within 10 seconds, the call will be forwarded to station number 12. If not answered, the call will be routed to 11, and finally to station number 17.

6.12.1.2 Forward Unattended Call with Loopback

Main **Edge Configuration** Station Administration Edge Controller Advanced Network

Account / Call
Audio
Direct Access Keys
Relays / Outputs
Time
I/D
Frontboard Mapping
RTSP
Script
Script Events
Script Upload
Audio Messages
Multicast Paging
Certificates

Account Settings

Function	Idle	Call	Ringlist	Normal
Button 1	Call To 10	Answer Call	Ringlist 1	Normal
Input 1	Call To	Do Nothing	No Ringlist	
Input 2	Call To	Do Nothing	No Ringlist	
Input 3	Call To	Do Nothing	No Ringlist	
Input 4	Call To	Do Nothing	No Ringlist	
Input 5	Call To	Do Nothing	No Ringlist	
Input 6	Call To	Do Nothing	No Ringlist	

SAVE

Ringlist Settings

	Ringlist 1	With Previous	Ringlist 2	With Previous	Ringlist 3	With Previous
Value 1	12	<input type="checkbox"/>		<input type="checkbox"/>		<input type="checkbox"/>
Value 2	11	<input type="checkbox"/>		<input type="checkbox"/>		<input type="checkbox"/>
Value 3	17	<input type="checkbox"/>		<input type="checkbox"/>		<input type="checkbox"/>

Loop Ringlist (loops the ringlist)

Max Loop Number 3 (3 = loop until answered)

Ringling Time 12 seconds (0=unlimited)

Max Conversation Time 0 seconds (0=unlimited)

SAVE

The above example ringlist settings may be illustrated as follows:

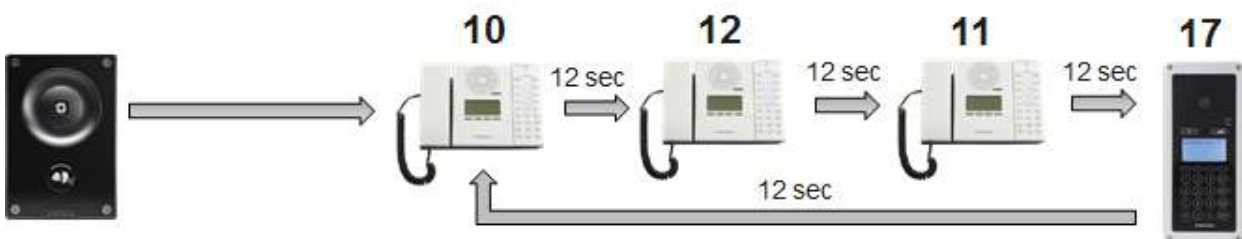

Via the Ringlist, an unattended call can be go through a call loop a preset number of times.

In the example, when the call button is pressed, the call goes to station number 10. If not answered within 12 seconds, the call will be forwarded to station number 12. If not answered, the call will be routed to 11, and finally to station number 17. Now the call is looped back to station number 10, repeating the same call pattern 3 times.

6.12.1.3 Parallel Ringing - Forward Call if Unattended

Main | **Edge Configuration** | Station Administration | Edge Controller | Advanced Network

Account Settings

Function				
Button 1	Idle: Call To	10	Ringlist 1	Normal
	Call: Answer Call	Filter Dir. No.		<input type="checkbox"/> Answer Group Call
Input 1	Idle: Call To		No Ringlist	
	Call: Do Nothing			
Input 2	Idle: Call To		No Ringlist	
	Call: Do Nothing			
Input 3	Idle: Call To		No Ringlist	
	Call: Do Nothing			
Input 4	Idle: Call To		No Ringlist	
	Call: Do Nothing			
Input 5	Idle: Call To		No Ringlist	
	Call: Do Nothing			
Input 6	Idle: Call To		No Ringlist	
	Call: Do Nothing			

SAVE

Ringlist Settings

	Ringlist 1	With Previous	Ringlist 2	With Previous	Ringlist 3	With Previous
Value 1	12	<input checked="" type="checkbox"/>		<input type="checkbox"/>		<input type="checkbox"/>
Value 2	11	<input type="checkbox"/>		<input type="checkbox"/>		<input type="checkbox"/>
Value 3	17	<input checked="" type="checkbox"/>		<input type="checkbox"/>		<input type="checkbox"/>

Loop Ringlist (loops the ringlist)

Ringling Time 15 seconds, (0=unlimited)

Max Conversation Time 0 seconds, (0=unlimited)

SAVE

The above example ringlist setting may be illustrated as follows:

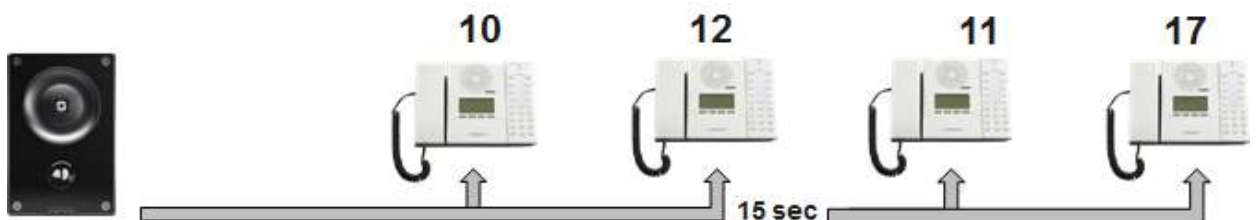

By checking the **With Previous** box in the Ringlist, one can call several stations in parallel. When one of the stations answers, it will stop ringing in the other(s).

In the example, when the call button is pressed, the call goes to station number 10 and 12 in parallel. If not answered within 15 seconds, the call will be forwarded to stations number 11 and 17.

6.13 Script Settings

Script (Virtual I/O) is a feature for activating scripts on station events.

These scripts can be uploaded and configured via the menu options:

- Script Upload
- Script
- Script Events

The Turbine station should be operating in **Edge** mode.

6.13.1 Script Upload

- Select **Edge Configuration > Script Upload**

The screenshot shows the 'Script Upload' page in the configuration interface. At the top, there are navigation tabs: 'Main', 'Edge Configuration' (highlighted), 'Station Administration', and 'Advanced Network'. On the left, a sidebar menu lists various configuration options, with 'Script Upload' highlighted. The main content area is titled 'Scripts' and contains a table with one entry: 'Script 1' with the label 'activateOutput.lua' and a 'DELETE' button. Below the table is an 'Upload Script' section with a 'Choose File' button and the text 'No file chosen'. An 'UPLOAD' button is located at the bottom right of the upload section.

Upload Script

- Click **Choose File** to select the desired script
- Click **UPLOAD** to upload the desired script

6.13.2 Script Configuration

- Select **Edge Configuration > Script**

The screenshot shows the 'Script Configuration' page in the configuration interface. At the top, there are navigation tabs: 'Main', 'Edge Configuration' (highlighted), 'Station Administration', and 'Advanced Network'. On the left, a sidebar menu lists various configuration options, with 'Script' highlighted. The main content area is titled 'Digital Outputs - Scripts' and contains a 'Choose script slot to configure:' dropdown menu with 'Slot 1' selected. Below this is an 'Assign a Label' field with the text 'Activate Output'. Underneath is an 'Enter script in selected slot' field with the text 'lua activateOutput.lua admin alphaedelin gpio1 00.9.7.10'. A 'SAVE' button is located at the bottom right of the configuration section.

Digital Outputs - Scripts

- Select the script **Slot 1 - Slot 10** to configure
- Assign a logical name to the script in the **Assign a Label** field
- Enter the script to activate and add parameters in the text field under the **Enter script in selected slot** field

6.13.3 Script Events

- Select **Edge Configuration > Script Events**

Event	Digit	Activate Output	Duration
Remote Digit (DTMF)	Digit 1	Activate Output	after a duration of
Incoming Call			after a duration of
Outgoing Call			after a duration of
Incoming Ringing			after a duration of
Outgoing Ringing			after a duration of
Idle			after a duration of
Error (Not Registered)			after a duration of
Input 1 Pressed			after a duration of
Input 1 Released			after a duration of
Input 2 Pressed			after a duration of
Input 2 Released			after a duration of
Input 3 Pressed			after a duration of
Input 3 Released			after a duration of
Input 4 Pressed			after a duration of

Digital Outputs - Events

- Set the **Digit** for the **Event** to **Execute**

6.14 Audio Messaging

Prerecorded audio messages can be uploaded to a Turbine which can be triggered by various events occurring on the station. The audio message playback can be triggered by 3 main events: DTMF, Call, Relay.

There are two ways of configuring audio messages.

1. Via the Edge Controller whereby all stations in the system can be configured:
 - Select **Edge Controller > System Configuration > Special Settings**
2. Via each individual station as describe below:
 - Select **Edge Configuration > Audio Messages**

6.14.1 Uploading Audio Files

- Select **Edge Configuration > Audio Messages**

Name	Event	Option
1 UnattendedBaggage_en_30_3.wav	Unused	

Space used: 0.504 mb of 20 mb

Upload Media

Choose File No file chosen

UPLOAD

Message Settings

Choose Message	Event	Option
Choose Message	Unused	
Choose Message	Unused	
Choose Message	Unused	

Under **Upload Media**:

- Click **Choose File** to browse to the desired audio file
- Click **UPLOAD**

The file will now appear in the list of audio files under **Media**.

After the upload, the amount of space left of the maximum of 20 MB is displayed.

It is possible to delete audio files to free up more space by clicking **Delete**.

6.14.2 Play Message on DTMF Event

An audio message can be played on receiving DTMF tones during a call. Valid digits are **DTMF 0 - 9, *, #**. The event can be filtered by directory number (SIP ID).

Choose Message	Event	Option
RingTone.wav	DTMF	DTMF 3 Dir. No / SIP ID
		Speaker
Choose Message	Unused	

In the configuration example above, the audio file “ringcd.wav” will be played when the station receives DTMF 3 during a call (i.e. the other party in the conversation presses digit 3 on his keypad).

Note that the call must be established before the DTMF digit is sent, otherwise the message will not be triggered. The message will be played once, and mixed with the conversation audio.

6.14.3 Play Message On Call Event

An audio message can be played on **Incoming/Outgoing, Incoming, Outgoing** call direction. It can in addition be filtered by directory number (SIP ID). The following call events are supported:

Call Ringing: Incoming/Outgoing call on the station (no auto-answer)

Call Queued: Outgoing call from the station has been queued on the master station

Call Accepted: Incoming/Outgoing call on the station has been accepted/answered

Group Accepted: Outgoing Group Call from the station has been established

Call Ended: Incoming/Outgoing call on the station has been ended/hung-up/cancelled

On Hold: A call from the station has been put on hold by remote master station

Transferred: A call from the station has been transferred by remote master station to a third station, and the station is ringing (no auto-answer). “Your call has been transferred, please wait...” message will be played on the station. The event will not be triggered on the master station that initiated the transfer.

You can choose whether the message should be played once, or be repeated until the Call Event is ended:

One Time: The audio message will be played once.

Repeat: The message will be repeated with a time interval set in **Pause** until the call event is ended.

File Then Tone: The audio message will be played once, followed by the standard ringing tone.

The example below shows a setting where a reassurance message (e.g. “Your call has been registered, please wait”) will be played to the caller while waiting for the receiving station to answer:

Message Settings

Choose Message	Event	Option
RingTone.wav	Call	Call Ringing Outgoing Dir. No / SIP ID Speaker File Then Tone
Choose Message	Unused	

The audio message will be played once, followed by the standard ringing tone.

6.14.4 Play Message on Relay Event

An audio message can be played when a Relay or an Output changes state. Available states are: **On, Off, Slow Blink, Fast Blink.**

The example below shows a setting where a message (e.g. “The door is open, please enter”) will be played when the relay of the door station is operated:

Play a message when the relay at the door station is operated

Message Settings

Choose Message	Event	Option
Door Open.wav	Relay	Relay 1 On Speaker
Choose Message	Unused	

The audio message will be played once and mixed with the conversation audio.

6.14.5 Routing of Audio Message

The audio message can be routed to: **Speaker** or **Speaker & Mic**

The audio message is always routed to the loudspeaker of the station, but there is an option to send the audio message as a “Microphone” signal as well. This means that the audio message can be transmitted to the other party during an established call. The “Speaker & Mic” option is feasible for the call events **Call Accepted** and **Group Accepted**. When “Speaker & Mic” option is selected, the microphone signal will be disabled while the message is playing. Once the message has stopped playing, the microphone will be enabled again.

The example below shows a setting where a when an elevator alarm is triggered, and the operator answers the call, the location of the alarm will be played as a voice message:

Message Settings

Choose Message	Event	Option
Elevator B5.wav	Call	Call Accepted Outgoing Dir. No / SIP ID Speaker & Mic One Time
Choose Message	Unused	

When the alarm call from the elevator intercom is answered, an audio message, e.g. “Alarm Call from Elevator B5”, is played in the elevator and to the receiver of the call.

7 SIP Configuration

SIP (Session Initiation Protocol) is the de facto standard for IP telephony. The Turbine SIP intercom stations are specially built for easy integration with any iPBX system.

For more information on SIP configuration, see wiki.zenitel.com/wiki/SIP_Intercom_Configuration

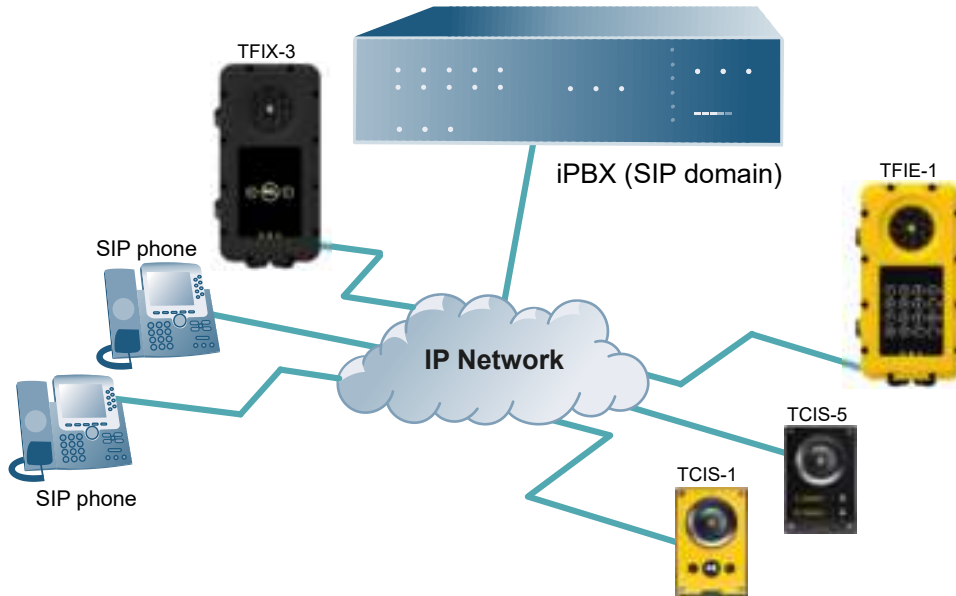

Figure 16 SIP System

The following sections describe configuration procedures using the web interface of the station.

7.1 Logging into the Station

Ensure that the IP address of your PC is in the same range as that of the station IP address. Access the station by logging into the web interface using a standard web browser on your PC:

1. Open a web browser
2. In the browser's address bar, type the station IP address and press the ENTER key
- The station login page will be displayed.

To log into the station:



1. Click **Login**
2. Enter the default User name: **admin**
3. Enter the default Password: **alphaadmin**

The **Station Information** page will now be displayed, showing the IP station configuration and status.



Note that the user interface and parameters displayed in the following sections are dependent on the Turbine station type (Compact, Industrial or Ex) selected.

7.2 Main Settings

- Click **Main > Main Settings**

The screenshot shows the 'Main Settings' configuration page. The 'Mode' section has a radio button for 'SIP'. The 'Product Model And Accessory' section has a dropdown menu for 'Model' with options like 'Normal (TKIS-1, TCIS-2, TCIS-3)'. The 'SIP Settings' section has a dropdown for 'Preferred Internal Protocol (SIP)' and a table for 'SIP Servers' with columns for IP Address, Port, and Priority. The 'IP Settings' section has a dropdown for 'Auto IP Method' and a table for 'IP Addresses' with columns for IP Address, Subnet Mask, Gateway, and DNS Server 1-2. A 'Save' button is located at the bottom right of the page.

Mode

- Select the **SIP** radio-button

Product Model And Accessory

The options presented will depend on the Turbine model (Compact, Industrial or Ex).

- Select one of the options from the Model drop-down box:

Model: (for Compact)

- Kit (TKIS-2)
- Normal (TCIS-1, TCIS-2, TCIS-3)
- OLED Labels (TCIS-4, TCIS-5)
- Scrolling Station (TCIS-6)
- Mini (TMIS-1, TMIS-2)

Model: (for Extended)

- Kit (TKIE-2)
- TFIE-1
- TFIE-2
- TFIE-6
- ECPIR-3P

Model: (for Ex)

- TFIX-1
- TFIX-2
- TFIX-3
- TFIX-4

Accessory: (for Extended & Ex)

- Handset
- Handset w/ Offhook
- Handset w/ Offhook (Normally Closed)
- Handheld Microphone
- Headset
- Headset w/ Autodetect

IP Settings

- **DHCP** – Select this option if the IP station shall receive IP Settings from a DHCP server.
- **Static IP** – Select this option if the IP station shall use a static IP address. Enter values for:
 - **IP-address**
 - **Subnet-mask**
 - **Gateway**
 - **DNS Server 1** (option for network administration)
 - **DNS Server 2** (option for network administration)
 - **Hostname** (option for network administration)

Disable Reset to Factory default settings using frontboard and I/O

- Check the box to disable factory reset using frontboard and I/O.

Read IP Address

- **Read IP Address** enables an unregistered station to speak the IP address when the call button is pressed. **Read IP Address** box is checked, i.e. enabled, by default.

Enable RSTP (for Industrial & Ex)

- Check the **Enable RSTP** box to enable RSTP. RSTP is only required when using redundant networking.
- Click **SAVE** followed by **APPLY**

7.3 Account/Call Settings

- Select **SIP Configuration > Account / Call**

The screenshot shows the 'SIP Configuration' web interface. The top navigation bar includes 'Main', 'SIP Configuration', and 'Station Administration'. The left sidebar has a menu with 'Account / Call' selected, along with 'Audio', 'Direct Access Keys', 'Relays / Outputs', 'Time', 'Audio Messages', and 'Certificates'. The main content area is titled 'Account Settings' and contains a table with the following data:

Description	Configuration
Name:	TCIS-2
Number (SIP ID):	101
Server Domain (SIP):	10.8.5.101
Backup Domain (SIP):	
Backup Domain 2 (SIP):	
Registration Method:	Parallel ▼
Authentication User Name:	101
Authentication Password:	
Register Interval:	600 (min. 60 seconds)
Register Failure Interval:	60 (min. 5 seconds)
Outbound Proxy (optional):	Port: 5060
Outbound Backup Proxy (optional):	Port: 5060
Outbound Backup Proxy 2 (optional):	Port: 5060
Outbound Transport:	UDP ▼
SIP Scheme:	sip ▼ Using sip forces all proxies to also use TLS
RTP Encryption:	disabled ▼
SRTCP Crypto Type:	AES_CM_128_HMAC_SHA1_80 ▼
Use Unencrypted SRTCP:	<input type="checkbox"/>
Verify TLS hostname:	<input type="checkbox"/>
TLS Private Key:	turbine_server_sha256.key ▼

Below the 'Account Settings' table is the 'Call Settings' section, which contains a single row:

Description	Configuration
Enable Auto Answer:	<input type="checkbox"/>

At the bottom of the page, there is a yellow 'SAVE' button.

Account Settings

Name

- Enter a name that will be shown on the display at the remote party.

Number (SIP ID)

- This is the identification of the station in the SIP domain, i.e. the phone number for the station. This parameter is mandatory. Enter the SIP ID in integers according to the SIP account on the SIP domain server.

Server Domain (SIP)

- This parameter is mandatory and specifies the primary domain for the station and is the IP address for the SIP server (e.g. Asterisk or Cisco Call Manager). Enter the IP address in regular dot notation, e.g. 10.6.201.10.

Backup Domain (SIP)

- This is the secondary (or fallback) domain. If the station loses connection to the primary SIP domain, it will switch over to the secondary one. Enter the IP address in regular dot notation.

Backup Domain 2 (SIP)

- This is the tertiary SIP domain used as backup in case the primary and secondary domains fail.

Registration Method

- **Parallel:** The station will register to the primary, secondary and tertiary SIP server domains at the same time.
- **Serial:** The station will always try to register to the first available SIP server domain, starting with the primary domain, followed by the secondary and the tertiary domains.
- **Top-Down:** This is the same as for Serial registration except that it will always revert to the SIP domains with the higher priority if available. In decreasing order of priority, the primary SIP domain has the highest priority, followed by the secondary domain and the tertiary domain.
- **Cisco:** This is for the Cisco environment only with Publisher/Subscriber/SRST setup, where the station is normally registered to Publisher. The Subscriber should be assigned as the secondary SIP domain, and SRST gateway as the tertiary domain.

Authentication User Name

- This is the authentication user name used to register the station to the SIP server. This is required only if the SIP server requires authentication and is normally the same as the SIP ID.

Authentication Password

- The authentication user password used to register the station to the SIP server. This is required only if the SIP server requires authentication

Register Interval

- This parameter specifies how often the station will register, and reregister in the SIP domain. This parameter will affect the time it takes to detect that a connection to a SIP domain is lost.
- Enter the values in number of seconds from 60 to 999999. The default interval is 600 seconds.

Outbound Proxy [optional]

- Enter the IP address of the outbound proxy server in regular dot notation, e.g. 10.5.2.100

Port

- Enter the port number used for SIP on the outbound proxy server. The default port number is 5060.

Outbound Backup Proxy 1&2 [optional]

- Enter the IP address of the backup outbound proxy server in regular dot notation, e.g. 10.5.2.100

Outbound Transport

Possible configuration options: **UDP**, **TCP**, **TLS**. For TCP and TLS options, it is necessary to set Outbound Proxy to have the same value as Server Domain.

SIP Scheme

Possible configuration options: **sip**, **sips**. Using sips forces all proxies to also use TLS.

RTP Encryption

Possible configuration options: **disabled**, **srtp_encryption**

SRTP Crypto Type

Possible configuration options: **AES_CM_128_HMAC_SHA1_80** / **AES_CM_128_HMAC_SHA1_32**

Use Unencrypted SRTCP

Check the box to enable unencrypted SRTCP

TLS Private Key

Possible configuration options: **turbine_server_sha256.key** / **turbine_server_sha1.key**

Call Settings

Enable Auto Answer

- If enabled, the station will answer automatically, and if not, the station will ring.

- After entering the desired values, click **SAVE** followed by **REBOOT** to enable the SIP settings.

7.4 Audio Settings

- Select **SIP Configuration > Audio**

Description	Configuration	
Speaker Volume:	2 ▾	
Volume Override Level:	8 ▾	Sets the volume during volume override. Volume and handset override happens during Emergency Group calls.
Automatic Gain Control (AGC):	<input type="checkbox"/>	Automatic Gain Control. If speech level and environmental noise are very unstable it may be turned on.
Automatic Volume Control (AVC):	<input type="checkbox"/>	Volume depends on noise level
Active Noise Cancellation (ANC):	<input checked="" type="checkbox"/>	

SAVE

Speaker Volume

- Set speaker volume between 0 and 5

Volume Override Level

- Select the volume override level in the range 0 to 8 from the drop-down menu

Automatic Gain Control (AGC)

- If speech level and environmental noise are very unstable, it may be enabled

Automatic Volume Control (AVC)

- When enabled volume control is adjusted according to the noise level. Disabled by default.

Active Noise Cancellation (ANC)

- When enabled, most of the background noise will be filtered out of the microphone signal. Enabled by default.

- After entering all the desired values, click **SAVE**

7.5 Direct Access Key & Ringlist Settings

To configure DAK keys, Inputs and Ring List functions:

- Select **SIP Configuration > Direct Access Keys**

The screenshot shows the 'SIP Configuration' web interface. The top navigation bar includes 'Main', 'SIP Configuration', and 'Station Administration'. A left sidebar contains a menu with 'Direct Access Keys' selected. The main content area is divided into two sections: 'Account Settings' and 'Ringlist Settings'.

Account Settings

Function	Id:	Call To	No Ringlist	Normal
Button 1	Id:	Call To	No Ringlist	Normal
	Call:	Do Nothing		
Input 1	Id:	Call To	No Ringlist	
	Call:	Do Nothing		
Input 2	Id:	Call To	No Ringlist	
	Call:	Do Nothing		
Input 3	Id:	Call To	No Ringlist	
	Call:	Do Nothing		
Input 4	Id:	Call To	No Ringlist	
	Call:	Do Nothing		
Input 5	Id:	Call To	No Ringlist	
	Call:	Do Nothing		
Input 6	Id:	Call To	No Ringlist	
	Call:	Do Nothing		

SAVE

Ringlist Settings

	Ringlist 1	With Previous	Ringlist 2	With Previous	Ringlist 3	With Previous
Value 1	102	<input type="checkbox"/>		<input type="checkbox"/>		<input type="checkbox"/>
Value 2	103	<input type="checkbox"/>		<input type="checkbox"/>		<input type="checkbox"/>
Value 3		<input type="checkbox"/>		<input type="checkbox"/>		<input type="checkbox"/>
Value 4		<input type="checkbox"/>		<input type="checkbox"/>		<input type="checkbox"/>
Value 5		<input type="checkbox"/>		<input type="checkbox"/>		<input type="checkbox"/>
Value 6		<input type="checkbox"/>		<input type="checkbox"/>		<input type="checkbox"/>
Value 7		<input type="checkbox"/>		<input type="checkbox"/>		<input type="checkbox"/>

SAVE

- ① **Note that the availability of these parameters and the number of keys depend on the Turbine station type selected under Main Settings.**

For more information on the configuration of DAK keys, Inputs and Ring List functions, see [wiki.zenitel.com/wiki/Direct_Access_Key_%26_Ringlist_Settings_\(SIP\)](http://wiki.zenitel.com/wiki/Direct_Access_Key_%26_Ringlist_Settings_(SIP))

7.6 Relay/Output Settings

- Select SIP Configuration > Relays / Outputs

Relay Settings

Choose Relay To Configure:

Relay 1 Settings

Description	Configuration
Remote Digit For Relay On:	- ▼
Remote Digit For Relay Off:	- ▼
Remote Digit For Relay Slow Flash :	- ▼
Remote Digit For Relay Fast Flash:	- ▼
Remote Digit For Relay Toggle:	- ▼
Remote Digit For Timed Relay On:	6 ▼
Timed Relay Duration:	3 seconds
Outgoing Ringing:	- ▼
Incoming Ringing:	- ▼
Outgoing Call:	- ▼
Incoming Call:	- ▼
Group Call (Edge mode only):	- ▼
Idle:	Off ▼
Error (Not Registered):	- ▼

SAVE

Relay Settings

- Select Relay 1, Relay 2, Relay 3 (Relay Board) or Relay 4 (Relay Board) from the drop-down box.

There are 4 different states: On, Off, Slow Flash, Fast Flash

- Select the remote digit (DTMF signal) under **Configuration**
 - Selecting “-” symbol means that the behaviour does not change when the event occurs. The relay state can change either with a remote digit (DTMF signal) during a call, or if the station state changes.

Remote Digit For Relay On / Off / Slow Flash / Fast Flash

- Select the digit (DTMF signal) that should change the relay to the On/Off/Slow Flash/Fast Flash state

Remote Digit For Relay Toggle

- Select the digit to toggle the relay on/off every time the specified DTMF digit is received

Remote Digit For Relay Timed Relay On

- Select the digit that should change the relay to the on state for a number of seconds set in **Timed Relay Duration**. This state is normally used for the Door Opening function.

Outgoing Ringing / Incoming Ringing

Operate the relay while the station is ringing due to an incoming or outgoing call. The ringing state occurs from the start of the call until the call is accepted.

Outgoing Call / Incoming Call

Operate the relay while the station is in conversation. The call state occurs from acceptance of the call until the call ends.

Group Call (IC-Edge mode only)

Operate the relay when the station receives a Group Call

Idle

Select the state the relay should change to when nothing else is occurring on the station.

Error (Not Registered)

Select the state the relay should change to when the station is off-line.

7.7 Time Settings

- Select **SIP Configuration > Time**

Description	Configuration
Enable Network Time Protocol:	<input checked="" type="checkbox"/>
NTP server:	pool.ntp.org
Select Region:	Europe
Select Zone:	London
Enter Manual Date & Time:	2015 01 01 00 00 yyyy-MM-dd hh-mm

Note: It may take a couple of minutes before the NTP client updates time at startup or after hostname change.

Time Settings

You can enable NTP (Network Time Protocol), select the time zone and enter the date and time manually.

7.8 Audio Messages

Prerecorded audio messages can be uploaded to a Turbine which can be triggered by various events occurring on the station. The audio message playback can be triggered by 3 main events: DTMF, Call, Relay.

- Select **SIP Configuration > Audio Messages**

Choose Message	Event	Option
Choose Message	Unused	
Choose Message	Unused	

Under **Upload Media**:

- Click **Choose File** to browse to the desired audio file
- Click **UPLOAD**

The file will now appear in the list of audio files under **Media**.

After the upload, the amount of space left of the maximum of 20 MB is displayed.

7.9 Advanced Configuration Mode

Settings for I/O, Scripts, etc. described in the following sections are only available in the Advanced Configuration Mode.

To enter Advanced Configuration Mode:

- Select **Main > Recovery**

The screenshot shows the 'Recovery' menu selected in the left sidebar. The main content area is divided into 'Commands' and 'Preferences' sections.

Description	Action
Full reboot	REBOOT
Partial reboot	REBOOT
Factory reset	FACTORY RESET
Factory reset with DHCP	FACTORY RESET

Description	Configuration
Advanced configuration mode	Type offline password to unlock advanced configuration mode

Under **Preferences**:

- Enter the offline password **1851** in the **Advanced configuration mode** field

The screenshot shows the 'Recovery' menu selected in the left sidebar. The main content area is divided into 'Commands' and 'Preferences' sections. The 'Advanced configuration mode' field now contains the password '1851' and a 'SAVE' button is visible.

Description	Action
Full reboot	REBOOT
Partial reboot	REBOOT
Factory reset	FACTORY RESET
Factory reset with DHCP	FACTORY RESET

Description	Configuration
Advanced configuration mode	1851

SAVE

- Check the **Configuration** box
- Click **SAVE**



- Click **RELOAD**

New menu items such as **I/O**, **Script** under **SIP Configuration** and a new tab called **Advanced SIP** will now appear:

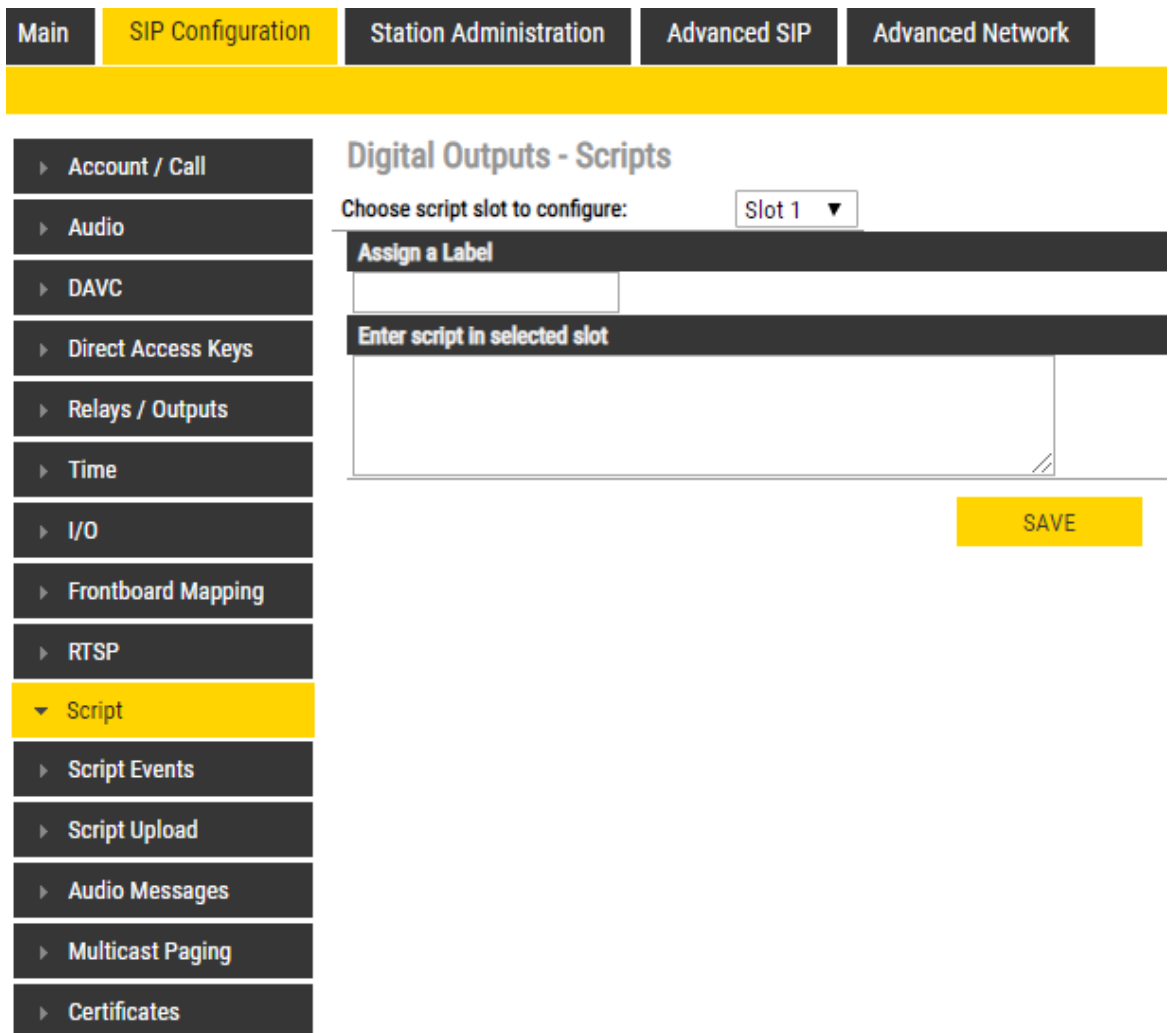

For more information on Script settings, see [wiki.zenitel.com/wiki/Virtual_I/O_\(SIP\)](http://wiki.zenitel.com/wiki/Virtual_I/O_(SIP))

7.10 I/O Settings

- Select **SIP Configuration > I/O**

Description	Configuration
Use Inputs As Key Matrix	Off
Fast Blink Pattern	111000111000111000111000 1 = on, 0 = off, 100 ms interval
Slow Blink Pattern	111111111111100000000000 1 = on, 0 = off, 100 ms interval
I/O Pin 1:	Input 1
I/O Pin 2:	Input 2
I/O Pin 3:	Input 3
I/O Pin 4:	Input 4
I/O Pin 5:	Input 5
I/O Pin 6:	Input 6

Use Inputs As Key Matrix

If there is a need for more than the 6 inputs available, it is possible to combine inputs as in a keyboard matrix, and in this way create more DAKs.

The options are:

- 2 Inputs (input 1-2, DAK 1-3)
- 3 Inputs (input 1-3, DAK 1-7)
- 4 Inputs (input 1-4, DAK 1-15)

Fast Blink Pattern

- Set the fast blink pattern for the LEDs

Slow Blink Pattern

- Set the slow blink pattern for the LEDs
- Select either Input or Output options from the drop-down box for I/O Pins 1 to 6

For further information, see [wiki.zenitel.com/wiki/I/O_Settings_\(SIP\)](http://wiki.zenitel.com/wiki/I/O_Settings_(SIP))

8 Common Advanced Network Settings

① The configuration settings described in this section are not mandatory.

Advanced Network settings are available in **ICX-AlphaCom**, **Edge Controller** and **SIP** mode.

8.1 SNMP Settings

SNMP (Simple Network Management Protocol) is a protocol for centralizing the management of devices in IP networks.

- Select **Advanced Network > SNMP**

SNMP Settings

Description	Configuration	Information
Access	Disabled	Access mode
SNMP v1	<input type="checkbox"/>	Enable SNMP v1
SNMP v2c	<input type="checkbox"/>	Enable SNMP v2c
Community string	public	For v1 and v2c only
Allowed Network	0.0.0.0 / 0	Example: 192.168.1.0/24
Name		
Location		
Contact		

SNMP Trap and Informs Settings

Description	Configuration	Information
Trap receiver		Disable Traps by setting this field empty
Informs receiver		Disable Informs by setting this field empty

SNMP Custom Configuration File

Upload New Custom snmp.conf File

File: g@enom... Ingen fi valgt

File name MUST be 'snmp.conf'

UPLOAD SNMP CONFIGURATION

Enable SNMP Traps

Description	Enabled	Information
IP Station Started	<input type="checkbox"/>	The device has started
Registration Successful	<input type="checkbox"/>	Device has successfully registered with a SIP server
Registration Failed	<input type="checkbox"/>	Device failed to register with a SIP server
Call Connected	<input type="checkbox"/>	Call has connected successfully
Call Connect Failed	<input type="checkbox"/>	Call has failed to connect
Call Disconnect	<input type="checkbox"/>	Call has disconnected
Dial Pressed	<input type="checkbox"/>	DAK was pressed. Trap description will provide more info about DAK number.
Dial Released	<input type="checkbox"/>	DAK was released. Trap description will provide more info about DAK number.
Relay Activated	<input type="checkbox"/>	Relay was activated. Trap description will provide more info about relay number.
Relay Deactivated	<input type="checkbox"/>	Relay was deactivated. Trap description will provide more info about relay number.
Button Hanging	<input type="checkbox"/>	Button was pushed for more than 10 seconds without being released
Sound Test Failed	<input type="checkbox"/>	Sound test failed
Sound Test Error	<input type="checkbox"/>	Automatically setting sound pressure level failed
Sound Test Success	<input type="checkbox"/>	Sound test was successful
Input Button Pressed	<input type="checkbox"/>	Input button was pressed. Trap description will provide more info about input number.
Input Button Released	<input type="checkbox"/>	Input button was released. Trap description will provide more info about input number.
Software Fault	<input type="checkbox"/>	Software daemon has stopped working. Trap description will provide more info about affected daemon.

SAVE ALL

SNMP Settings

Access

- Options are Read or Disable SNMP

Enable SNMP v1

- This enables reading of the MIB using SNMP version 1.

Enable SNMP v2c

- This enables reading of the MIB using SNMP version 2c.

Community string

- Enter a text string used as a password for authentication.

Allowed Network

- This is used, together with the network mask, to determine the allowed network for reading the MIB on the station.
- The IP address is entered in regular dot notation, e.g. 10.5.2.100. For example with an allowed network 10.5.2.0 and a network mask of 24, any station with an IP address in the range 10.5.2.0 to 10.5.2.255 can access the MIB.

Name

- SNMP name string (sent as sysName OID in traps)

Location

- SNMP Location string

Contact

- SNMP Contact string

SNMP Trap and Informs Settings

Trap receiver

- Enter the IP address of the server receiving SNMP traps. This is disabled if the field is left empty.

Inform receiver

- Enter the IP address of the server receiving SNMP informs. This is disabled if the field is left empty.

SNMP Custom Configuration File

- Upload the custom **snmpd.conf** file that will be used when running SNMP. The uploaded file will be preserved after the station has been upgraded to a newer firmware version.

Enable SNMP Traps

IP-Station Started

- If enabled, the station will send an SNMP trap when the station application is started.

Registration Successful

- If enabled, the station will send an SNMP trap when successfully registered in the SIP domain.

Registration Failed

- If enabled, the station will send an SNMP trap if registration in the SIP domain failed.

Call Connected

- If enabled, the station will send an SNMP trap when a call is connected.

Call Connect Failed

- If enabled, the station will send an SNMP trap if a call to the station fails to connect for any reason (busy etc.).

Call Disconnect

- If enabled, the station will send an SNMP trap when a call is disconnected.

Dak Pressed

- If enabled, the station will send an SNMP trap when a DAK is pressed.

Dak Released

- If enabled, the station will send an SNMP trap when a DAK is released.

Relay Activated

- If enabled, the station will send an SNMP trap when a relay is activated.

Relay Deactivated

- If enabled, the station will send an SNMP trap when a relay is deactivated.

Button Hanging

- If enabled, the station will send an SNMP trap when a button is hanging.

Sound Test Failed

- If enabled, the station will send an SNMP trap when a sound test has failed.

Sound Test Error

- If enabled, the station will send an SNMP trap when there is a sound test error.

Sound Test Success

- If enabled, the station will send an SNMP trap when a sound test is successful.

Input Button Pressed

- If enabled, the station will send an SNMP trap when an input is activated.

Input Button Released

- If enabled, the station will send an SNMP trap when an input is deactivated.

Software Fault

- If enabled, the station will send an SNMP trap when software daemon has stopped working.

8.2 Network Access Control

IEEE 802.1X is an IEEE Standard for Port-based Network Access Control (PNAC). It provides an authentication mechanism to devices wishing to attach to a LAN, either establishing a point-to-point connection or preventing it if authentication fails.

802.1X Network Access Control is configured from the IP station web interface.

- Select **Advanced Network > 802.1X**

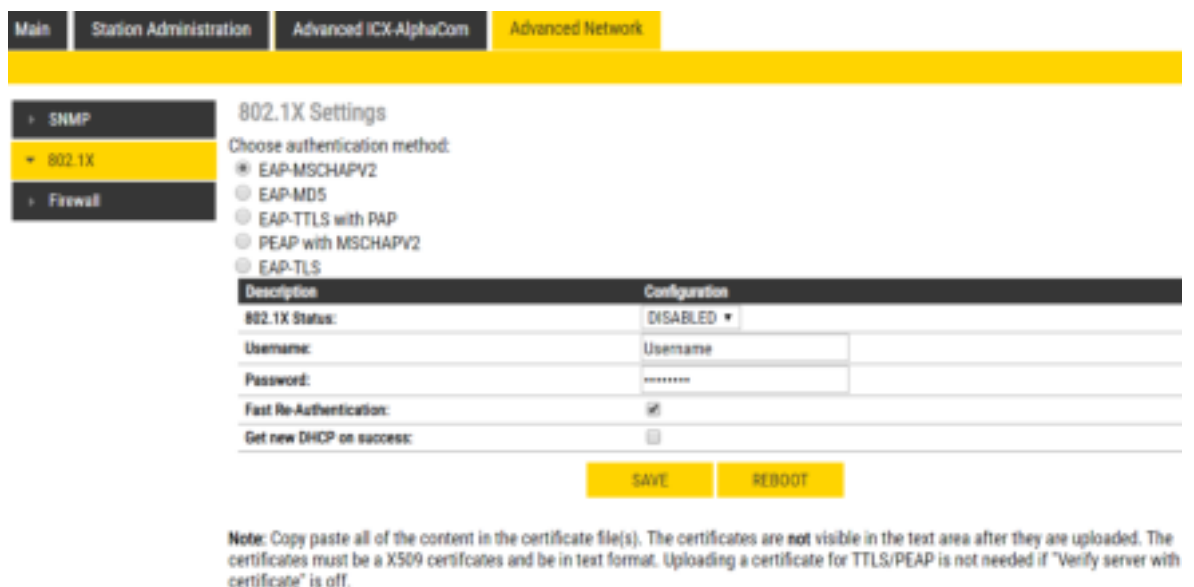

Description	Configuration
802.1X Status:	DISABLED ▼
Username:	Username
Password:	*****
Fast Re-Authentication:	<input checked="" type="checkbox"/>
Get new DHCP on success:	<input type="checkbox"/>

The radio-button list lets the user choose the authentication method to configure.

The different authentication methods are:

- EAP-MSCHAPV2
- EAP-MD5
- EAP-TTLS with PAP
- PEAP with MSCHAPV2
- EAP-TLS

EAP-MSCHAPV2 and **EAP-MD5** will encrypt the password.

EAP-TTLS with PAP and **PEAP with MSCHAPV2** will encrypt both the **Username** and **Password**.

The parameters to configure depend on the authentication method:

802.1X status: Enable or disable 802.1X.

Username: The user name that identifies a station.

Password: The password associated with the user name.

Fake username: The fake user name sent outside of the encrypted tunnel with **EAP-TTLS with PAP** and **PEAP with MSCHAPV2**. The user name is encrypted.

Verify server with certificate: [**EAP-TTLS with PAP**, **PEAP with MSCHAPV2** and **EAP-TLS** only] Specifies that the client verifies that server certificates presented to the client have the correct signatures, have not expired, and were issued by a trusted root certification authority (CA). It's enabled by default.

Fast Re-Authentication: Re-authenticates the clients connected to 802.1x-enabled interfaces.

Get new DHCP on success: If 802.1X authentication is successful, the station will restart its DHCP client.

Insert CA Certificate: [**EAP-TTLS with PAP**, **PEAP with MSCHAPV2** and **EAP-TLS** only] Uploads certificate (public key) used by authentication server. This is not required if the **Verify server with certificate** option is disabled.

Insert User Public Certificate: [**EAP-TLS** only] Uploads certificate (public key) used by authentication client (user).

Insert User Private Key: [**EAP-TLS** only] Uploads the private key that is paired with the user public certificate.

- Click **SAVE** to save the current settings
- Click **REBOOT**

The new 802.1X settings will only come into effect after the reboot.

8.3 Firewall Settings

- Select **Advanced Network > Firewall** from the menu

Name	Protocol	Port	Enabled
SSH	tcp	22	<input checked="" type="checkbox"/>
HTTP	tcp	80	<input checked="" type="checkbox"/>
HTTPS	tcp	443	<input checked="" type="checkbox"/>
SIP	tcp	5060	<input checked="" type="checkbox"/>
SIPS	tcp	5061	<input checked="" type="checkbox"/>
DIP	tcp	50001	<input checked="" type="checkbox"/>
Demo	tcp	50010	<input type="checkbox"/>
AudioData	udp	5035	<input type="checkbox"/>
TFTP Server	udp	88	<input checked="" type="checkbox"/>
SNMP	udp	161	<input checked="" type="checkbox"/>
SIP	udp	5060	<input checked="" type="checkbox"/>
Edge	udp	5062	<input checked="" type="checkbox"/>
mDNS	udp	5353	<input checked="" type="checkbox"/>
DIP Multicast	udp	50001	<input checked="" type="checkbox"/>
Discovery	udp	50002	<input checked="" type="checkbox"/>
ZAP	tcp	50004	<input checked="" type="checkbox"/>
ZapWeb	tcp	8080	<input type="checkbox"/>
VoIP	udp	61000 - 61250	<input checked="" type="checkbox"/>
RTSP	tcp	554	<input checked="" type="checkbox"/>

SSH: Enable or disable SSH on station, disabled by default.

HTTP: Enable or disable HTTP on station, enabled by default.

HTTPS: Enable or disable HTTPS on station, enabled by default.

SIP (tcp): Enable or disable SIP over tcp on station, enabled by default.

SIPS: Enable or disable SIPS on station, enabled by default.

DIP: Enable or disable DIP on station, enabled by default.

Demo: Enable or disable Demo on station, disabled by default.

AudioData: Enable or disable AudioData on station, disabled by default.

TFTP Server: Enable or disable TFTP Server on station, enabled by default.

SNMP: Enable or disable SNMP on station, enabled by default.

SIP (udp): Enable or disable SIP over udp on station, enabled by default.

Edge: Enable or disable IC-EDGE on station, enabled by default.

mDNS: Enable or disable mDNS on station, enabled by default.

DIP Multicast: Enable or disable DIP Multicast on station, enabled by default.

Discovery: Enable or disable Discovery on station, enabled by default.

Zap: Enable or disable ZAP on station, enabled by default.

ZapWeb: Enable or disable ZapWeb on station, enabled by default.

VoIP: Enable or disable VoIP on station, enabled by default.

RTSP: Enable or disable RTSP on station, enabled by default.

9 Station Software Upgrade

This sections describes the software upgrade procedure via the web interface of the station.

Other ways of upgrading the software on the IP station can be found on Zenitel Wiki:

- Uploading the software via AlphaWeb on the AlphaCom server
 - see wiki.zenitel.com/wiki/AlphaWeb#IP_Station_Upgrade
- Automatic Software Upgrade in SIP Mode
 - see wiki.zenitel.com/wiki/Automatic_Software_Upgrade
- Using the Vingtor-Stentofon Intercom Manager Tool (VS-IMT)
 - see wiki.zenitel.com/wiki/VS-IMT_Upgrade_Stations

① **Turbine Ex stations have a built-in Flowire component. Refer to A100K11958 FCDC3 Flowire Configuration Manual when upgrading software for Ex stations.**

9.1 Prerequisites

The upgrade methods require that an TFTP Server is available and that the latest software image files have been downloaded from Zenitel Wiki. During the upgrade process, the IP station will connect to the TFTP Server and download the software. Install the TFTP Server program on your PC.

9.2 Upgrade via Station Web Interface

This section pertains to upgrading from version 5.1.x.x to a newer version. For information on upgrading from earlier versions, see wiki.zenitel.com/wiki/Turbine_Software_Upgrade.

- Start the TFTP server program and click **Browse** to select the folder where the software image files are located

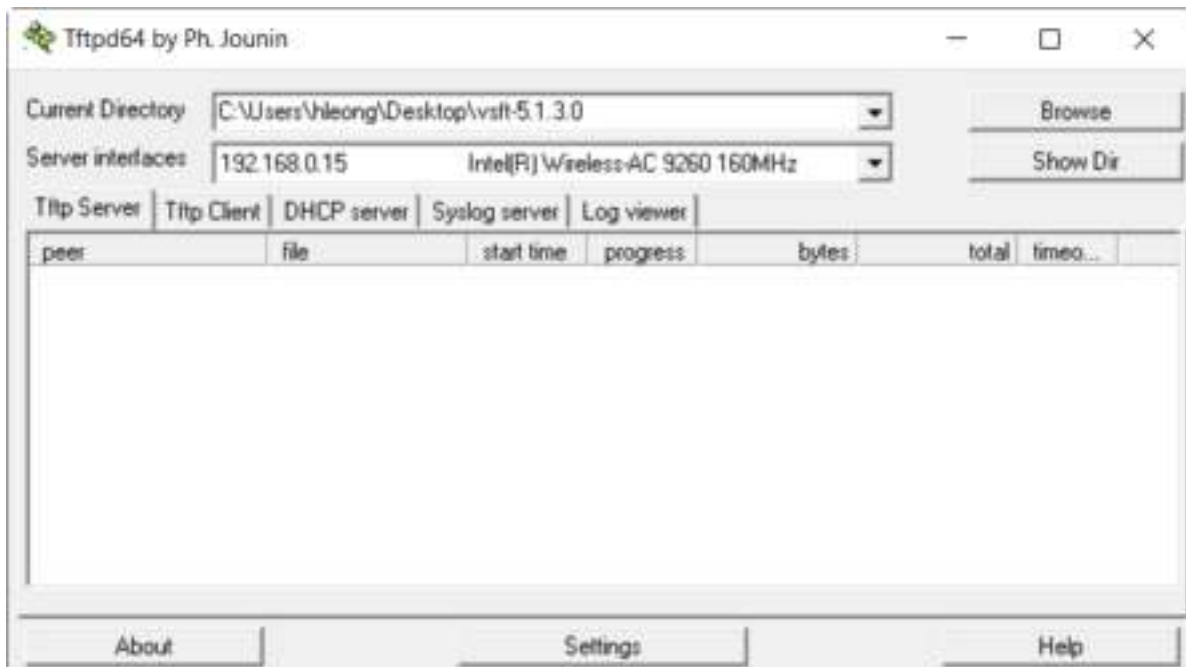

1. Log on to the IP Station web interface
2. Select **Station Administration > Manual Upgrade**

The screenshot shows the web interface for station administration. At the top, there are navigation tabs: 'Main', 'Station Administration' (highlighted in yellow), 'Advanced ICX-AlphaCom', and 'Advanced Network'. Below these, a left sidebar contains 'Manual Upgrade' (highlighted in yellow) and 'Change Password'. The main content area is titled 'Upgrade using TFTP (.zip images)'. It features two input fields: 'TFTP server:' with the value '192.168.0.15' and 'Image file:' with the value 'vsft-5.1.3.0'. A yellow 'Start Upgrade' button is positioned below the fields.

3. Enter the IP address of the **TFTP server** (your PC's IP address)
4. Enter the prefix (e.g. **vsft-5.1.x.x**) to the software image files in the **Image file** field
5. Click **Start Upgrade**

The station will now try to contact the TFTP server. The upgrade procedure takes about 3 minutes. The process can be monitored by clicking the **Log viewer** tab in the TFTP server program.

① *During an upgrade of the station, 802.1X will not be running. Thus if 802.1X reauthentication is enabled and is performed during the upgrade, the station may lose contact with the TFTP server (depending on the configuration when 802.1X authentication fails). If the station loses contact with the TFTP server, it will not be upgraded.*

10 Station Indication LEDs

10.1 LEDs on Front Plate

10.1.1 Compact Stations



Status LEDs

- **Bell icon** lights **yellow** when a call is placed and ringing
- **Talk icon** lights **green** when a call is active and in conversation
- **Door icon** lights **red** when the door is unlocked or relay is active



Talk Icon: Flashing at 1 second intervals

- Station has no connection to the AlphaCom server/exchange.

Possible reasons:

- No connection to Ethernet
- Wrong AlphaCom XE IP address configured
- Invalid IP address
- No gateway or wrong gateway to the AlphaCom server/exchange



Talk Icon: Flashing at 5 second intervals

- Station connected but NOT registered in the AlphaCom server/exchange.

Reason:

- Station has not been programmed in AlphaPro

10.1.2 ECPIR-3P, Industrial & Ex Stations

Power LED - Green

- Steady light: Power is OK

Fault LED - Yellow

- Steady light: Not used
- Flashing: Not registered/no connection to server

Call LED - Red

- Steady light: In a conversation/call

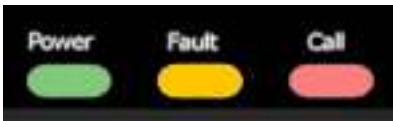

10.2 Status LEDs on PCB



Industrial

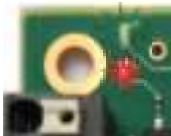

Compact

Flashing 2 red + 1 green

- Station has no connection to the AlphaCom server/exchange.

Flashing 1 red + 2 green

- Station connected but NOT registered in the AlphaCom server/exchange.

Flashing 3 green

- Station connected and registered in the AlphaCom server/exchange.

10.3 Ethernet Activity & Speed LEDs



Industrial



Compact

Green LED

- Steady light: Ethernet connection OK
- Flashing: Ethernet data traffic
- No light: No Ethernet connection

Yellow LED

- Steady light: 100 Mbit Ethernet connection
- No light: 10 Mbit Ethernet connection

11 Restoring Factory Defaults

A Turbine IP Station may have to be reset to its original factory default settings if, for instance, the password to the station web interface is forgotten. The defaults can either be set to Activated DHCP or Static IP.

11.1 Reset to Factory Default Settings with Activated DHCP

To reset:

1, 2, 3, 4, 5



1. While **pressing any button**, power up the station by connecting to a PoE switch.
2. Hold the button until the station audio starts counting, and release the button on **count 1**.
3. Press and hold the button on **count 5** and release on **count 0**.
- if there is no 0 count, the procedure has failed and you have to start again
4. Press the **call key**, **number keys** or **DAKs** to make the station speak its IP address.

Factory default values

Station IP address: (determined by DHCP server)

Username: **admin**

Password: **alphaadmin**

11.2 Reset to Factory Default Settings with Static IP

To reset:

1, 2, 3



1. While **pressing any button**, power up the station by connecting to a PoE switch.
2. Hold the button until the station audio starts counting, and release the button on **count 1**.
3. Press and hold the button on **count 3** and release on **count 0**.
- if there is no 0 count, the procedure has failed and you have to start again
4. Press the **call key**, **number keys** or **DAKs** to make the station speak its IP address.

Factory default values

Station IP address: **169.254.1.100**

Username: **admin**

Password: **alphaadmin**

A: Compact Board Connectors

A.1 PCB - Front

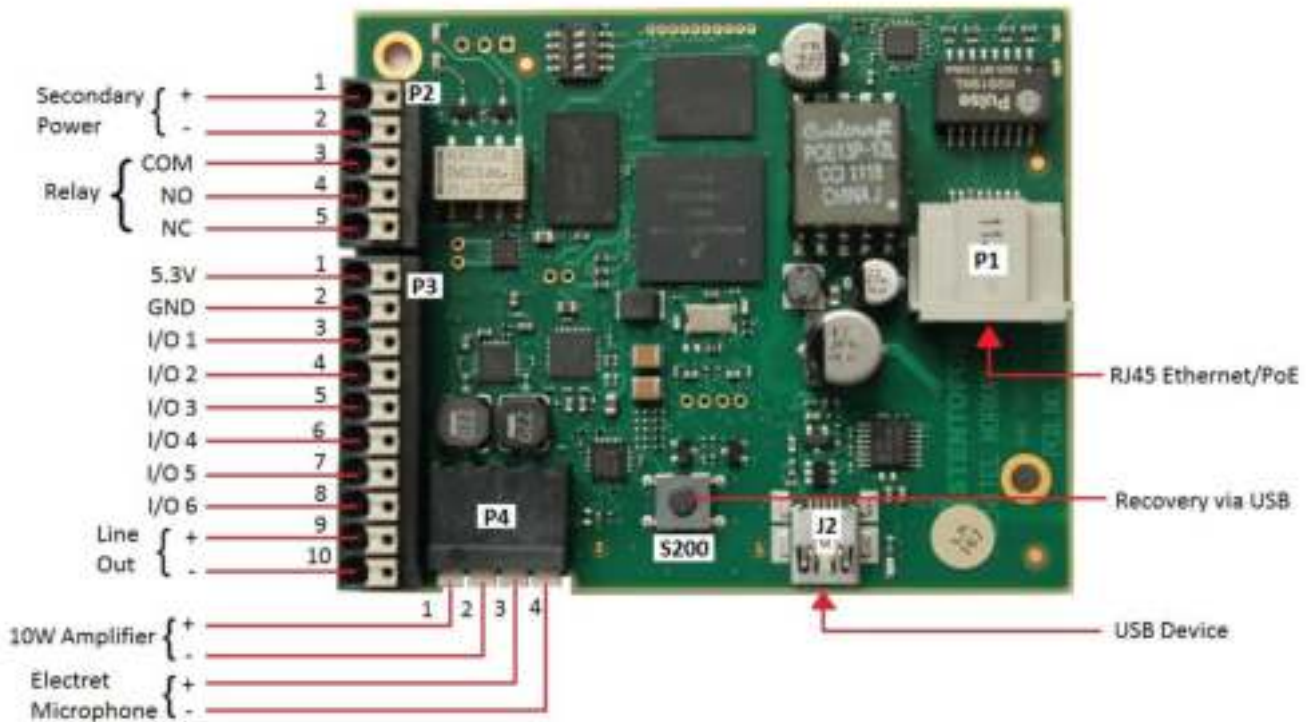

P1 RJ45 PoE port for 10/100 Mbit Ethernet connection. The station can be powered from this port if the line supports Power over Ethernet (PoE).

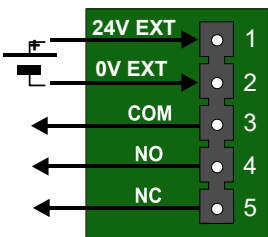

P2 5-pin plug-on terminal for external connections.
 Pin 1/2 24 VDC for external secondary power if PoE is not used. Pin 1 is positive.
 Pin 3 COM relay
 Pin 4 NO relay
 Pin 5 NC relay

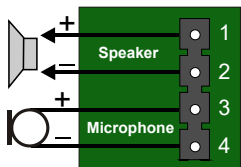

P4 Loudspeaker & Electret microphone
 Pin 1 10W Speaker amplifier +
 Pin 2 10W Speaker amplifier -
 Pin 3 Electret Microphone +
 Pin 4 Electret Microphone -

① To enable the electret microphone input when using a TKIS-2, the Frontboard must be set to Kit under Station Main Settings.

A.2 Input Connectors

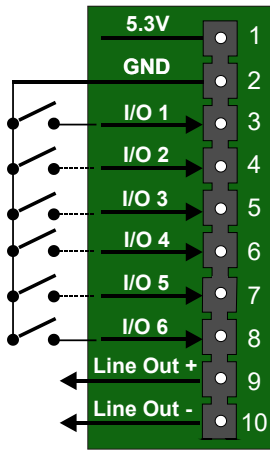

P3 10-pin plug-on terminal for external connections.

Pin 1 5.3V

Pin 2	GND
Pin 3	Button Input or LED Driver
Pin 4	Button Input or LED Driver
Pin 5	Button Input or LED Driver
Pin 6	Button Input or LED Driver
Pin 7	Button Input or LED Driver
Pin 8	Button Input or LED Driver
Pin 9	600 ohm balanced line out +
Pin 10	600 ohm balanced line out -

A.3 Output Connectors + 1 Relay

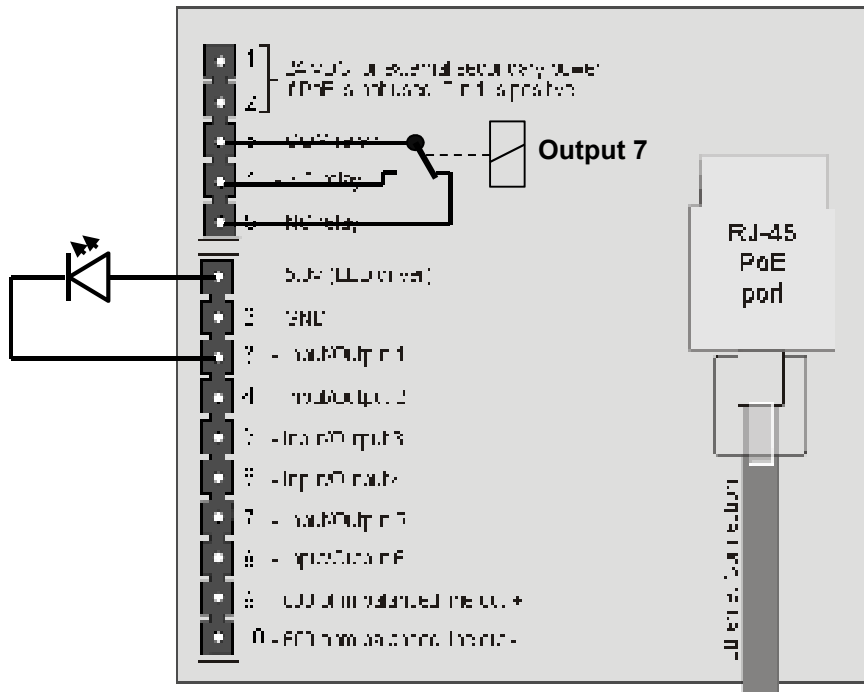

The extra relay for any of the 6 I/O pins is connected as shown:

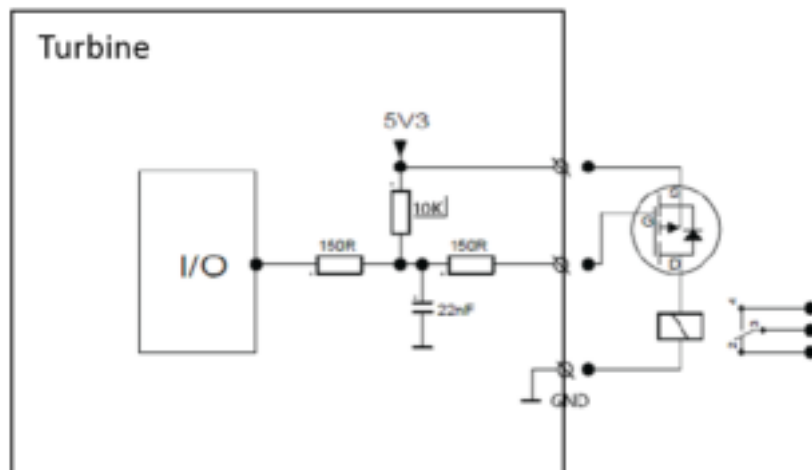

A.4 Output Connectors + MRBD Relay Board

Outputs can be used together with the Multi Relay Board (MRBD) to provide up to 6 additional relay contacts.

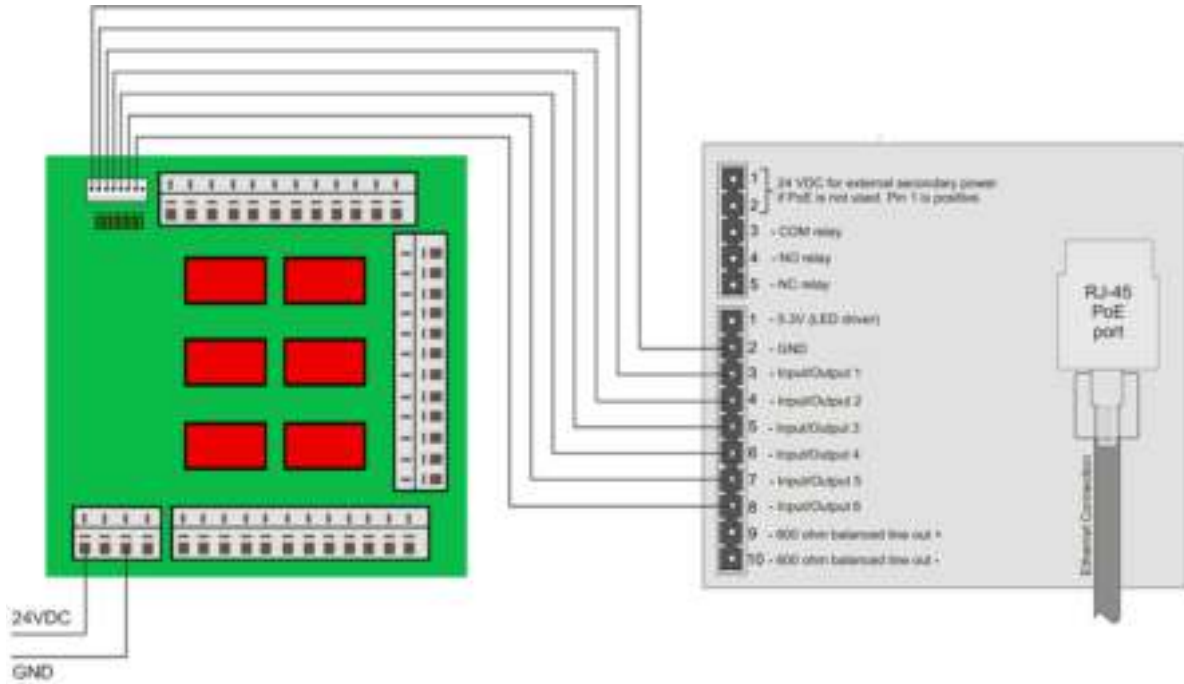

A.5 PCB - Rear

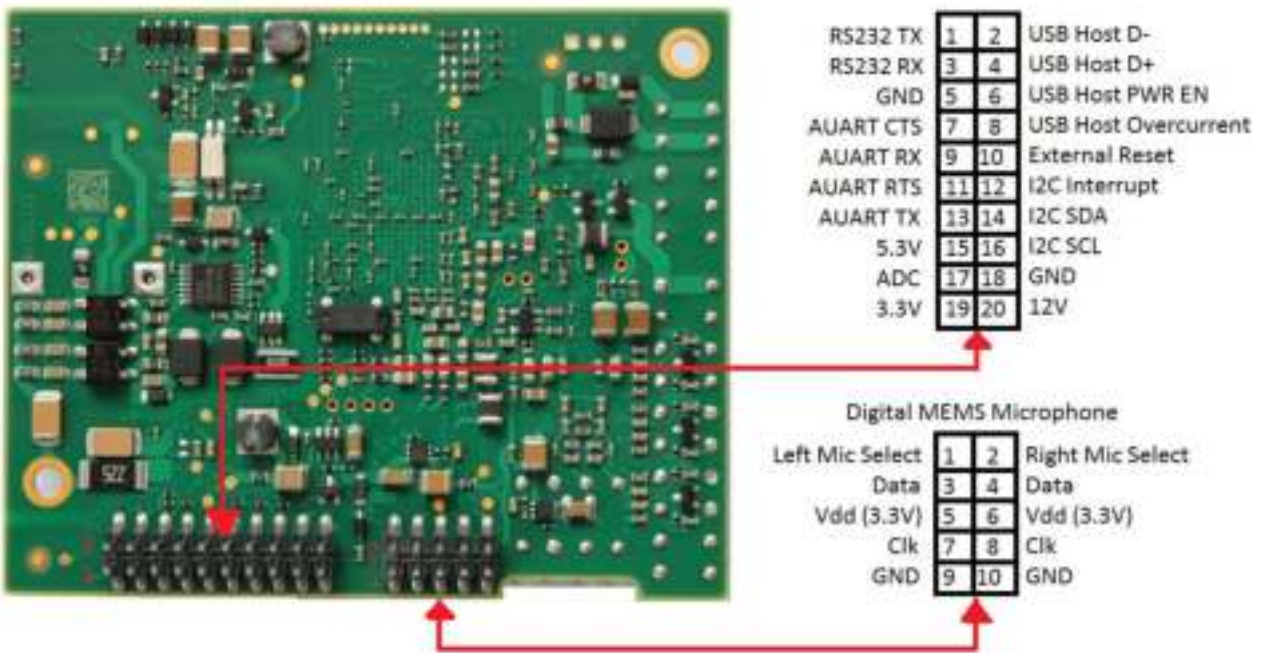

J6 10-pin terminal for digital MEMS Microphone

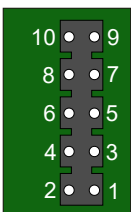

- Pin 1 Left mic select (Vdd)
- Pin 2 Right mic select (GND)
- Pin 3 Data
- Pin 4 Data
- Pin 5 Vdd 3.3V
- Pin 6 Vdd 3.3V
- Pin 7 CLK
- Pin 8 CLK
- Pin 9 GND
- Pin 10 GND

A.6 Front Board - Front

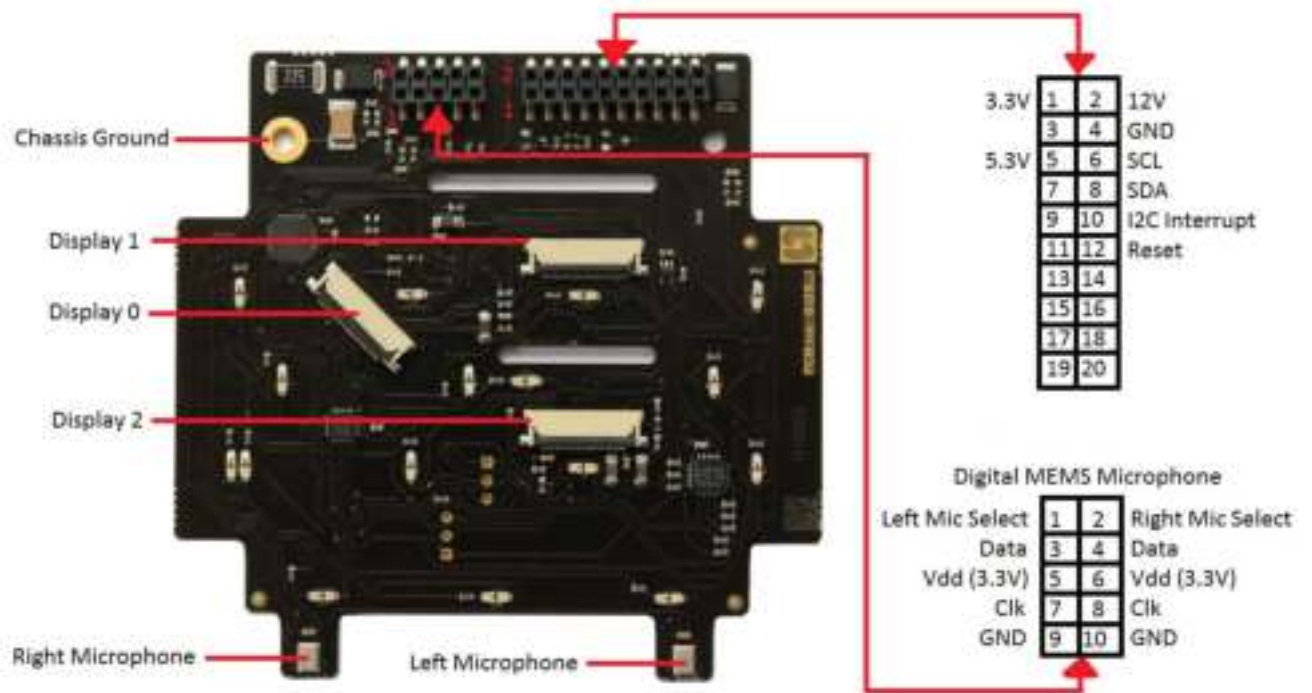

A.7 Front Board - Rear

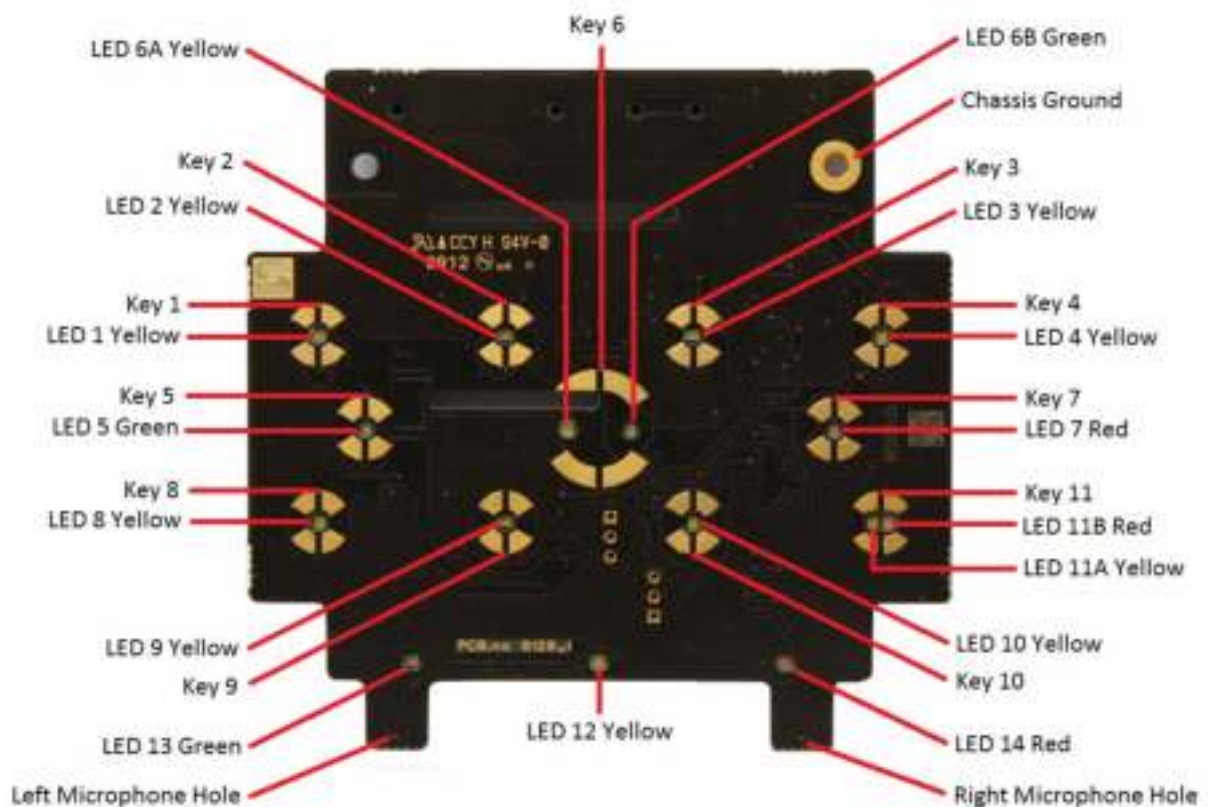

B: Extended Board Connectors

B.1 PCB - Front

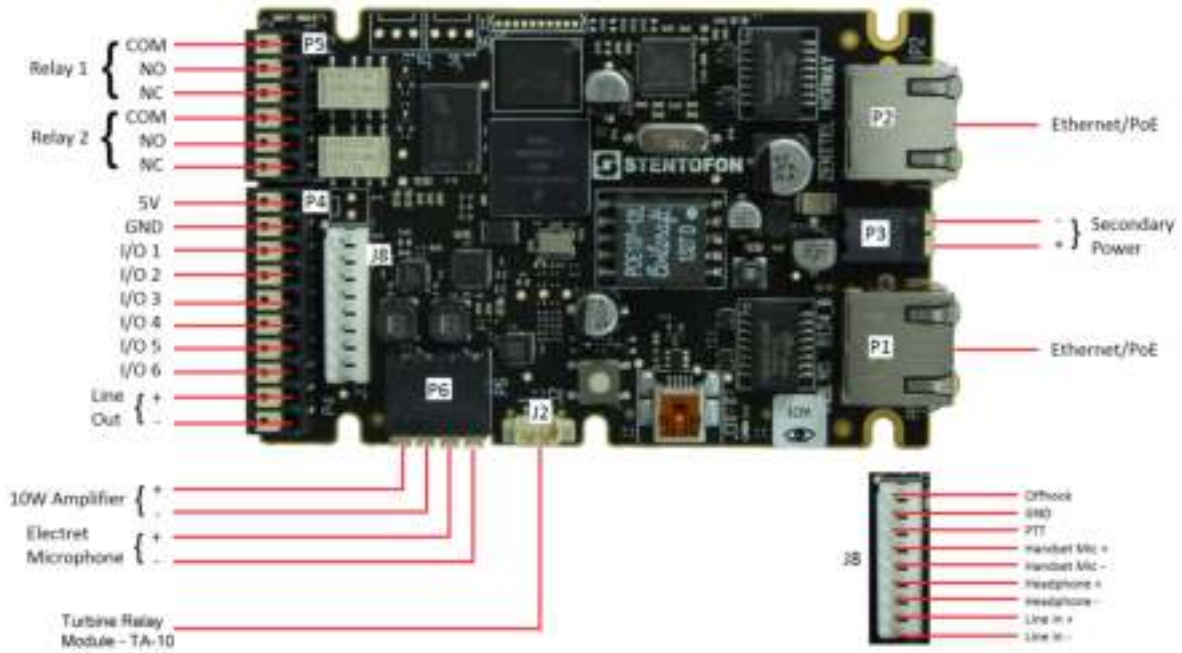

P1/P2 RJ45 PoE ports for 10/100 Mbit Ethernet connection. The station can be powered from these ports if the line supports Power over Ethernet (PoE).

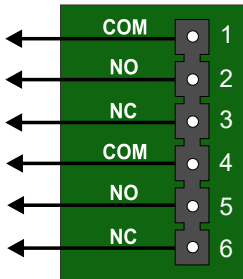

P5 6-pin plug-on terminal for external relay connections.

- Pin 1 COM relay
- Pin 2 NO relay
- Pin 3 NC relay
- Pin 4 COM relay
- Pin 5 NO relay
- Pin 6 NC relay

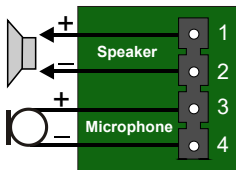

P6 Loudspeaker & Electret microphone

- Pin 1 10W Speaker amplifier +
- Pin 2 10W Speaker amplifier -
- Pin 3 Electret Microphone +
- Pin 4 Electret Microphone -

B.2 Input Connectors

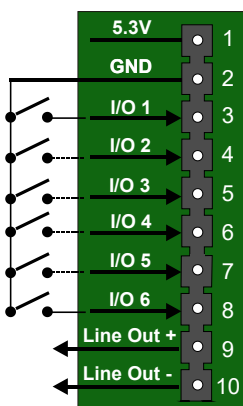

P4 10-pin plug-on terminal for external connections.

- Pin 1 5.3V
- Pin 2 GND
- Pin 3 Button Input or LED Driver
- Pin 4 Button Input or LED Driver
- Pin 5 Button Input or LED Driver
- Pin 6 Button Input or LED Driver
- Pin 7 Button Input or LED Driver
- Pin 8 Button Input or LED Driver
- Pin 9 600 ohm balanced line out +
- Pin 10 600 ohm balanced line out -



The WEEE Directive does not legislate that Zenitel, as a 'producer', shall collect 'end of life' WEEE.

This 'end of life' WEEE should be recycled appropriately by the owner who should use proper treatment and recycling measures. It should not be disposed to landfill.

Many electrical items that we throw away can be repaired or recycled. Recycling items helps to save our natural finite resources and also reduces the environmental and health risks associated with sending electrical goods to landfill.



Under the WEEE Regulations, all new electrical goods should now be marked with the crossed-out wheeled bin symbol shown.

Goods are marked with this symbol to show that they were produced after 13th August 2005, and should be disposed of separately from normal household waste so that they can be recycled.