



Operation Manual

DV-1104



Powered by **Direct IP™**

Before reading this manual

This operation manual contains basic instructions on installing and using DirectIP™ VA in the Box, an IDIS product. Users who are using this product for the first time, as well as users with experience using comparable products, must read this operation manual carefully before use and heed to the warnings and precautions contained herein while using the product. Safety warnings and precautions contained in this operation manual are intended to promote proper use of the product and thereby prevent accidents and property damage and must be followed at all times. Once you have read this operation manual, keep it at an easily accessible location for future reference.

- The manufacturer will not be held responsible for any product damage resulting from the use of unauthorized parts and accessories or from the user's failure to comply with the instructions contained in this operation manual.
- It is recommended that first-time users of this network camera and individuals who are not familiar with its use seek technical assistance from their retailer regarding product installation and use.
- If you need to disassemble the product for functionality expansion or repair purposes, you must contact your retailer and seek professional assistance.
- Both retailers and users should be aware that this product has been certified as being electromagnetically compatible for commercial use. If you have sold or purchased this product unintentionally, please replace with a consumer version.

Safety Precautions

	CAUTION RISK OF ELECTRIC SHOCK DO NOT OPEN	
CAUTION: TO REDUCE THE RISK OF ELECTRIC SHOCK, DO NOT REMOVE COVER (OR BACK). NO USER-SERVICEABLE PARTS INSIDE. REFER SERVICING TO QUALIFIED SERVICE PERSONNEL.		



The lightning flash with arrowhead symbol, within an equilateral triangle, is intended to alert the user to the presence of uninsulated "dangerous voltage" within the product's enclosure that may be of sufficient magnitude to constitute a risk of electric shock.



The exclamation point within an equilateral triangle is intended to alert the user to the presence of important operating and maintenance (servicing) instructions in the literature accompanying the appliance.

Safety Precautions

Important Safeguards

1. Read Instructions

All the safety and operating instructions should be read before the appliance is operated.

2. Retain Instructions

The safety and operating instructions should be retained for future reference.

3. Cleaning

Unplug this equipment from the wall outlet before cleaning it. Do not use liquid aerosol cleaners. Use a damp soft cloth for cleaning.

4. Attachments

Never add any attachments and/or equipment without the approval of the manufacturer as such additions may result in the risk of fire, electric shock or other personal injury.

5. Water and/or Moisture

Do not use this equipment near water or in contact with water.

6. Ventilation

Place this equipment only in an upright position. This equipment has an open-frame Switching Mode Power Supply (SMPS), which can cause a fire or electric shock if anything is inserted through the ventilation holes on the side of the equipment.

7. Accessories

Do not place this equipment on an wall or ceiling that is not strong enough to sustain the camera. The equipment may fall, causing serious injury to a child or adult, and serious damage to the equipment. Wall or shelf mounting should follow the manufacturer's instructions, and should use a mounting kit approved by the manufacturer.



This equipment and cart combination should be moved with care. Quick stops, excessive force, and uneven surfaces may cause the equipment and cart combination to overturn.

8. Power Sources

This equipment should be operated only from the type of power source indicated on the marking label. If you are not sure of the type of power, please consult your equipment dealer or local power company. You may want to install a UPS (Uninterruptible Power Supply) system for safe operation in order to prevent damage caused by an unexpected power stoppage. Any questions concerning UPS, consult your UPS retailer.

9. Power Cord

Operator or installer must remove power and TNT connections before handling the equipment.

10. Lightning

For added protection for this equipment during a lightning storm, or when it is left unattended and unused for long periods of time, unplug it from the wall outlet and disconnect the antenna or cable system. This will prevent damage to the equipment due to lightning and power-line surges. If thunder or lightning is common where the equipment is installed, use a surge protection device.

11. Overloading

Do not overload wall outlets and extension cords as this can result in the risk of fire or electric shock.

12. Objects and Liquids

Never push objects of any kind through openings of this equipment as they may touch dangerous voltage points or short out parts that could result in a fire or electric shock. Never spill liquid of any kind on the equipment.

13. Servicing

Do not attempt to service this equipment yourself. Refer all servicing to qualified service personnel.

14. Damage requiring Service

Unplug this equipment from the wall outlet and refer servicing to qualified service personnel under the following conditions:

- A. When the power-supply cord or the plug has been damaged.
- B. If liquid is spilled, or objects have hit the equipment.
- C. If the equipment has been exposed to rain or water.
- D. If the equipment does not operate normally by following the operating instructions, adjust only those controls that are covered by the operating instructions as an improper adjustment of other controls may result in damage and will often require extensive work by a qualified technician to restore the equipment to its normal operation.
- E. If the equipment has been dropped, or the cabinet damaged.
- F. When the equipment exhibits a distinct change in performance — this indicates a need for service.

15. Replacement Parts

When replacement parts are required, be sure the service technician has used replacement parts specified by the manufacturer or that have the same characteristics as the original part. Unauthorized substitutions may result in fire, electric shock or other hazards.

16. Safety Check

Upon completion of any service or repairs to this equipment, ask the service technician to perform safety checks to determine that the equipment is in proper operating condition.

17. Field Installation

This installation should be made by a qualified service person and should conform to all local codes.

18. Correct Batteries

Warning: Risk of explosion if battery is replaced by an incorrect type. Replace only with the same or equivalent type. Dispose of used batteries according to the instructions. The battery shall not be exposed to excessive heat such as sunshine, fire or the like.

19. Tmra

A manufacturer's maximum recommended ambient temperature (Tmra) for the equipment must be specified so that the customer and installer may determine a suitable maximum operating environment for the equipment.

20. Elevated Operating Ambient Temperature

If installed in a closed or multi-unit rack assembly, the operating ambient temperature of the rack environment may be greater than room ambient. Therefore, consideration should be given to installing the equipment in an environment compatible with the manufacturer's maximum rated ambient temperature (Tmra).

21. Reduced Air Flow

Installation of the equipment in the rack should be such that the amount of airflow required for safe operation of the equipment is not compromised.

22. Mechanical Loading

Mounting of the equipment in the rack should be such that a hazardous condition is not caused by uneven mechanical loading.

23. Circuit Overloading

Consideration should be given to connection of the equipment to supply circuit and the effect that overloading of circuits might have on over current protection and supply wiring. Appropriate consideration of equipment nameplate ratings should be used when addressing this concern.



24. Reliable Earthing (Grounding)

Reliable grounding of rack mounted equipment should be maintained.

Safety Precautions

Particular attention should be given to supply connections other than direct connections to the branch circuit (e.g., use of power strips).

In-Text

Symbol	Type	Description
	Caution	Important information concerning a specific function.
	Note	Useful information concerning a specific function.

User's Caution Statement

Caution: Any changes or modifications to the equipment not expressly approved by the party responsible for compliance could void your authority to operate the equipment.

FCC Compliance Statement

THIS EQUIPMENT HAS BEEN TESTED AND FOUND TO COMPLY WITH THE LIMITS FOR A CLASS A DIGITAL DEVICE, PURSUANT TO PART 15 OF THE FCC RULES. THESE LIMITS ARE DESIGNED TO PROVIDE REASONABLE PROTECTION AGAINST HARMFUL INTERFERENCE WHEN THE EQUIPMENT IS OPERATED IN A COMMERCIAL ENVIRONMENT. THIS EQUIPMENT GENERATES, USES, AND CAN RADIATE RADIO FREQUENCY ENERGY AND IF NOT INSTALLED AND USED IN ACCORDANCE WITH THE INSTRUCTION MANUAL, MAY CAUSE HARMFUL INTERFERENCE TO RADIO COMMUNICATIONS. OPERATION OF THIS EQUIPMENT IN A RESIDENTIAL AREA IS LIKELY TO CAUSE HARMFUL INTERFERENCE, IN WHICH CASE USERS WILL BE REQUIRED TO CORRECT THE INTERFERENCE AT THEIR OWN EXPENSE.

WARNING: CHANGES OR MODIFICATIONS NOT EXPRESSLY APPROVED BY THE PARTY RESPONSIBLE FOR COMPLIANCE COULD VOID THE USER'S AUTHORITY TO OPERATE THE EQUIPMENT. THIS CLASS OF DIGITAL APPARATUS MEETS ALL REQUIREMENTS OF THE CANADIAN INTERFERENCE CAUSING EQUIPMENT REGULATIONS.

WEEE (Waste Electrical & Electronic Equipment)

Correct Disposal of This Product

(Applicable in the European Union and other European countries with separate collection systems)



This marking shown on the product or its literature, indicates that it should not be disposed with other household wastes at the end of its working life. To prevent possible harm to the environment or human health from uncontrolled waste disposal, please separate this from other types of wastes and recycle it responsibly to promote the sustainable reuse of material resources.

Household users should contact either the retailer where they purchased this product, or their local government office, for details of where and how they can take this item for environmentally safe recycling.

Business users should contact their supplier and check the terms and conditions of the purchase contract. This product should not be mixed with other commercial wastes for disposal.

Copyright

© 2017 IDIS Co., Ltd.

IDIS Co., Ltd. reserves all rights concerning this operation manual.

Use or duplication of this operation manual in part or whole without the prior consent of IDIS Co., Ltd. is strictly prohibited.

Contents of this operation manual are subject to change without prior notice for reasons such as functionality enhancements.

Registered Trademarks

IDIS is a registered trademark of IDIS Co., Ltd.

Other company and product names are registered trademarks of their respective owners.

The information in this manual is believed to be accurate as of the date of publication even though explanations of some functions may not be included. We are not responsible for any problems resulting from the use thereof. The information contained herein is subject to change without notice. Revisions or new editions to this publication may be issued to incorporate such changes.

The software included in this product contains some Open Sources. You may obtain the complete corresponding source code from us. See the Open Source Guide on the software CD (OpenSourceGuide\OpenSourceGuide.pdf) or as a printed document included along with the User's Manual.

Table of Contents

1

Part 1 – Introduction.....	8
Product Features	8
Accessories.....	11
Overview	11
Front Panel.....	11
Rear Panel	12
Firmware Upgrade	13
Camera Protocol.....	13

2

Part 2 - Remote Setup.....	13
Troubleshooting	14
Specifications	14

3

Part 3 - Appendix.....	14
-------------------------------	-----------

Part 1 – Introduction

Product Features

This VA in the Box (VA Box) analyzes the live video from DirectIP™ cameras and transmits the video over Ethernet connections. This product offers the following features:

- Video Inputs : 4-channel H.264 and H.265 IP camera
- DirectIP™ protocol supported
- Convenient firmware upgrades via network
- Firmware duplication and autorecovery functions to enhance system stability
- Various image analysis function such as People Counting, Heat Map and Queue Management
 - People Counting : Counts the number of people passing through the line on the video
 - Heat Map : Analyzes the person flows or traffic of the settings area on the video
 - Queue Management : Counts and manages time and the number of people who have stayed in the setting zone
- Configuration of device settings and integrated management of multiple VA Boxes on the NVR (Network Video Recorder)

Example 1 : VA Box Connection Diagram Using PoE Switch

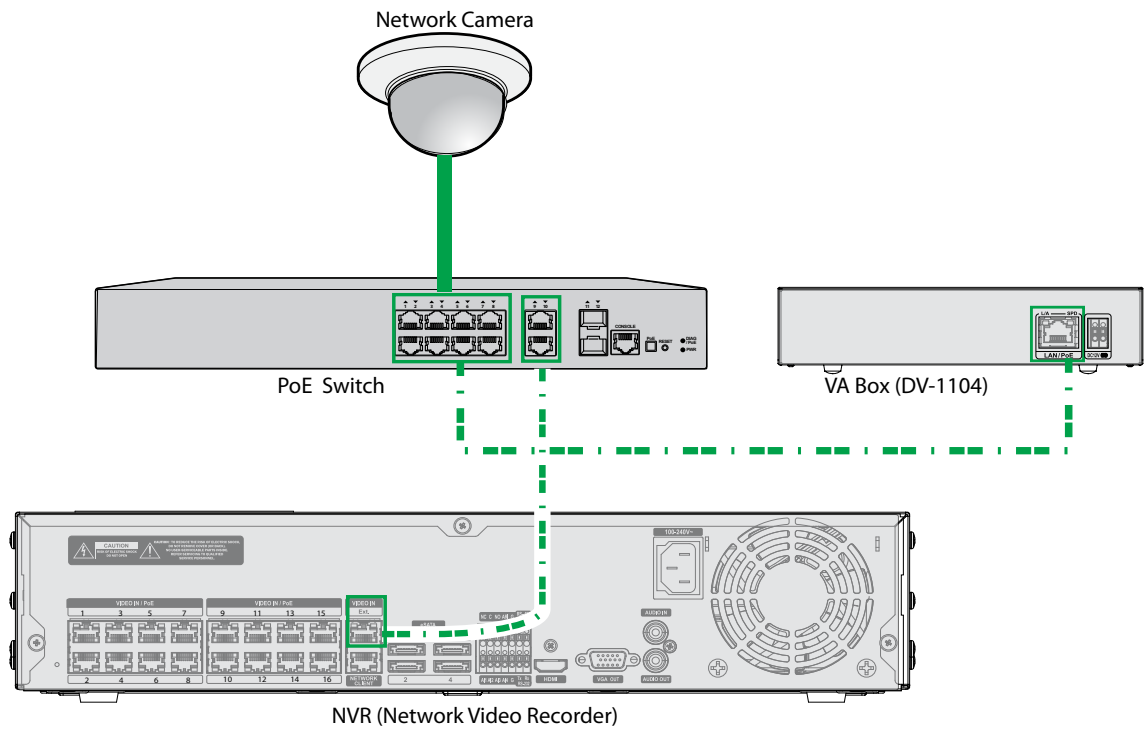

Example 2 : VA Box Connection Diagram Using PoE Switch

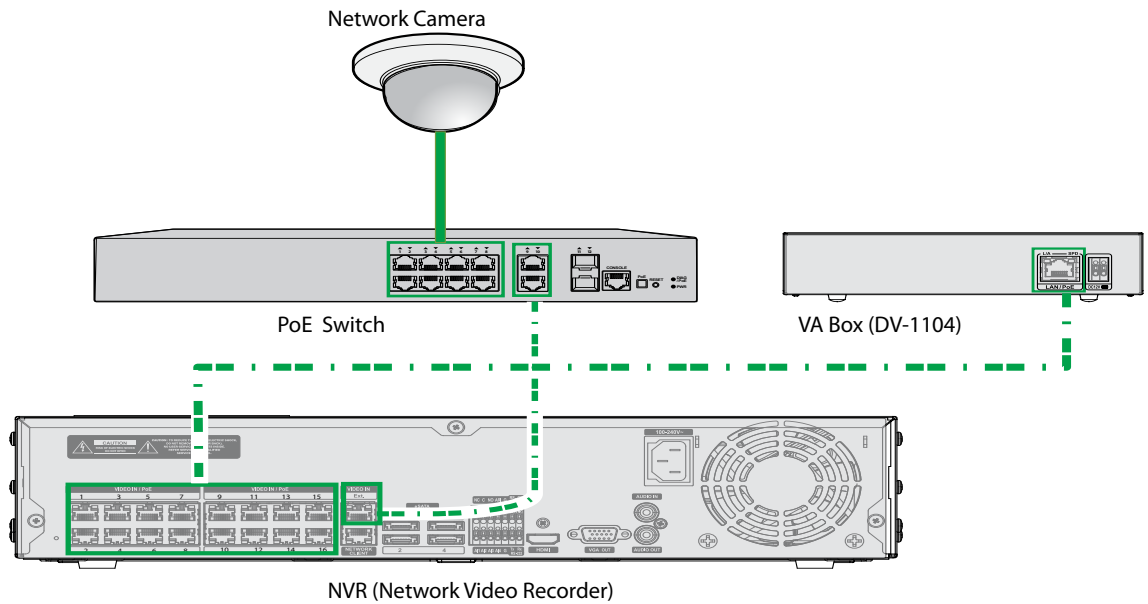

Example 3 : VA Box Connection Diagram Using PoE Switch

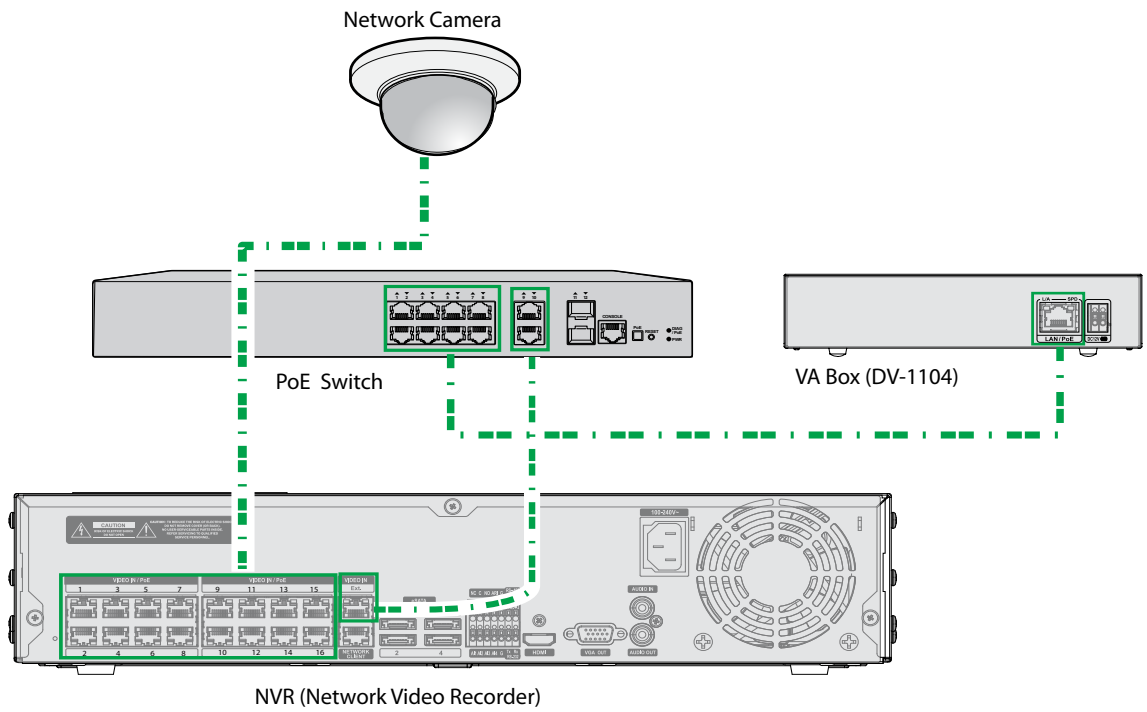

Example 4 : VA Box Connection Diagram without PoE Switch

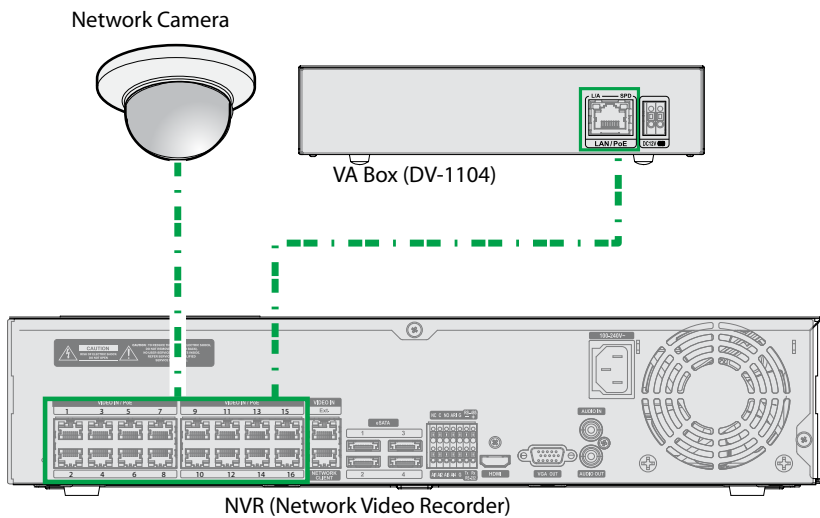

Types of Cables



LAN Cable (Data + PoE Power)

Accessories

Upon unpacking the product, check the contents inside to ensure that all the following contents are included.

- VA in the Box
- User Guide and Instruction Manual (This document)
- Rubber Foot (4EA)

Overview

Front Panel

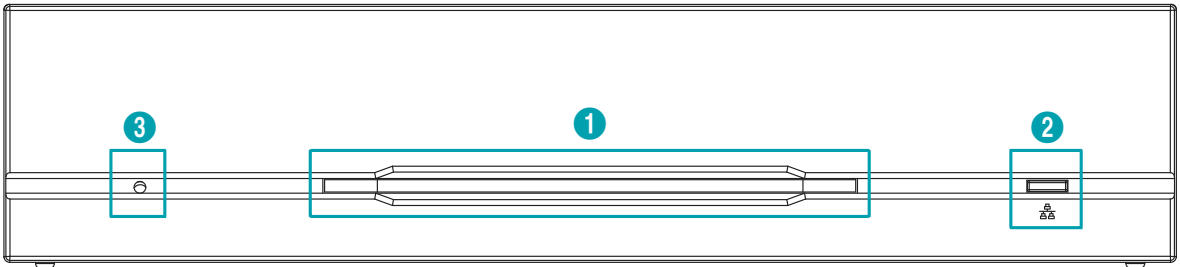

①	Power LED	②	Network LED	③	Factory Reset Switch
---	------------------	---	--------------------	---	-----------------------------

① Power LED

Displays system operating status

② Network LED

Displays network connection status

LED Status Indications

LED	Status	Description
Power LED	Off	No power connection
	Blinking	System booting or upgrading
	On	System operating
Network LED	Blinking	Normal network connection

③ Factory Reset Switch

Use to return all settings to the original factory settings. Connect the power and poke a straightened paperclip into the factory reset switch hole. Hold the reset switch until the VA Box’s internal buzzer sounds twice. Release the reset switch, and all of the device settings are now at the original settings it had when it left the factory.

- **Factory Reset during system booting:** All of the VA Box's settings are now at the original settings it had when it left the factory.
- **Factory Reset during system operating:** The other settings except for system log are now at the original settings it had when it left the factory.
- **Factory Reset via the IDIS Discovery program:** The other settings except for system log and network settings are now at the original settings it had when it left the factory.
- **Factory Reset via the IDIS Discovery program(including network settings) :** The other settings except for system log are now at the original settings it had when it left the factory.

Rear Panel

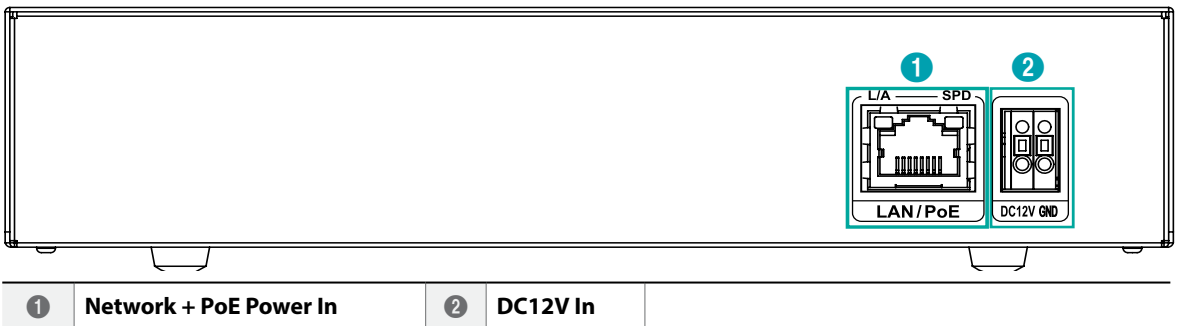

① Network + PoE Power In

Connect a Cat5e cable with an RJ-45 jack. The device is capable of connecting to networks via an Ethernet connector and also receives power (PoE) from the NVR.

② DC12V In

Connect the two wires of the power adapter to these ports. Be careful not to cross the DC12V and ground (GND) wires. Booting will commence once connected to a power supply.

- ✓ The network connector is not designed to be connected directly with cable or wire intended for outdoor use.
- ⚠ Ground the power port's ground terminal before use.
- Organize the power cable so that it will not cause people to trip over or become damaged from chairs, cabinets, desks, and other objects in the vicinity. Do not run the power cable underneath a rug or carpet.
- Do not connect multiple devices to a single power outlet.

Part 2 - Remote Setup

Configure basic VA Box settings and all other system settings.



- Screen images may vary depending on the model.
- When using the camera with Intelligent Codec, it could delay the image analysis up to 10 seconds.



- MAT (Motion Adaptive Transmission) function is active, the image analysis may not work normally.
- It is recommended that you do not use MAT function to increase the accuracy of image analysis.

Camera Protocol

VA Box supports **DirectIP™** protocol.

- **DirectIP™** protocol:
 - Using with a DirectIP™ NVR enables VA Box use without the need to configure network settings.
 - The DirectIP™ NVR also allows you to control all VA Box settings directly from the NVR, without the need for a computer.
- For more information on configuring VA Box settings from a DirectIP™ NVR, refer to the **VA in the Box Setup via NVR on page 18**.
- For more information about video analysis report, refer the **Video Analysis Report (VA Box) via IDIS Center Program on page 22**.

Firmware Upgrade

Refer to the **Upgrade on page 21** to perform a firmware upgrade.

Part 3 - Appendix

Camera Installation Guidelines for VA Box

General Guidelines

In order for the camera and, in effect, the functions of the VA Box such as Heat Map, People Counting and Queue Management to operate properly, make sure that the following information is applicable.

- It applies to People Counting, Heat Map and Queue Management function of the VA Box.

① Make sure that the lighting is sufficient.

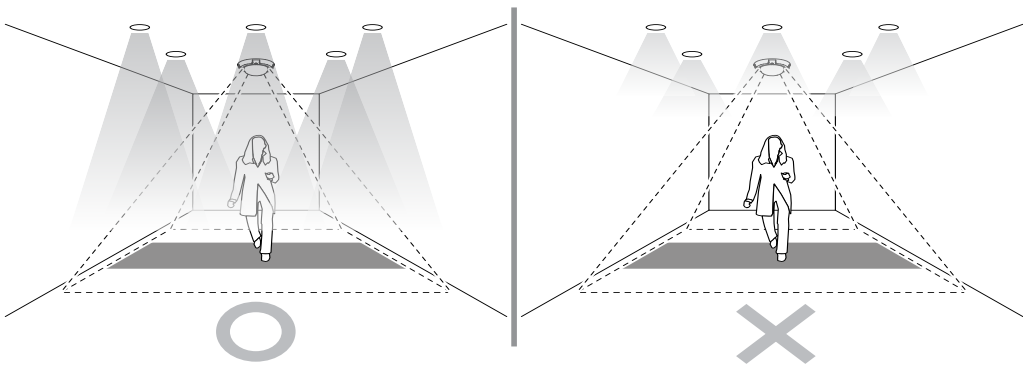

[Make sure there is enough light]

② Try to avoid getting very strong light and sharp shadows in the camera view.

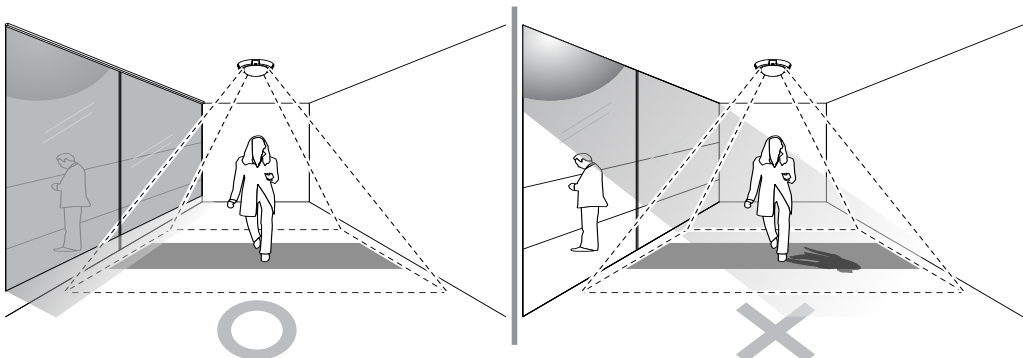

[Avoid having direct sunlight into the setting area.]

③ Do not mount the camera, for instance, above an escalator or the floor is moving.

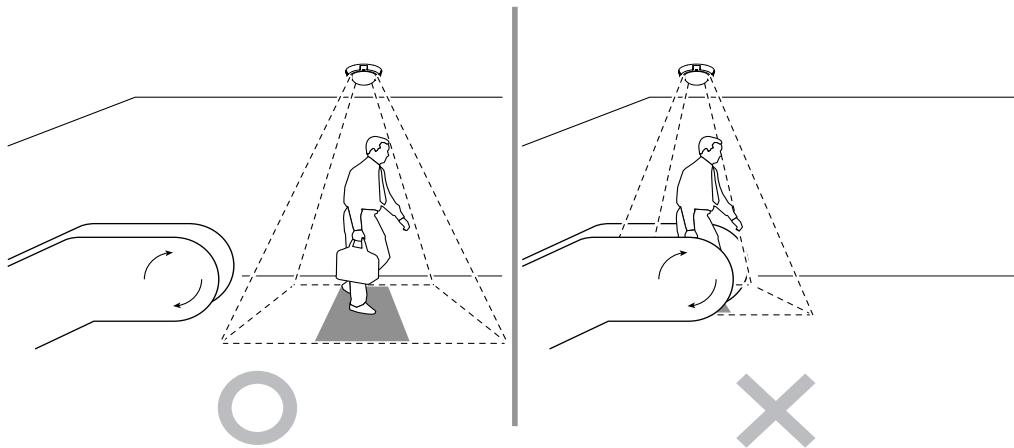

[Avoid having moving objects such as an escalator steps in the setting area.]

④ Make sure that no doors or other items are moving in the event area.

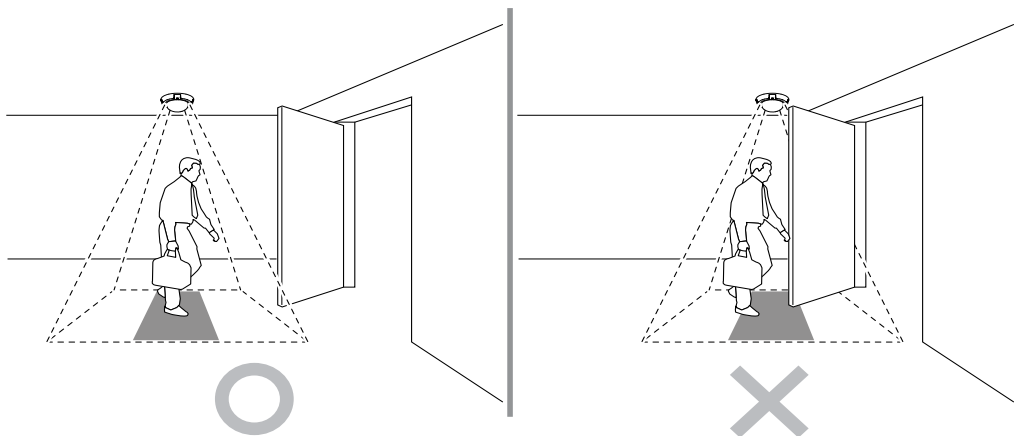

[Avoid having the camera blocked when you open the door]



The People Counting, Queue Management and Heatmap functions of the VA in the Box are intended to collect statistical baseline data for marketing purposes, not for real-time accuracy purposes. There may be errors in the actual measurement.

In the following conditions, a detection performance may be reduced.

- If there is not enough light.
- If it is difficult to obtain sufficient view.
- If the object color is similar to the background color.
- If only part of the object is visible at the edge of the field of view.
- When extremely fast moving several objects appear randomly in the image.
- When an object stays in the same place for a long time without moving.
- When a person is lying down or sitting without standing upright.
- When the object is too close to the camera.
- When several people move in groups and their motions block one another.
- When the object moves quickly.
- If an object is reflected on the floor, wall, glass, metal or water or the light makes shadows.
- When the weather situation is bad (ex: rain, snow, winds, etc) or it is time for sunset or sunrise.
- If the position of the camera differs from the direction of a light source and it makes a shadow.
- If there is a blinking light source.
- If the surface of the floor is reflective or the wall is transparent.

People Counting, Queue Managment

Camera Installation

The camera should be mounted straight above the place where people should be counted and should be looking straight down.

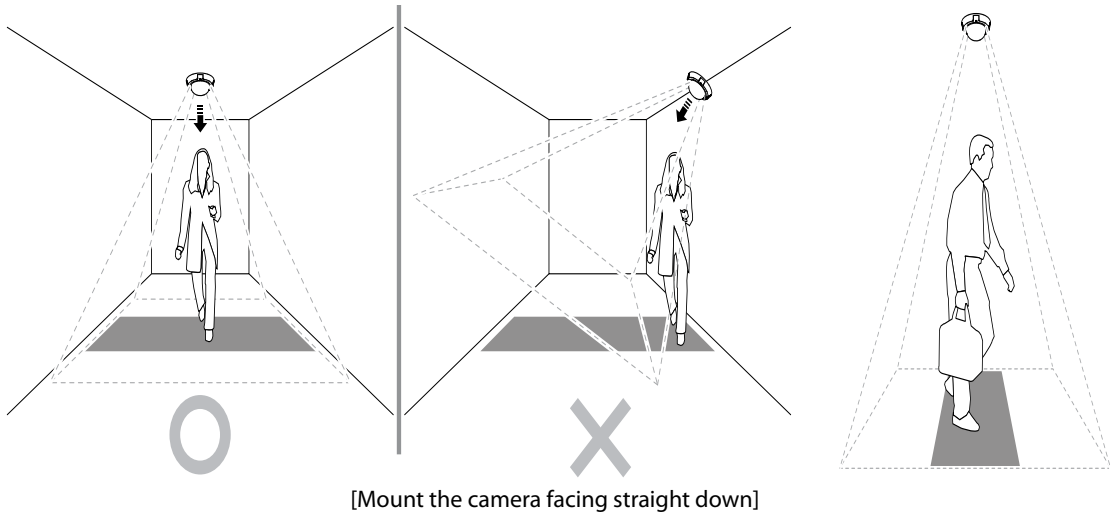

It will not count objects under about 110 to 130 cm of height depending on the camera model (Only for People Counting function).

Camera Position

Adjust the position of the camera so that people can pass through the camera's view vertically. The camera should be mounted so that the counted person can pass through the virtual black part.

Height and Width

The mounting height range of the camera should be from 270 cm and it depends on the model. The recommended minimum height is 300 cm. Depending on the camera model and zoom setting, the height and width can be adjusted. The maximum width that most of the camera can cover is about 5 meters.

Heat Map

Camera Installation

The camera should be mounted facing down to 15~35°C



NVR and Camera Compatibility

Only IDIS cameras that supports DirectIP™ are supported and some models may not be supported. NVR and camera compatibility contents are subject to change without notice. Contact your retailer for the latest compatibility chart.

NVR Model
DR-6308P / DR-6308P-S / DR-6316PS / DR-6316PS-S / DR-6332PS / DR-6332PS
DR-8364 / DR-8364D
DR-2304P / DR-2308P / DR-2316P
DR-4308P / DR-4316PS

VA in the Box Setup via NVR

Select **1 VA Box Setup** from the setup menu.

Login with an ID that has permission to access the setup menu is needed to access and make changes to the Setup menu.

- 1 While in Live mode, press the remote control's **SETUP** button or select Live menu > Setup using the mouse.



- 2 Use the remote control's arrow buttons to select an option and then press the remote control's **↩** button or left-click on the option using the mouse.

VA Box Setup



VA Box can only analyze the video from the camera using H.264 and H.265..

Registration

You can register VA Box at remote locales.



- **Title:** Edit the VA Box's name.
- **MAC Address:** Displays the VA Box's MAC address registered to the NVR.
- **Address:** Displays the VA Box's IP address registered to the NVR.
- **Model:** Indicates the VA Box's model.
- **Scan:** Select to scan and register the device connected to the NVR.

Device Scan

Scan the device under **Registration - Scan.**



- **No.:** Select the registered VA Box number and click the **Add Box** button to register the camera.
- **MAC Address:** Displays the scanned device's MAC address.
- **Address:** Displays the scanned device's IP address.
- **Model:** Indicates the device model.
- **Registered Device MAC Address:** Displays the MAC address of the NVR to have registered VA Box.
- **Status:** The "Registered" indicates the VA Box is registered to the NVR and "Not registered" indicates the VA Box is not registered to the NVR.

Setup

Configure VA Box-related settings.



- **Title:** Displays the scanned device's name.
- **Camera:** Select the camera to analyze the video. Only one camera can set for each VA Box channel.



The video analytics may not be supported depending on the model.

- **Analytic Type:** Select one among People Counting, HeatMap and Queue Management. A single video analysis function is available for each VA Box channel.

People Counting

Count the number of people passing through the line (designated border) on the live screen.



Right-click on the zone setup screen to bring up the the People Counting Menu.

- **Crossing Line:** Set a virtual border to count the floating population.
- **Head:** Set a size of a head on the screen based on the floating population.

A miscount may occur when a head is set too large or too small.

- **Freeze:** You can pause the live screen.
- **Save:** Save the changes and exit the menu.
- **Cancel:** Exit the setup screen without saving the changes.

HeatMap

Analyze the movement frequency in the zone of the live screen. Use the left mouse button to define the zone. Drag and drop the apex to modify previously setting zone and click on the left mouse button to delete the zone.



Lines cannot across when setting the zone.

Right-click on the zone setup screen to bring up the the HeatMap Menu.

- **Undo:** Return to its previously setting zone.
- **Save:** Save the changes and exit the menu.
- **Cancel:** Exit the setup screen without saving the changes.

Queue Management

Manage the number of people and extend of stay in the the setting zone. Use the left mouse button to define the zone. Drag and drop the apex to modify previously setting zone and click on the left mouse button to delete the zone. You can create a max of three zones.



Lines cannot across when setting the zone.

Right-click on the zone setup screen to bring up the the Queue Management Menu.

- **Delete:** Delete the zone selected in the image.
- **Undo:** Return to its previously setting zone.
- **Save:** Save the changes and exit the menu.
- **Cancel:** Exit the setup screen without saving the changes.

- **Configuration:** Configure the details of the VA Box. Select the VA Box's **Analytic Type** first before you use this setup.



- **Object Tracking:** The object tracking slider sets the sensitivity. The closer the level is to the **Sensitive**, the more device can track the movement sensitively.
- **Dynamic Background Suppression:** Recognize the objects (people) even if the background is moving.
- **Light Disturbance :** Recognize the objects in the lighting conditions such as sunlight.
- **Shadow Suppression:** Set not to recognize the shadow as an object.
- **FishEye:** In any the camera is tilted, recognize the lower and upper body together, not separate.
- **Cooldown:** Indicate the HeatMap information recorded before **Cooldown** on the screen.
 - Cooldown function is only supported if the **Analytic Type** is set to HeatMap.
- **Detection Reference Time (sec.) :** Set the time to detect objects in the queue management zone. It detects when the objects (people) stay longer than time frame set in the defined area.
 - Detection Reference Time (sec.) is only supported if the **Analytic Type** is set to Queue Management.
- **Reset:** Resets the port or cameras.
 - **PoE Reset:** Control the PoE Switch's port. This option is available when connecting to Video In/ PoE port or using a DirectIP™ PoE Switch (optional). Select PoE Reset to reboot the camera. It is not supported by video encoders.
 - **Soft Reset:** Reboots the camera.
 - Access the clients such as the IDIS Center to check the analysis results.

Schedule

Configure the schedule of the VA Box. Select the + button on the bottom left of the screen to add a schedule. Select Day to specify the Day setting or select All. Select Scope to specify the time frame.



- Deleting the schedules suspends the real-time video analysis.

Upgrade

When using NetFS, select Firmware Upgrade. You can select USB port or NetFS. If not, you can only select USB port. Select USB port to display USB search window and then select the corresponding upgrade package from the storage device connected to the NVR's USB port. After selecting an upgrade package, select Apply to upgrade the VA Box.



- If an upgrade attempt fails, an upgrade failure message will be displayed. Refer to **Error Code Types in the installation manual** for more details.
- The VA Box will reboot after the upgrade and then reconnect automatically.

Video Analysis Report (VA Box) via IDIS Center Program

Searches video analysis information and analyze with graphs and images by using devices connected to VA Box. Video Analysis Report is supported in the VA Box panels (max. 3). Select **New Tab** from the **System** menu and click **VA Box** to add a tab.

Connection and Search

- 1 Select a device from the devices connected to VA Box on the **Site** list, and drag and drop on the device VA Box panel. When connected, the name of the device is displayed on the top right of the panel, and time search, VA function and device select options are activated at the bottom left.

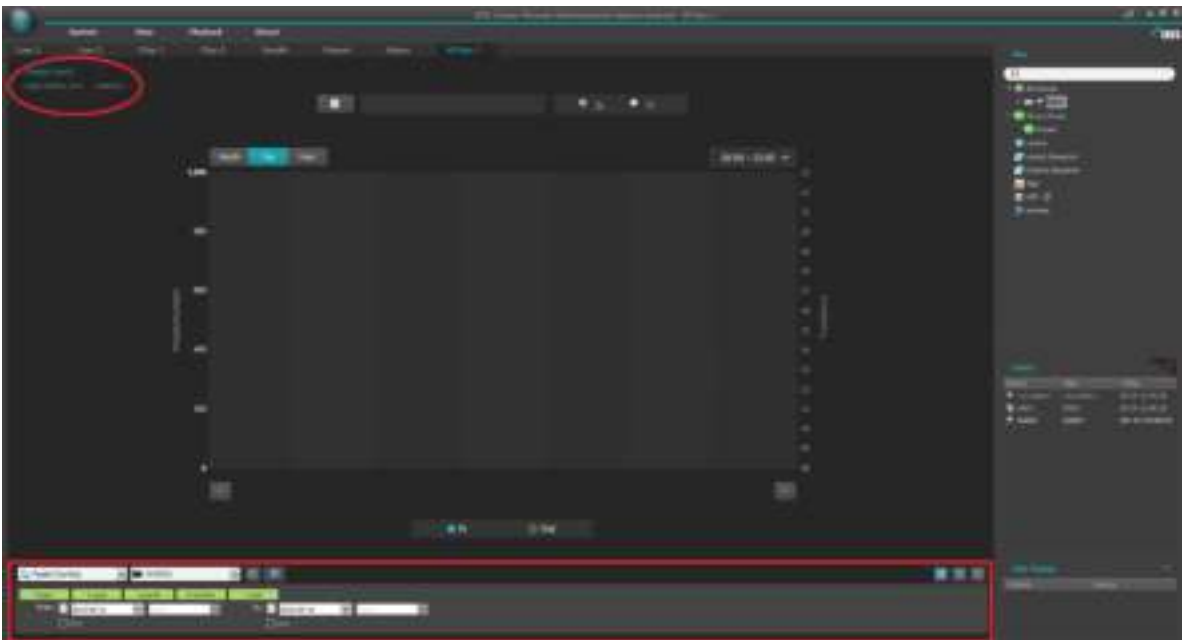



- 2 Select a VA function (People Counting, Queue Management, Heat Map) page from the bottom left combo box.
- 3 Select a VA device and time range, and click Search button () to see the video analysis data as a graph and image.
- 4 Drag and drop other device on the VA Box panel to change the device. Select Logout from the System menu to disable the device.

Report Toolbar

Use the toolbar at the bottom of the panel to search a specific VA report.



- **From, To:** Set the date and time of the VA report to search for. Enter a specific date and time or select **First** or **Last** options. Select from **Today, 1 week, 1 month, 6 months** or **1 year** to adjust the **From** and **Last** interval.
-  (VA function): Select a VA function page.
-  (VA device): Select a VA Box device.
-  (Full Screen): Shows the Report Panel in full screen.



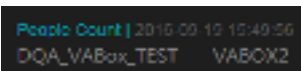

Page Information





- Current VA page type
- Current time of the VA report search
- The name of the device connected to VA Box
- The name of VA Box device



People Counting



- **Total In/Total Out:** Displays the total number of In/Out counts of the current page period.
-  : Select a specific date from the calendar.
- **Search Period:** Displays the search period of the current page.
-  : Select between a bar graph and a line graph.
-  : Select the X-axis value (Month, Day, Hour).
-  : Select from **08:00~23:00, 24 Hour, AM, PM** to display people counting of the specific time zone according to the selected time unit, as a bar or line graph. The number of people is displayed on the graph.
- **People(Number):** The left Y-axis indicates the value of the bar/line graph.
- **Time(Hour):** The right Y-axis indicates the time of numbers on the graph.

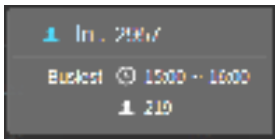





-  : Move backward by 1 year (Month), 1 week (Day), 1 day (Hour) according to the search period unit.
-  : Move forward by 1 year (Month), 1 week (Day), 1 day (Hour) according to the search period unit.
-  : Select between In/Out to see each data.
- **Graph Tooltip:** Hovering the mouse over the bar/line graph displays the Tooltip information.





-  In : 2967 : Indicates the number of people of the selected data.
-  : Indicates the busiest time of the selected data.
-  : Indicates the number of people during the busiest time of the selected data.

Queue Management





-  : Select a specific date from the calendar.
-  : Move to the date with the previous data.
-  : Move to the date with the later data.
- Search Date: Displays the date of the current page.
-  : Selecting the start time and end time displays the graph of the specific time range.
-  : Select between a bar graph and a line graph.
-  : Select a specific zone to see the data.
- **Graph Tooltip:** Hovering the mouse over the bar/line graph displays the Tooltip information.



-  13:00 - 14:00 : Indicates the time of the selected data.
-  /  : Indicates the number of selected people and the dwell time for each zone.

Heat Map



- **Zone User Edit:** Edit a heat map zone. Check the box to define the zone with a mouse click. Specify the area on the still image with the left mouse button, and click the first point or the right mouse button to complete defining the zone. Press **Delete** to cancel the previous point while specifying the area, and press **Esc** to cancel the entire specification.
- **Date/Time Search:** Selecting the start/end date and start/end time displays corresponding heat map images on a still image and thumbnail images.
- **Still Image:** Displays the latest image of the camera connected to the selected VA Box.
- **Color Schema:** Displays a color schema of a heat map. 4 kinds of color schema are available.
-  : Displays the unit of a single thumbnail.
- **Thumbnail Images:** Displays images divided by a regular time unit, according to the selected date/time above. Hovering the mouse on the thumbnail image displays the enlarged image.
 -  : Displays the previous five thumbnail images.
 -  : Displays the later five thumbnail images.

Troubleshooting

Problem	Check
Power LED will not turn on	<ul style="list-style-type: none"> • Check the LAN cable. • Check that the power cable is connected or the NVR has power.
The system is unable to recognize network interface	<ul style="list-style-type: none"> • Check the LAN cable. • Check the network LED.

Specifications

Model	DV-1104	
Video	Input	1 RJ-45
	Compression	H.264 / H.265
Inputs/ Outputs	Ethernet	10M/100Mbps/1Gbps
	DC12V Input	Terminal Blocks
	LED	Power(Status), Network
	Button/Switch	Reset
Environmental Conditions	Operating Temperature	32°F to 104°F (0°C ~ 40°C)
	Operating Humidity	0% ~ 90%
General	Dimensions (W x H x D)	7.9" x 1.7" x 6.0" (200mm x 44mm x 152.3mm)
	Unit Weight	1.6 lbs. (740g)
	Power Supply	DC12V or PoE (IEEE802.3af class3)
	Power Consumption	6.6W
	Approval	KC, FCC, CE

These product specifications may change without prior notice.



IDIS Co., Ltd.

For more information, please visit at
www.idisglobal.com