

AlphaCom XE

Installation, Configuration & Operation



Document Scope

This document provides a detailed step-by-step guide to the installation and configuration, as well as useful information on system management and operation, of the AlphaCom XE Audio Server product range.

This document should provide adequate information for setting up the system and getting it up and running.

Product Information

| Product | Part Number |
|----------------------------|---|
| AlphaCom XE1 Audio Server | 1009601002 |
| AlphaCom XE7 Audio Server | 1009608000/1009608100/1009608106/1009608300 |
| AlphaCom XE20 Audio Server | 1009621000 |
| AlphaCom XE26 Audio Server | 1009627000/1009627001/1009627002 |

Publication Log

| Rev. | Date | Author | Comments |
|------|------------|--------|-----------------------------------|
| 1.0 | 21.10.2010 | HKL | Published |
| 1.1 | 24.11.2010 | HKL | Revised LCM figures |
| 1.2 | 4.3.2011 | HKL | XE7 backplane fig. |
| 1.3 | 18.3.2011 | HKL | AMC board jumpers |
| 1.4 | 16.7.2012 | HKL | AlphaWiki ref |
| 1.5 | 28.8.2013 | HKL | Port pin-out, RIO cabling |
| 1.6 | 31.01.2014 | ER | Last § 2.2.3 deleted |
| 1.7 | 8.6.2015 | HKL | Battery § 2.2.7 |
| 1.8 | 12.5.2016 | SEN | IP protocol v6 deleted from spec. |
| 1.9 | 04.05.2017 | SEN | Added Dutch to language packages |

Related Documentation

For further information, refer to the following documentation:

| Doc. no. | Documentation |
|------------|--|
| A100K10176 | RIO Remote Input/Output Unit |
| A100K10300 | Prison Technical Manual |
| A100K10390 | SIP GSM Gateway MV-370 |
| A100K10333 | SIP Analog Gateway AudioCodes MP-114/118 |
| A100K10313 | Network Design Guide |
| A100K10590 | Billing System Configuration Guide |
| A100K10610 | LCM - Line Connection Module |
| A100K10652 | IP DECT Installation & Configuration |
| A100K10674 | API STENTOFON SDK |
| A100K10777 | IP DECT Quick Configuration |
| A100K10788 | IP Master Station Installation & Configuration |
| A100K10803 | IP Substation Installation & Configuration |
| A100K10845 | SoftClient Installation & Operation |

Contents

| | | |
|----------|--|-----------|
| 1 | The AlphaCom XE System | 6 |
| 1.1 | Flexible, Secure and Safe Operation | 7 |
| 1.1.1 | Restricted management access | 7 |
| 1.1.2 | Separate management interface | 7 |
| 1.1.3 | Internal firewall..... | 7 |
| 2 | Getting Started | 8 |
| 2.1 | Making a Network Plan | 8 |
| 2.2 | Unpacking and Installing Hardware | 9 |
| 2.2.1 | Installing the AlphaCom XE1 cabinet..... | 9 |
| 2.2.2 | Installing the AlphaCom XE7 cabinet..... | 9 |
| 2.2.3 | Installing the AlphaCom XE20 cabinet..... | 10 |
| 2.2.4 | Installing the AlphaCom XE26 cabinet..... | 10 |
| 2.2.5 | LCM - Line Connection Module | 11 |
| 2.2.6 | Installing feature boards | 11 |
| 2.2.7 | AMC-IP - AlphaCom Module Controller Board..... | 12 |
| 2.2.8 | APC - Program and Clock Board..... | 13 |
| 2.2.9 | ASLT - Subscriber Line Board | 13 |
| 2.2.10 | ATLB - Telephone Line Board | 14 |
| 2.2.11 | ATLB-12 - Telephone Line Board..... | 15 |
| 2.2.12 | AGA - General Purpose Audio Interface | 16 |
| 2.3 | Performing a Cold Start | 16 |
| 2.3.1 | Cold start procedure | 16 |
| 2.3.2 | Cold start AMC application only (retain IP setting)..... | 17 |
| 2.4 | Modifying Factory Default Settings | 17 |
| 2.5 | Default Directory and Feature Numbers | 17 |
| 2.5.1 | Station numbers..... | 17 |
| 2.5.2 | Class of Service (CoS)..... | 17 |
| 2.5.3 | Features during connection | 18 |
| 2.5.4 | Voice and display messages | 18 |
| 2.5.5 | Station functions | 19 |
| 2.5.6 | System maintenance | 20 |
| 2.5.7 | Control room stations..... | 20 |
| 2.5.8 | Mail queue navigation..... | 21 |
| 2.5.9 | Dual Display station | 21 |
| 2.5.10 | Telephone functions..... | 21 |
| 2.5.11 | AlphaNet | 21 |
| 3 | AlphaWeb XE | 22 |
| 3.1 | Connecting to AlphaCom using AlphaWeb | 22 |
| 3.1.1 | Saving and applying changes..... | 23 |
| 3.2 | Changing Default User Name and Password | 23 |
| 3.3 | Installing License Keys | 24 |
| 3.4 | IP Configuration | 24 |
| 3.4.1 | Overview | 24 |
| 3.4.2 | IP interfaces | 24 |
| 3.4.3 | Configure IP routing | 25 |
| 3.4.4 | Internal firewall..... | 25 |
| 4 | AlphaPro | 26 |
| 4.1 | Overview | 26 |
| 4.1.1 | AlphaPro versions..... | 26 |
| 4.1.2 | Backwards compatibility..... | 26 |

| | | |
|----------|---|-----------|
| 4.1.3 | PC requirements | 27 |
| 4.2 | Getting Started with AlphaPro..... | 27 |
| 4.2.1 | PC setup | 27 |
| 4.2.2 | Insert the HW dongle | 27 |
| 4.2.3 | Connect a PC to the server | 27 |
| 4.3 | Defining Network and Exchange..... | 28 |
| 4.3.1 | Initial programming | 28 |
| 4.3.2 | Add network or exchange | 28 |
| 4.4 | Data Communication | 29 |
| 4.4.1 | Establishing data communication | 29 |
| 4.4.2 | Send information to the exchange | 29 |
| 4.4.3 | Get information from the exchange | 29 |
| 4.5 | Communication Window Actions..... | 29 |
| 4.6 | AlphaPro Menu Structure..... | 30 |
| 5 | Station Configuration | 32 |
| 5.1 | Configuration in AlphaPro | 32 |
| 5.2 | Additional IP and SIP Station Configuration | 34 |
| 5.3 | IP DECT SIP Station Configuration..... | 34 |
| 6 | AlphaNet | 35 |
| 6.1 | Overview | 35 |
| 6.2 | VoIP AlphaNet Configuration | 36 |
| 6.2.1 | Overview | 36 |
| 6.2.2 | Insert AlphaNet license | 36 |
| 6.2.3 | Create all the exchanges in the AlphaNet..... | 36 |
| 6.2.4 | Create AlphaNet data routing | 36 |
| 6.2.5 | Create AlphaNet audio channels | 38 |
| 6.2.6 | Cluster node programming | 38 |
| 6.2.7 | Update the directory in each exchange | 39 |
| 7 | Multi-Module Network..... | 41 |
| 7.1 | Overview | 41 |
| 7.2 | Installation | 41 |
| 8 | External Communication..... | 43 |
| 8.1 | SIP Trunk License..... | 43 |
| 8.2 | Gateway Configuration | 43 |
| 8.3 | AlphaCom Configurations | 43 |
| 8.3.1 | AlphaWeb Configurations | 43 |
| 8.3.2 | Insert SIP Trunk licenses | 44 |
| 8.3.3 | Firewall (filter) settings | 44 |
| 8.4 | AlphaPro Configuration | 44 |
| 8.4.1 | Create a SIP Trunk Node | 44 |
| 8.4.2 | Define the AlphaCom/SIP routing | 44 |
| 8.4.3 | Create Prefix number..... | 45 |
| 8.4.4 | Update the exchange..... | 45 |
| 8.5 | Billing System | 45 |
| 9 | Audio Messaging | 47 |
| 9.1 | Stored Voice Messages | 47 |
| 9.1.1 | Message identification | 48 |
| 9.1.2 | ASVP software module | 48 |
| 9.1.3 | ASVP board | 48 |
| 9.2 | Customized Message Upload..... | 49 |
| 9.2.1 | Upload messages from AlphaWeb..... | 49 |

| | | |
|-----------|--|-----------|
| 9.2.2 | Record message from a station | 51 |
| 9.2.3 | Licensing | 51 |
| 9.2.4 | Supported audio file formats | 52 |
| 9.3 | Recall | 52 |
| 9.3.1 | Directory numbers | 52 |
| 9.3.2 | User interface | 53 |
| 9.3.3 | Optional settings | 53 |
| 9.3.4 | Simultaneous recall operations | 54 |
| 9.3.5 | Hardware and software requirements | 54 |
| 9.4 | Auto-attendant | 54 |
| 9.4.1 | Configuration | 55 |
| 9.4.2 | Hardware and license requirements | 56 |
| 10 | System Monitoring..... | 57 |
| 10.1 | System Logging | 57 |
| 10.1.1 | Local log file and AlphaWeb..... | 58 |
| 10.1.2 | System clock and event time stamps | 59 |
| 10.2 | System Information and Statistics..... | 60 |
| 10.2.1 | SNMP MIBs | 60 |
| 10.2.2 | System information | 60 |
| 11 | Upgrade & Backup..... | 61 |
| 11.1 | Software Upgrade | 61 |
| 11.2 | Configuration Backup and Restore | 61 |
| 12 | Appendix - Technical Data | 62 |
| 12.1 | Specifications..... | 62 |
| 12.2 | Physical Numbers | 63 |
| 12.3 | ASLT & AGA Board Positions | 63 |
| 12.4 | Switches and Jumpers..... | 64 |
| 12.4.1 | AMC-IP | 64 |
| 12.5 | Port Pin-Out | 65 |
| 12.5.1 | RIO controller unit connection | 67 |

1 The AlphaCom XE System

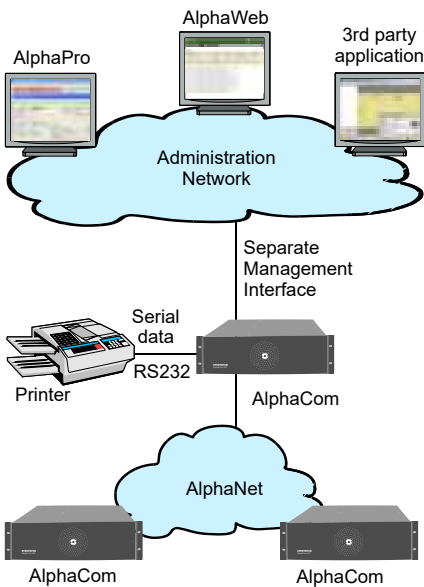

The AlphaCom XE Audio Server with HD Voice system provides easy to use, secure and powerful system management capabilities targeted towards meeting the needs and demands of the end-user.

The management system has an open and flexible architecture that caters to multiple tools and technologies.

The management tools and functions come with different levels of complexity, running the gamut from small standalone systems to large integrated management systems.

The main tools and functions are:

- AlphaPro
- AlphaWeb
- Logging and monitoring
- System upgrade and Backup
- Interface to 3rd party management tools

AlphaPro

AlphaPro is the professional tool for configuration of the AlphaCom XE system. It is self contained, simple to install and use. When a new server is to be configured, it is given a working default factory setting which may be modified later. AlphaPro works over IP or the local data port (RS232).

AlphaWeb

AlphaWeb is an embedded web server running on the AlphaCom XE server. It allows users to log in using a standard web browser such as Internet Explorer or Firefox to operate and manage the AlphaCom XE system.

Logging and monitoring

AlphaCom XE comes with powerful logging and monitoring functions, providing the user with good oversight of system status and events.

Software and system upgrade

AlphaCom XE comes with powerful software and system upgrade capabilities. New software packages are easily uploaded and stored to flash via AlphaWeb. In addition, older AlphaCom systems can be upgraded to AlphaCom XE with only limited hardware changes and automatic upload and conversion of the old customer database.

Interface to 3rd party management tools

AlphaCom XE has a wide range of open interfaces that supports integration with 3rd party management applications. The 3rd party management application may interface AlphaCom XE using SNMP (Simple Network Management Protocol), syslog, HTTP (Hyper Text Transfer Protocol), NTP (Network Time Protocol), and OPC (open connectivity via open standards), as well as legacy STENTOFON data protocols.

1.1 Flexible, Secure and Safe Operation

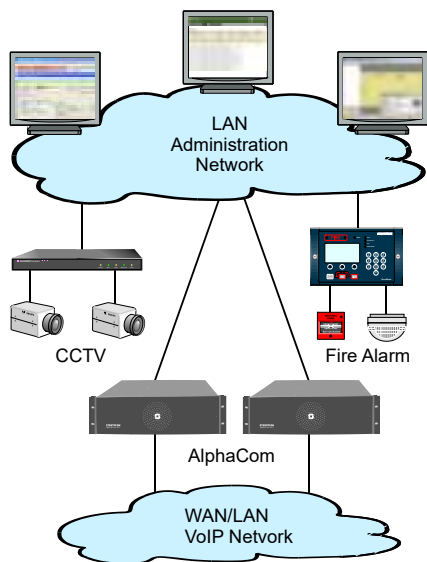

Critical Communication over IP (CCoIP®) is our solution for VoIP with IP services and applications integrating security and reliability functionalities required in critical situations. The critical communication solution can no longer be regarded as a totally independent system isolated from data networks and their associated challenges.

The AlphaCom system provides carrier class system availability and protects resources in an IP environment by using embedded IP security mechanisms. The main AlphaCom XE security mechanisms are:

- Restricted management access
- Separate management interface
- Internal firewall

1.1.1 Restricted management access

All users need to authenticate themselves before gaining access to management services. The authentication process uses an MD5 authentication routine.

1.1.2 Separate management interface

AlphaCom XE comes with a separate Ethernet interface which can be dedicated to management. This allows the administrator to build a separate administration VLAN that is dedicated only to administrators.

1.1.3 Internal firewall

AlphaCom XE has an internal firewall allowing the network administrator to open and close IP services that are allowed access to AlphaCom XE from the different networks.

AlphaCom XE comes with the most restrictive firewall settings by default.

To change these settings, log into AlphaWeb as described in section 3.1.

- Select **System Configuration > Filters**

2 Getting Started

This section is a step-by-step guide to getting the AlphaCom XE system up and running.

1. Sketch a network overview
2. Unpack and install hardware
3. Perform cold start
4. Connect to AlphaWeb
5. Configure IP Settings
6. Change default user name and password
7. Enter the license key
8. Modify default settings (optional)
9. Perform a system backup

The AlphaCom XE servers are shipped with a default factory setting and the system will work straight out of the box. If no changes to the default factory settings are required, it is enough to perform steps 1 to 6 to set up a working system.

Some changes to the default factory settings are often required, for instance if the default numbering plan and naming in the directory shall be updated to reflect the floors in a building, then the optional steps should also be performed.

2.1 Making a Network Plan

Make a plan of the network topology as shown in the example below.

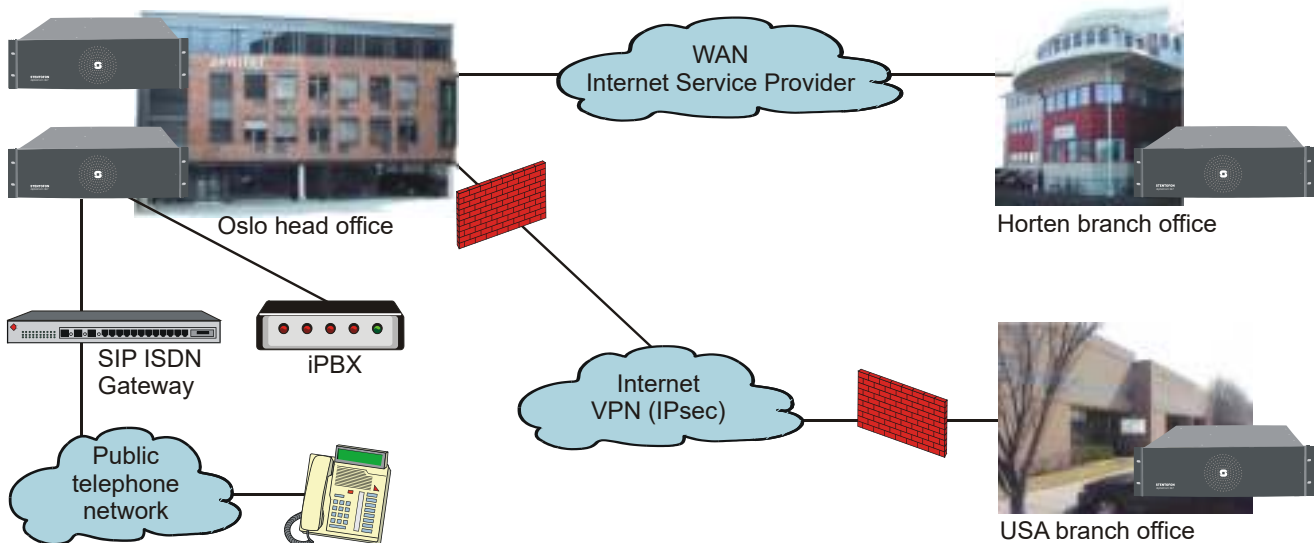

| LAN Oslo | |
|------------------|---------------|
| Network IP | 10.0.1.0 |
| Mask | 255.255.255.0 |
| Router Oslo | 10.0.1.1 |
| AlphaCom Oslo 1 | 10.0.1.10 |
| AlphaCom Oslo 2 | 10.0.1.11 |
| iPBX | 10.0.1.20 |
| SIP ISDN Gateway | 10.0.1.21 |

| LAN Horten | |
|-------------------|---------------|
| Network IP | 10.0.5.0 |
| Mask | 255.255.255.0 |
| Router Horten | 10.0.5.1 |
| AlphaCom Horten 1 | 10.0.5.10 |
| | |

| LAN USA | |
|----------------|---------------|
| Network IP | 10.0.10.0 |
| Mask | 255.255.255.0 |
| Router USA | 10.0.10.1 |
| AlphaCom USA 1 | 10.0.10.10 |
| | |

2.2 Unpacking and Installing Hardware

Remove all hardware from the packing boxes and inspect each item to ensure that they have not been damaged during shipping. In addition, check that the packing boxes contain all the items you ordered. If you discover or suspect any damage, contact your distributor immediately.

2.2.1 Installing the AlphaCom XE1 cabinet

More information is found in Datasheet A100K10798

The cabinet should be mounted on a shelf or in a 19" rack. It contains one AMC-IP processor board only. The server includes a power board.



- All cables are terminated to connectors at the rear of the cabinet.
- Two RJ-45 Ethernet terminals are used for IP LAN, WAN, Internet and AlphaNet IP communication.
- The serial ports with RS232 and RS422 interfaces are used for connecting to equipment using these protocols.
- The unit is powered from a 90-240 VAC via a 5 VDC power supply.

2.2.2 Installing the AlphaCom XE7 cabinet

More information is found in Datasheet A100K10799

The cabinet can be wall or shelf mounted or mounted in a 19" rack. It has room for installation of one AMC-IP processor board and up to 6 feature boards. The server also includes a power board and a cooling fan.



- All cables are terminated to connectors on the backplane.
- The two-pair star wired intercom cables are connected using pluggable screw connectors.
- Two RJ45 Ethernet terminals are used for IP LAN, WAN, Internet and AlphaNet IP communication.
- The serial ports with RS232 and RS422/485 interfaces are used for connecting to equipment using these protocols.
- The two NO switches on the RCI connectors can execute programmable functions.
- The 12 RCOs are connected to optional MRBD relay boards and can be programmed to execute functions such as door control.
- Connectors 5 and 6 on the first ASLT line board are enabled for program distribution. Additional programs can also be connected to individual ASLT ports via the interface board FBSAR, with 6 programs per board. If line points 5 and/or 6 are to be used as subscriber line points, follow the connection procedure for AlphaCom XE7 in section 2.2.9.
- The server is normally powered from the mains via a 24 VAC transformer. The 6 A type 203 0010 260 can serve up to 24 subscribers, while the 11 A type 203 0010 270 is needed for a full cabinet of 36 subscribers.
- Battery backup power is connected to the 24 VDC input plug.
- The ground terminal is connected to the cabinet. The jumper is used to provide galvanic connection between the cabinet and 0V (DC-GND) or isolation from 0V (AC-GND). AC-GND is only used on marine vessels.

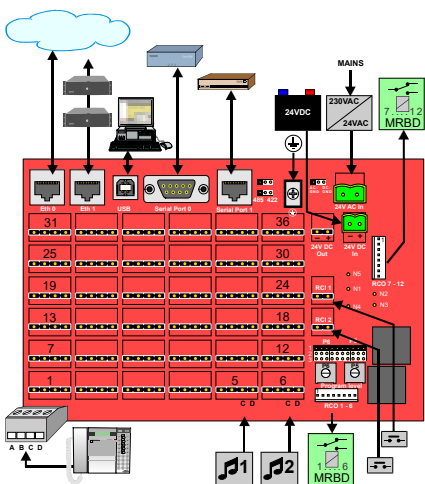



2.2.3 Installing the AlphaCom XE20 cabinet

More information is found in Datasheet A100K10800.

The cabinet is intended for mounting in a 19" rack. It has room for installation of 20 circuit boards in total: one AMC-IP processor board, one APC program & clock board, and up to 18 feature boards. The server also includes a mains power supply.

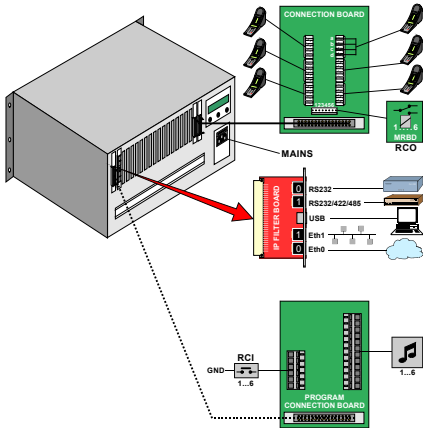

- Up to 4 units may be mounted in one 19" rack if sufficient ventilation is provided. It is recommended to mount a 24 VDC cooling fan module on top of each server unit.
- The two-pair star wired intercom cables are connected to connection boards or an LCM Line Connection Module on the cabinet DIN rail or in a separate distribution field.
- Each subscriber line card provides 6 freely programmable Remote Control Outputs (RCOs).
- Two RJ45 Ethernet terminals on the IP filter board are used for IP LAN and WAN communication.
- The serial ports with RS232 and RS422/485 interface are used for connecting to equipment using these protocols.
- 6 program distribution sources can be connected to the APC board via an optional program connection board or to an LCM Line Connection Module. Up to 64 extra programs may be added using AGA boards with 16 programs per board.
- The optional program connection board or LCM module has input for 6 Remote Control Inputs (RCIs) which can initiate programmed actions.
- The server is powered from the mains. The power supply, APWR, runs on 90-270 VAC.
See the manual *A110K10610 Line Connection Module* for details.

2.2.4 Installing the AlphaCom XE26 cabinet

More information is found in Datasheet A100K10317.

There are three standard cabinet models: 19" rack mounting, floor cabinet, and floor cabinet with distribution field.

The cabinet has room for installation of 26 circuit boards in total: one AMC-IP processor board, one APC program & clock board, and up to 24 feature boards. The server also includes a mains power supply and a cooling fan.

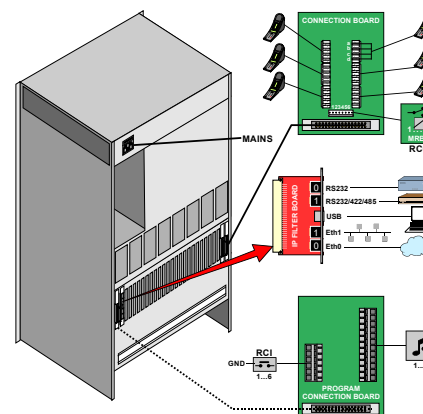

- The two-pair star wired intercom cables are connected to connection boards or LCM Line Connection Modules.
- There is one Remote Control Output (RCO) per subscriber point on the connection board which can be programmed to perform actions via an optional relay board. The LCM module has relay output for 6 RCOs while additional RCOs require optional relay boards.
- Two RJ45 Ethernet terminals on the IP filter board are used for IP LAN and WAN communication.
- The serial ports with RS232 and RS422/RS485 interfaces are used for connecting to equipment using these protocols.
- 6 program distribution sources can be connected to the APC board via an optional program connection board or an LCM Line Connection Module. Up to 64 extra programs may be added using AGA boards, with 16 programs per board.
- The optional program connection board or LCM module has input for 6 Remote Control Inputs (RCIs) which can initiate programmed actions.
- The server is powered from the mains. The power supply, APWR, runs on 90-270 VAC.

2.2.5 LCM - Line Connection Module

See the manual *A110K10610 Line Connection Module* for more details.

The Line Connection Module (LCM) is used for external connections for AlphaCom XE servers with any mix of ASLT, ATLB and ATLB12 boards. LCM is not used with XE1 and normally not used with XE7 as this server has line connections on the backplane.

One module serves 6 subscriber boards (36 intercom stations). Up to 4 modules may be needed in a fully equipped XE26 server.

The module(s) must be mounted to DIN rail(s) on the server termination field and connected to the server according to the project configuration.

The LCM board will substitute

- 6 x Subscriber Connection boards (100 9930 200)
- Power Distribution board (100 9970 101)
- MRBD, Relay board with 6 RCO relays (100 9970 200)
- FBSAR, Filter and Speech Adapter board with 2 audio outputs, 1 audio input and PTT relay if these functions are used. (100 9505 000)

Each LCM board has connectors for

- **24 VDC Power**
 - Input
 - Output
 - 3 x fused outputs
 - 6 x fused relay controlled RCO outputs (switch selection)
- **Line-points**

All subscriber line connections are made to the LCM board. Any mix of ASLT, ATLB and ATLB-12 boards may be used.

 - Max. 36 analog intercom stations with 6 x ASLT boards
 - Max. 72 analog telephone lines with 6 X ATLB-12 boards
- **RCO**
 - 6 x relay contacts, potential-free or +24 V (switch selection)
 - 6 x output to optional MRBD Relay board
- **RCI** ¹⁾
 - 6 x closing contact inputs referred to 0 V.
- **Audio program inputs** ¹⁾
 - 6 x galvanic isolated 600 ohm, 0 dB lines
- **Radio / Walkie-Talkie interface** ¹⁾
 - Galvanic isolated adjustable audio in and out
 - RCO relay can be used for PTT control
- **PA audio output**
 - Audio output for PA with monitor intercom station in parallel

¹⁾ The APC board must be connected to Line board connector 6. Not used in AlphaCom XE7

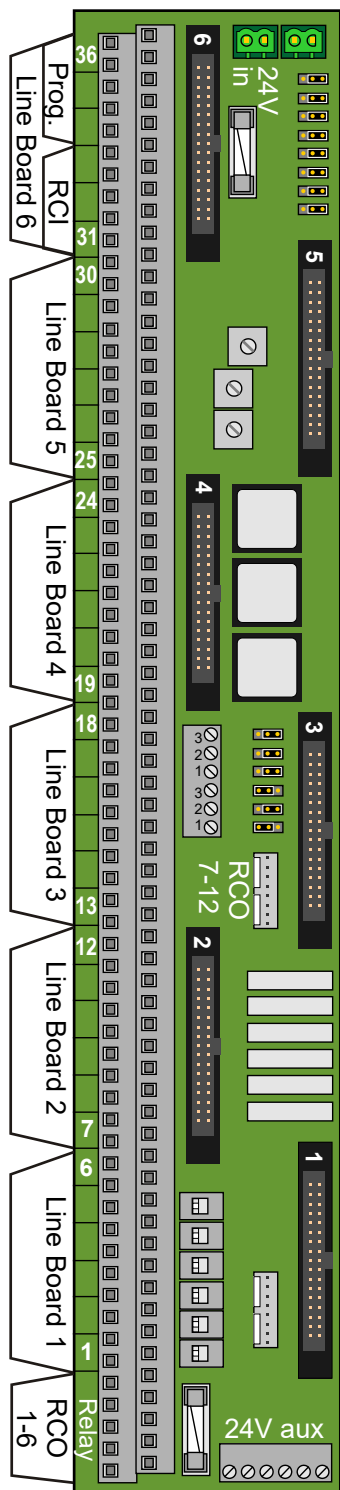

2.2.6 Installing feature boards

The AlphaCom XE servers, except XE1, have room for a number of feature boards. When using special feature boards, the maximum number of ASLT boards is reduced accordingly.

| BOARDS | | | BOARD POSITION | | | | | |
|--------|------------|-----------|----------------|----------|---------|----------|---------|----------|
| Type | Board Name | Reference | XE7 | | XE20 | | XE26 | |
| | | | Default | Possible | Default | Possible | Default | Possible |
| | | | | | | | | |

| | | | | | | | | |
|---------|-------------------------------|--------------|-----|-----|---------|---------|-------|-------|
| APC | Program and Clock | 100 9301 000 | - | - | 26 | - | 26 | - |
| AMC-IP | AlphaCom Module Controller | 100 9202 100 | 7 | - | 25 | - | 25 | - |
| ASLT | Subscriber Line | 100 9101 010 | 1-6 | - | 1, 8-23 | | 1-19 | 20-23 |
| ATLB | Telephone Line - 6 lines | 100 9102 000 | 2 | 1-6 | 1, 8-23 | | 1-19 | 20-23 |
| ATLB-12 | Telephone Line - 12 lines | 100 9104 000 | 2 | 1-6 | 1, 8-23 | | 1-19 | 20-23 |
| AGA | Audio Interface, program feed | 100 9303 001 | 1-6 | | 18-21 | | 18-21 | |
| | As station | | 1-6 | | 20-23 | 1, 8-19 | 20-23 | 1-19 |

Hot-plug

In XE20 and XE26 servers, all boards may be inserted or removed without switching off the power by inserting the powered RJ-11 plug from the APC board in the hot-plug receptor found at the top of all cards

- Remove the hot-plug when the board is in place.

In an XE7 server, the power must be switched off prior to removal or insertion of boards as this server does not have the APC board or hot-plug feature.

① ***It is strongly recommended to wear a grounded wrist-strap when handling electronic boards to avoid electrostatic discharges that may seriously damage the electronic circuits!***

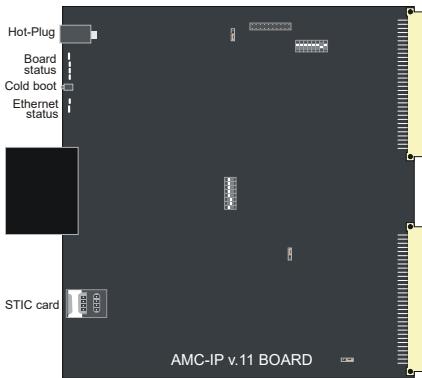
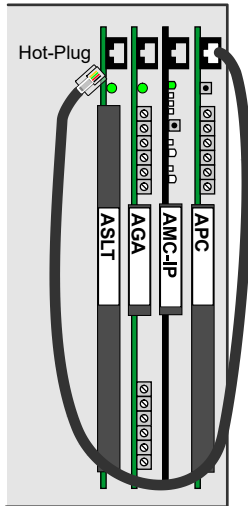

2.2.7 AMC-IP - AlphaCom Module Controller Board

All AlphaCom servers in the XE series have one AMC-IP v.11 board delivered at shipment.

The AMC-IP v.11 board is the next generation multi-service board developed for the STENTOFON AlphaCom XE series. The board is made for critical communication and security solutions featuring an embedded real-time Linux operating system, integrated media processing engine, packet processing engine, HW encryption, and storage module.

The AMC-IP board provides full backwards compatibility for both software and hardware. All traditional AlphaCom services and interfaces are supported. The board can support traditional AlphaCom feature boards and cabinets.

STIC

The STENTOFON Identity Card (STIC) is the logical identity of the AMC-IP board. The STIC contains the unique network identifier and network settings for the AMC-IP board, making it possible to replace the AMC-IP with just a simple restore operation.

The AMC-IP board comes with a SIM-sized card holder for the STIC. When delivered, the STIC resides within a regular credit card-sized card. Detach the smaller STIC by gently pressing it out. Keep the remaining part of the card as the MAC address programmed in the STIC is printed on it.

There are different STICs for XE1/XE7 and XE20/XE26 servers.



3.3V Battery

The AMC-IP board features an on-board coin cell battery of type CR2032. The battery is used for backing up the on-board RAM as well as keeping the real-time clock running when the board is powered down.

① ***CAUTION: Risk of explosion if incorrect type of battery is used. Follow instructions for proper disposal of used batteries.***

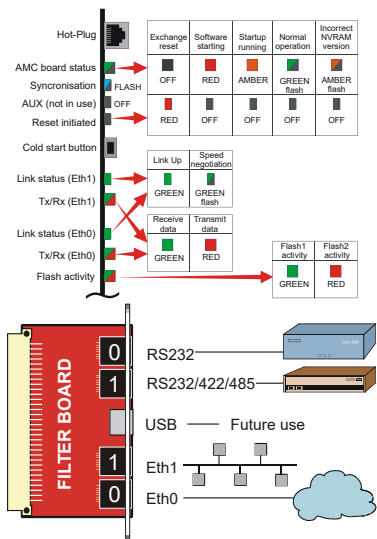

Indicators

The card has a number of LEDs to indicate the board and Ethernet status.

See section 12.4.1 for other possible Ethernet LED indications.

Filter board

A filter and connection board, FBIP, must be inserted from the rear side of the cabinet in the same card position as the AMC-IP card. This filter board is not needed in AlphaCom XE1 or XE7 where all EMC filters and external connectors are integrated in the backplane.

The USB connector is not supported in AMC-IP board 11 versions.

2.2.8 APC - Program and Clock Board

The APC Board is used in AlphaCom XE20 and XE26 to control the backplane board clocking. It also controls the speed of the fans. This board must be installed in position 26.

It contains circuitry for 6 audio program feed channels with galvanic isolation. Each channel has separate input level controls.

The card has 6 RCI alarm inputs which can be used for programmed actions. The inputs accept a closing contact referred to ground.

A reset button is used to reset and restart the entire server. The reset LED on the AMC-IP board will turn red during reset.

An APC connection kit 100 9503 000 needs to be purchased to connect alarm and audio sources. The kit contains a filter board, a connection board, and an interface cable.

Further information is found in datasheet A100K10011.

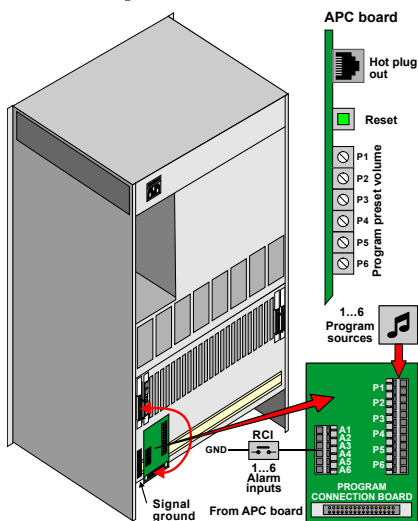

2.2.9 ASLT - Subscriber Line Board

Two boards for 12 intercom subscribers are normally delivered with the server. The maximum number of cards in one server is:

- AlphaCom XE7: 6 in positions 1-6
- AlphaCom XE20: 17 in positions 1, 8-23
- AlphaCom XE26: 23 in positions 1-23

Each board contains circuitry for 6 subscriber connections and one measurement channel for voice switching control.

The board provides 6 remote control software controlled outputs. The line monitoring reports errors on all subscriber lines.

AlphaCom XE20/XE26

Intercom stations and control outputs are connected to a connection board mounted on the server connection field.

2 subscriber connection boards (100 9930 200) with 1.5 m connection cables (100 9501 011) are delivered with the servers.

5 m (100 9501 021) and 10 m (100 9501 023) subscriber connection cables with filter boards can be purchased separately if the distribution field is placed away from the server. These cables have a D-sub connector for the filter board and unterminated wires for the distribution field. Color code is packed with the cables.

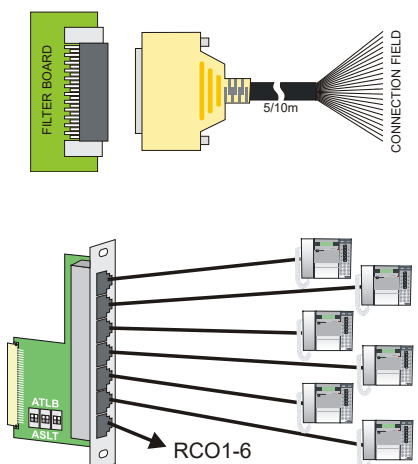
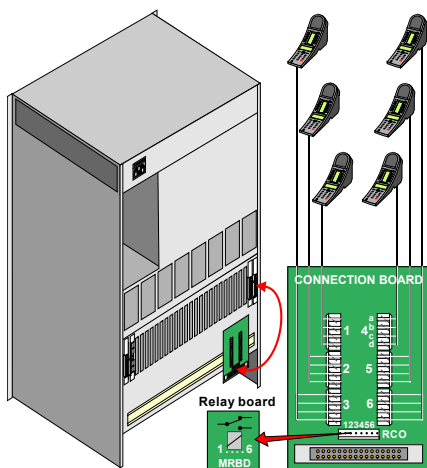

Filter card with RJ connectors

This board (100 9501 041) has RJ45 connectors for connection of 6 CAT5 installation cables to the back of the server. Station cables can be plugged directly to this card. The 7th RJ45 outlet is for 6 RCOs.

The board can be used for ASLT and ATLB/ATLB-12 cards selected by DIP switches. Switch Down is ASLT and Switch Up is ATLB or ATLB-12

| RJ45 pin no. | ASLT | ATLB | ATLB-12 | RCO |
|--------------|------|------|---------|-----|
| 1 | | | | 1 |
| 2 | | | | 2 |
| 3 | a | | a1 | 3 |
| 4 | | a | | 4 |
| 5 | | b | | 5 |
| 6 | b | | b1 | 6 |
| 7 | c | | a2 | GND |
| 8 | d | | b2 | GND |

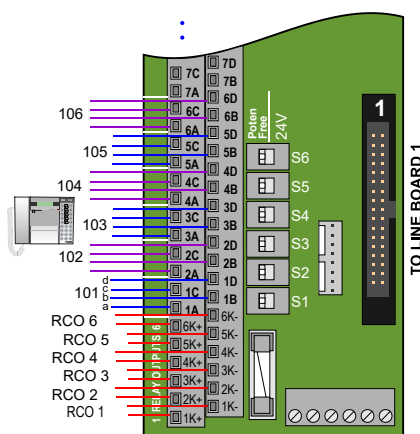
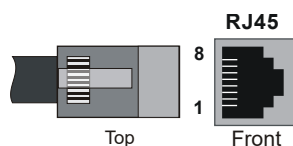

Connection to LCM

The ASLT Subscriber Line boards are connected to the LCM via 1.5 m connection cables (100 9501 011), one for each board.

Stations are connected to the terminal strip in the following order: the first station on Line Board 1 to the terminals marked 1A, B, C, D, the next to 2A, B, C, D and so on. Stations on Line Board 2 starts at terminal 7.

RCOs are taken from Line Board 1 and are available on terminals marked 1K+/- to 6K+/-.

RCO function is set via the switches S1 to S6.

- **Poten Free** Potential-free closing contacts, max. 250 VAC, 5 A
- **24V** Fused internal 24VDC, max. 1 A

AlphaCom XE7

All intercom stations are connected by means of pluggable screw terminals on the server backplane.

Line points 5 and 6 are, by default, used as program distribution inputs on line c-d when an ASLT board is inserted in board position 1.

- The jumpers P5 and P6 are set to positions 2-3.
- The potentiometers P5 and P6 are used to adjust the input level.

Line points 5 and 6 can also be used as normal subscriber points

- Set jumpers 5 and 6 to positions 1-2
- In AlphaPro, select **Exchange & System > Board**
- Change the port setting from **Audio Program Feed** to **Default**
- Reset the exchange

RCOs 1-6 are associated with the board in position 1 and RCOs 7-12 in position 2. See also datasheet A100K10315.

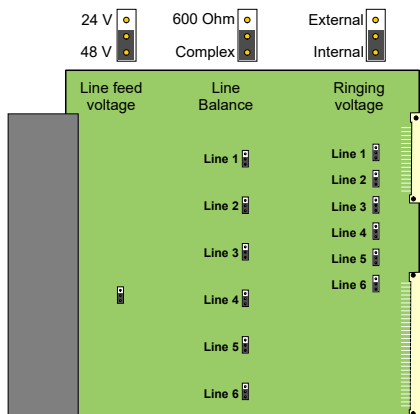
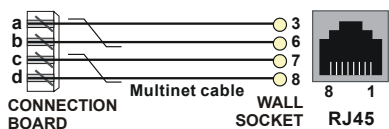
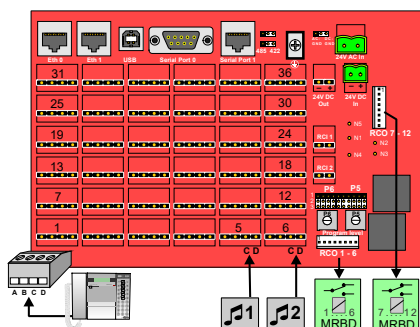

Cabling

Desktop stations are connected to the line on RJ45 wall sockets.

Further information on the ASLT board is found in datasheet A100K10012.

2.2.10 ATLB - Telephone Line Board

The ATLB board contains circuitry for connecting 6 two-wire DTMF telephones used as AlphaCom subscribers. The board also provides one measurement channel for voice switching control.

They plug into any positions 1-23 in the XE20 and XE26 servers and positions 1-6 in the XE7 substituting ASLT boards.

A hot-line function can be activated: a pre-programmed number is then dialed when the handset is lifted. Another number is dialed when the handset is replaced.

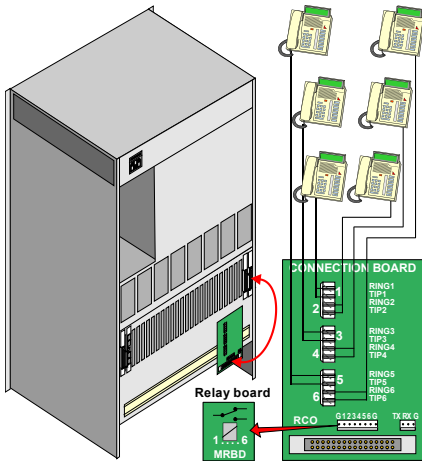

The board provides 6 remote control software controlled outputs.

The line monitoring option requires a 10K resistor across the line at the telephone end. The monitoring reports errors on all subscriber lines. If the handset is left off-hook for 1 hour (programmable timer), a line error is reported.

There are jumpers on the board to select options. The default settings should normally not be changed.

- Line feed voltage
 - 48 V Default, normally used
 - 24 V Short distance or special 24 V phones
- Ringing voltage for each station
 - Internal Default, for indoor or office environment
 - External For outdoor or industrial environments or for many telephones on one line
- Line balance
 - Complex Default, normal in most countries
 - 600 ohm Best in some countries, may reduce feedback in handset

AlphaCom XE20/XE26

Telephones and control outputs are connected to a connection board mounted on the server connection field.

Telephone connection boards with transient protection (100 9930 202) and subscriber connection cables with filter board (100 9501 031) must be purchased separately.

Telephones may also be connected to an LCM board (100 9950 100). This board is likely to be installed in XE servers with DTMF telephones due to the expanded capacity. The default DIP switch settings should normally not be changed.

The first and last three connector pairs on each board shall not be used.

AlphaCom XE7

All telephones are connected by means of pluggable screw terminals on the server backplane.

The ALTB board can be placed in any board position 1-6. The example drawing shows an ALTB board in position 2. If possible, avoid using boards in position 1 as connection points 5 and 6 are used for program input by default.

Further information on the ALTB board is found in datasheet A100K10237.

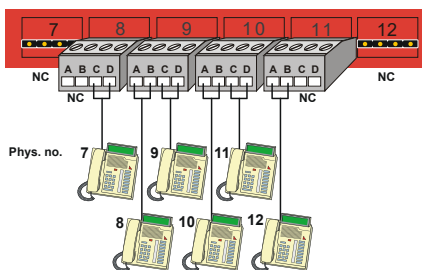
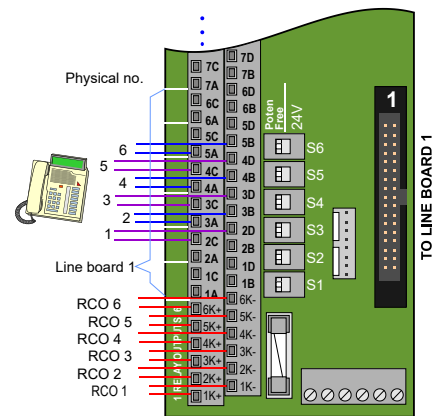

2.2.11 ATLB-12 - Telephone Line Board

ATLB-12 has the same functions as ATLB except that it has 12 two-wire DTMF telephone lines. ATLB-12 does not support line monitoring.

The 6 first telephones get the physical number according to the card's physical slot and the last 6 telephones have numbers with an offset of +276 to the 6 first physical numbers.

This board is likely to be installed in XE servers with DTMF telephones due to the expanded capacity.

The default DIP switch settings should normally not be changed.

See separate LCM documentation for more information.

AlphaCom XE20/XE26

The ATLB-12 boards are connected to the LCM via 1.5 m (100 9501 011) or 3.0 m (100 9501 014) connection cables, one for each board.

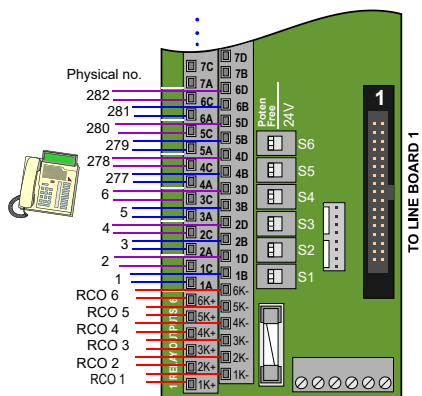

Stations are connected to the terminal strip, the first telephone on Line Board 1 to the terminals marked 1A, B, the next to 1C, D and so on. Telephones on Line Board 2 starts at terminal 7.

RCOs are taken from Line Board 1 and are available on terminals marked 1K+/- to 6K+/-.

RCO function is set by the switches S1 to S6.

- **Poten Free** Potential-free closing contacts, max. 250 VAC, 5 A
- **24V** Fused internal 24VDC, max. 1 A

Telephones may also be connected to connection boards 100 9930 202 - two connection boards are needed per ATLB-12 board.

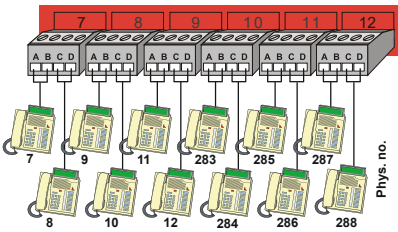

AlphaCom XE7

All telephones are connected by means of pluggable screw terminals on the server backplane.

The ALTB-12 board can be placed in any board positions 1-6. The example drawing shows an ATLB-12 board in position 2. Avoid using boards in position 1 if possible as connection points 5 and 6 are reserved for program input by default.

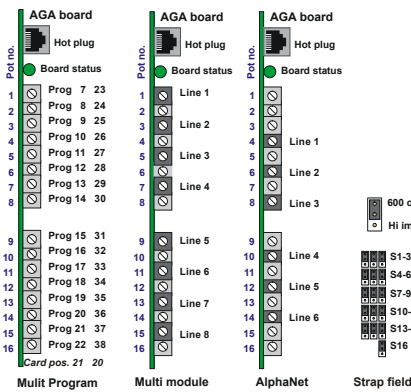

2.2.12 AGA - General Purpose Audio Interface

The AGA board is a multi-purpose audio interface board used for program feeding or speech communication between modules. There are easily accessible potentiometers at the front for input sensitivity control of the audio channels.

The impedance can be set to 600 ohm or 'high' for each input by strap switches on the board.

Further information on the AGA board is found in datasheet A100K10182.

Multi program distribution

Each board provides 16 audio inputs for program distribution when used in AlphaCom XE20 or XE26. There can be 1 to 4 boards in a module placed in positions 18 to 21.

An AGA connection kit, 100 9930 300, has to be purchased to connect the audio sources. The kit contains a filter board, a connection board, and an interface cable.

AGA boards can be placed in board positions 1-6 in an XE7 server but the number of inputs are reduced to 6 per board. Input adjustments are performed by potentiometers 4, 6, 8, 10, 12 and 14. The program sources are connected to the c and d terminals on backplane connectors.

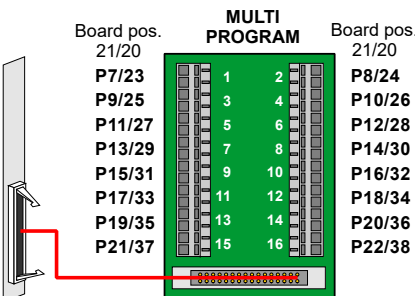

Audio distribution in AlphaNet

Each board provides 6 audio channels between the servers.

There can be any number of AGA boards in each server placed in any position. Positions 20-23 are recommended in XE26 to avoid modifications of the backplane.

Use the same filter board with cable and connection board as ASLT.

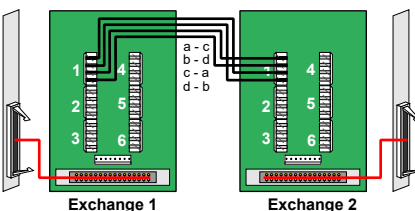

2.3 Performing a Cold Start

A cold start of the AMC-IP board will delete all previous programming, load the default database and set the default IP address to 169.254.1.5 with mask 255.255.0.0 on Eth0. See section 3.4 for default settings.

2.3.1 Cold start procedure

- Turn the server mains switch ON (at the rear of the cabinet).

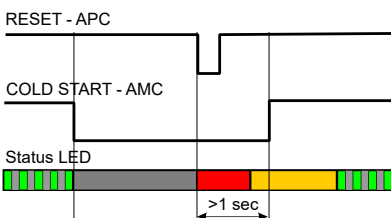

- Press and hold the cold start button on the AMC-IP board.
- Press the reset button on the APC card briefly.
 - XE7: the reset button is located on the power card
 - XE1: Power up while keeping the cold start button pressed.
- Keep the cold start button pressed at least 1 second after reset.
 - The AMC status LED will blink green when the boot is ready.

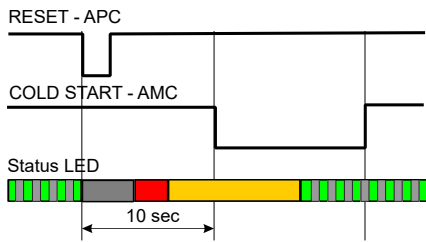

2.3.2 Cold start AMC application only (retain IP setting)

- Press the reset button on the APC card briefly.
 - XE7: the reset button is located on the power card
 - XE1: Power up while keeping the cold start button pressed.
- After 10 seconds, press the cold start button on the AMC-IP board.
- Keep the cold start button pressed until the AMC running LED blinks green.

2.4 Modifying Factory Default Settings

The system is set up with a default program and works without any further programming. To change or add to the default settings, the AlphaPro programming tool must be used - see section 5.

Perform System Backup if any default setting has been changed - see section 12. The default parameters are restored by performing a cold start - see section 2.3.

2.5 Default Directory and Feature Numbers

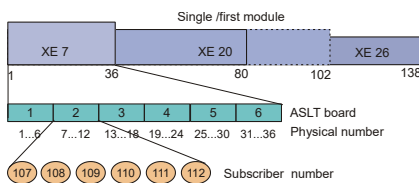

2.5.1 Station numbers

The number series 101 to 499 and 5000 to 5152 are default directory numbers for all AlphaCom XE servers. The directory numbers are connected to physical numbers in the range from 1 to 552, where the physical numbers are given by the subscriber point on a board in a certain position in a defined module.

Since the card positions 2-7 are not used in XE20, the corresponding default subscriber numbers are missing.

The directory numbers can be changed by using the AlphaPro programming tool.

| ANALOG STATION NUMBER TABLE | | | |
|-----------------------------|----------------------------|---------------------------------------|--------------------------|
| AlphaCom modules | XE7 | XE20 | XE26 |
| Single or master | 101 - 136 | 101 - 106 143 - 238 | 101 - 238 |
| 1 st slave* | 239 - 274 | 239 - 244 281 - 376 | 239 - 376 |
| 2 nd slave* | 377 - 413 | 377 - 382 419 - 499 5000 - 5014 | 377 - 499 5000 - 5014 |
| 3 rd slave* | 5015 - 5051 | 5015 - 5020 5057 - 5152 | 5015 - 5152 |
| Display text | Station 1, Station 2, etc. | | |

2.5.2 Class of Service (CoS)

A Class of Service defines a set of features available for a station. There are 16 freely programmable classes where three are pre-defined during setup. All stations are normally in the CoS1 group.

CoS1: Regular stations.

CoS15: Public telephone lines (SIP trunk)

* Slave modules are only required for analog stations. IP stations are always registered to the master module.

CoS16: Includes all features by default, dedicated to Super User on physical number 1.

2.5.3 Features during connection

A number of features can be utilized during conversation and each of these have their own code number.

| CODES DURING CONVERSATION | | | | | | | |
|-------------------------------|-----|------|-------|-----------------------------------|-----|------|-------|
| Feature | No. | CoS1 | CoS15 | Feature | No. | CoS1 | CoS15 |
| Microphone mute | 0 | X | | Read own message remotely | 51 | X | X |
| Step directory menu | 0 | X | | Call Back message to own station | 55 | X | |
| Repeat absence message | 1 | X | X | Include in Open Duplex Conference | 56 | X | |
| Inquiry Call / Broker | 2 | X | X | Busy Notify | 57 | X | X |
| Call Transfer | 3 | X | | Busy Override | 58 | | |
| Pocket Pager default, no text | 44 | X | | Private and Absence Override | 59 | | |
| Pocket Paging with answer | 45 | X | X | Remote Control (Door opening) | 6 | X | |
| Pocket Paging, text message | 46 | X | X | Send standard voice message | 7 | X | X |
| Pocket Paging, voice message | 47 | X | X | Call Back | 8 | X | |
| Change message remotely | 50 | X | X | Search | 9 | X | X |



2.5.4 Voice and display messages

When the station is idle, entering a digit/number code will show different menus on the station display. Navigation in the menus is done using the 7, 8, and 9 keys.

| DISPLAY MENUS | | | |
|--------------------|-----|------|-------|
| Feature | No. | CoS1 | CoS15 |
| Info Service | 60 | X | |
| Group Call menu | 610 | X | |
| Absent menu | 611 | X | |
| Message menu | 612 | X | |
| Audio Program menu | 613 | X | |
| Name directory | 614 | X | |
| Features menu | 615 | X | |
| Service menu | 616 | X | |
| Conference menu | 618 | X | |

After a cold start *Info Service* (60) is available on DAK 9 and *Person Directory* (614) is available on DAK 10.

Messages are given as a text string in the display. A spoken message is given if the voice module ASVP is installed.

Leave pre-recorded standard messages by dialing the extension number + 7 + message code. Listen to and reset message by code number 70.

Absence messages are left in your own idle station by dialing the message code number. Add digits for date or time if prompted.

| STANDARD MESSAGES (VOICE/DISPLAY) | | | | ABSENCE MESSAGES (VOICE/DISPLAY) | | | |
|-----------------------------------|-----|------|-------|----------------------------------|-----|------|-------|
| Feature | No. | CoS1 | CoS15 | Feature | No. | CoS1 | CoS15 |
| Contact switchboard | 660 | X | | Out | 771 | X | |
| Call phone number | 661 | X | | Meeting | 772 | X | |
| Call home | 663 | X | | Gone for the day | 773 | X | |

| | | | | | | | |
|------------------|-----|---|--|---------------|-----|---|--|
| Call your spouse | 664 | X | | Absent today | 774 | X | |
| Call me back | 666 | X | | Busy | 775 | X | |
| Remember meeting | 667 | X | | Lunch | 776 | X | |
| Fax waiting | 668 | X | | On holiday | 777 | X | |
| Delivery to you | 669 | X | | Away | 778 | X | |
| | | | | Not available | 779 | X | |

The Multi Conference Station (MCS) is no longer produced. The special feature numbers for this station is maintained for the sake of backwards compatibility.

2.5.5 Station functions

A number of features can be initiated from an idle station by dialing a default feature number. Some of these actions require a target subscriber number after the feature number.

It is recommended to program the most used features to single-touch keys for easy access.

| FUNCTIONS FROM IDLE STATION | | | | | | | |
|----------------------------------|----------|-------|--------|---------------------------------|------------|-------|--------|
| Feature | No. | CoS 1 | CoS 15 | Feature | No. | CoS 1 | CoS 15 |
| Delete message, clear station | 70 | X | X | GROUP CALL | | | |
| Call Forward | 71 | X | | All Call (all subscribers) | 84 | X | X |
| Follow Me | 72 | X | | Group Call 2-5 (empty) | 85-88 | X | X |
| Remote station reset | 73 | X | | Group Call 6-15 (empty) | 890-899 | X | X |
| Program single-touch key | 784 | X | | Recall to group 1-5 (84-88) | 9084-9088 | | |
| Activate RCO in own station | 9531 | X | | Recall to global group 1 | 9101 | | |
| Re-dial | 9532 | X | | Recall to any group | 765 | | |
| Wake-up call | 7883 | X | | Answer Group Call | 99 | X | X |
| Set station in OPEN | 7886 | X | | Group Call filter | 7931-7933 | | |
| Set station in PRIVATE | 7887 | X | | Group Call filter OFF | 7930 | | |
| CALL REQUEST | | | | Disconnect Group Call | 7884 | | |
| Call Request to CRM stations | 621 | X | | Ringling Group | 6701-6710 | X | X |
| Call Request, alarm | 622 | X | | CONFERENCE | | | |
| Call Request, ordinary | 623 | X | | Simplex Conference 1-50 | 8201-8250 | X | |
| Call Request, transfer | 7870 | X | | Simplex Conference OFF | 8200 | X | |
| PROGRAM DISTRIBUTION | | | | Duplex Conference 1-20 | 8301-8320 | X | |
| Program 1-6 | 801-806* | X | | Duplex Conference OFF | 8300 | X | |
| Program 7-70 | *** | X | | ALARM | | | |
| Next program (step up) | 790** | X | | Stored Voice Message | 8181-8182 | | |
| Previous program (step down) | 791 | X | | Mess. 1 to loc. group 1 | 9184 | | |
| Program on/off (toggle) | 792 | X | | Alarm messages | 8191-8199 | | |
| Program / conf. to person | 74 | X | | Alarm message OFF | 8190 | | |
| Program / conf. to group | 75 | | | Alarm message to group | 761 or 765 | | |
| Program / conf. to person on/off | 762 | X | | MULTI CONFERENCE STATION | | | |
| Program OFF | 800 or C | X | | MCS Activate | 7980 | | |
| PAGING | | | | MCS Priority | 7981 | | |
| Answer Paging (without display) | 96 | X | X | MCS Select | 7982 | | |
| Answer Paging 1-4 (with display) | 980-983 | X | X | MCS Talk-Back | 7983 | | |
| Direct Paging | 9700 | X | X | MCS Deactivate all | 7984 | | |
| EVENTS | | | | AUDIO MESSAGING | | | |
| User Event with tone | 9 533 | X | | Recording from station | 8180 | X | |
| User Event silent | 9534 | X | | Stored Voice message | 8181-8182 | X | |
| Two-step Event trigger | 9535 | X | | PA activation, multi-step | 765 | X | |
| Digit Event trigger | 9545 | X | | PA activation, one-step | 9084-9088 | X | |

| | | | | | | | |
|--|--|--|--|-----------------------------|------|---|---|
| | | | | PA to global group | 9101 | X | |
| | | | | Recorded message to group 1 | 9184 | X | |
| | | | | Auto-attendant | 9550 | | X |

* 805-806 in XE7

** Default is 6 programs + OFF

*** Not in Auto-load

2.5.6 System maintenance

System maintenance access is restricted to the Super User station connected to physical line number 1. This station has Class of Service 16, **All Functions**.

| FEATURES FOR SUPER USER STATION | | | |
|--|------------|-------------|--------------|
| <i>Feature</i> | <i>No.</i> | <i>CoS1</i> | <i>CoS15</i> |
| Set volume | 783 | | |
| Set time and date | 785 | | |
| Station ID (directory + physical nos.) | 789 | X | |
| AlphaCom IP configuration | 7810 | | |
| Install backup from EPROM | 7819 | | |
| Store backup to EPROM | 7820 | | |
| Reset board error | 7871 | | |
| AGA audio test | 7872 | | |
| Set access to feature | 7873 | | |
| Tone test | 7885 | | |
| Block alarm input | 7888 | | |
| Unblock alarm input | 7889 | | |

2.5.7 Control room stations

Stations used for control rooms such as guard locations in prisons, buildings, parking facilities, etc. may be a dedicated Control Room Master (CRM) station or a normal master station with display.

| CONTROL ROOM STATION FEATURES | | | |
|-------------------------------|------------|-------------|--------------|
| <i>Feature</i> | <i>No.</i> | <i>CoS1</i> | <i>CoS15</i> |
| CONTROL ROOM STATIONS | | | |
| Call Request, Alarm | 622 | X | |
| Call Request, Ordinary | 623 | X | |
| Call Request, Alarm | 624 | X | |
| Call Request, Ordinary | 625 | X | |
| Cancel Call Request | 626 | X | |
| Call request, Alarm | 627 | X | |
| Call Request, Ordinary | 628 | X | |
| Call Request transfer | 7870 | X | |
| Acknowledge Priority Mail | 7882 | | |
| MLH/CRM STATIONS ONLY | | | |
| Call request | 621 | X | |
| CRM ID | 786 | | |
| Lamp Test | 7874 | | |
| Lamp Test all | 7875 | | |

| | | | |
|----------------------------|------|---|--|
| Output time | 7876 | | |
| Reset this CRM/MLH station | 7877 | | |
| Reset all CRM/MLH stations | 7878 | X | |

2.5.8 Mail queue navigation

A mail message can be sent to any defined display station. The mail can contain a message about call request, technical alarms, and errors.

| MAIL QUEUE | | | |
|-------------------------------|------------|-------------|--------------|
| <i>Feature</i> | <i>No.</i> | <i>CoS1</i> | <i>CoS15</i> |
| Delete mail without answering | 7630 | X | X |
| Last mail in queue | 7633 | X | X |
| Previous mail in queue | 7637 | X | X |
| Call to sender of mail | 7638 | X | X |
| Next mail in queue | 7639 | X | X |

2.5.9 Dual Display station

The introduction of master stations with dual display where the second display can be programmed with DAK key names has lead to a series of specific feature codes.

| DUAL DISPLAY FEATURES | | | |
|----------------------------|------------|-------------|--------------|
| <i>Feature</i> | <i>No.</i> | <i>CoS1</i> | <i>CoS15</i> |
| Alphanumeric search | 9537 | X | |
| Edit DAK text | 9540 | X | |
| Program DAK | 9541 | X | |
| Dual Display menu | 9542 | X | |
| Dual Display DAK page down | 9543 | X | |
| Dual Display DAK page up | 9544 | X | |

2.5.10 Telephone functions

When calling an intercom station from an external telephone, the M-key (Simplex) can be simulated by the * and # keys on the telephone.

| USING TELEPHONES (SIP trunk) | |
|------------------------------|---------------------------|
| <i>Telephone function</i> | <i>Intercom function.</i> |
| External call | 0 |
| * key from telephone | M-key on |
| # key from telephone | M-key released |

2.5.11 AlphaNet

| NETWORK FEATURES | | | |
|------------------------|------------|-------------|--------------|
| <i>Feature</i> | <i>No.</i> | <i>CoS1</i> | <i>CoS15</i> |
| Prefix Exchange 1 | 54 | X | X |
| Prefix Exchange 2 | 55 | X | X |
| Global Group Call 1-10 | 9001-9010 | X | X |
| Build Global Group | 7879 | | |

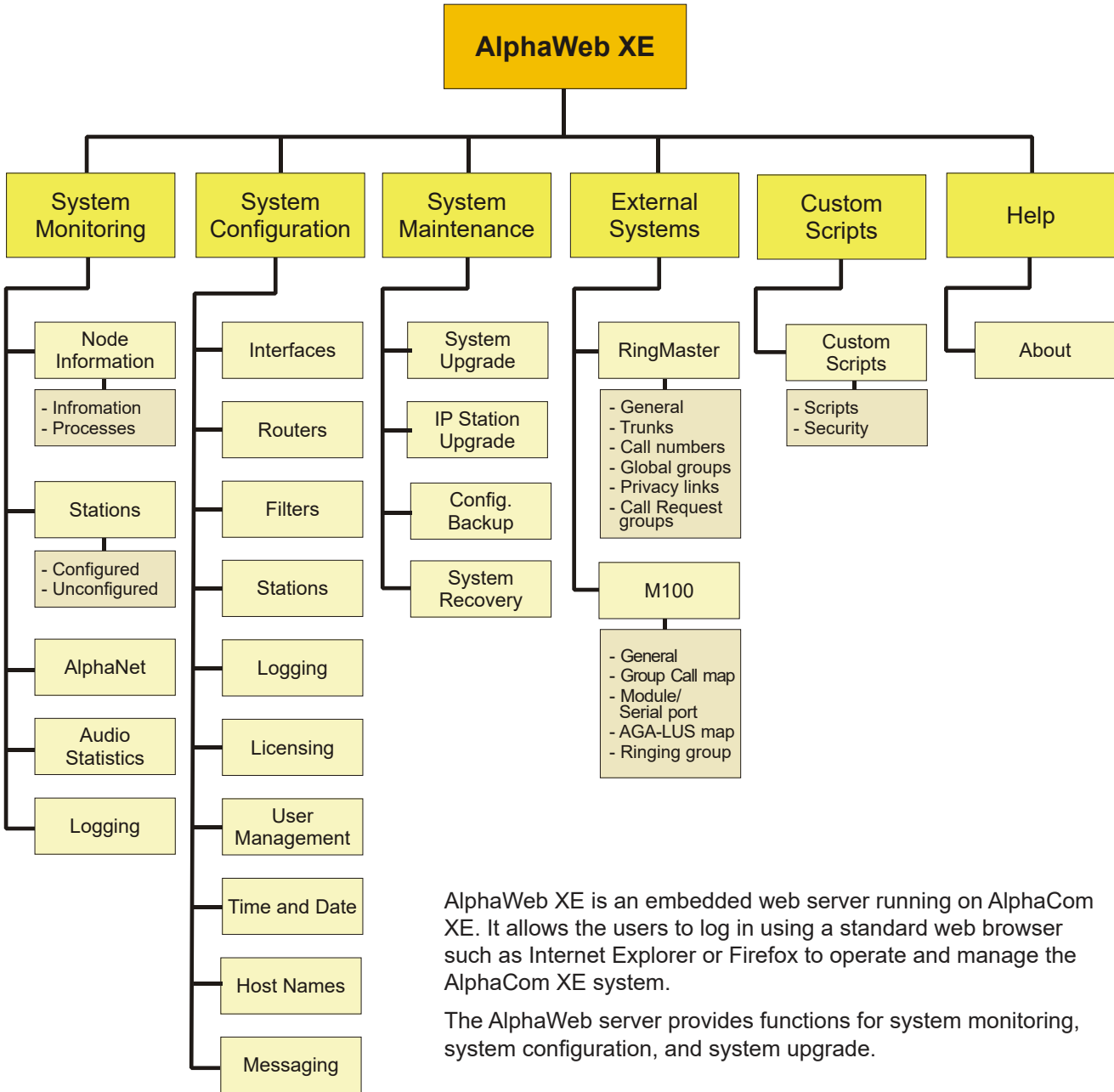

AlphaWeb XE is an embedded web server running on AlphaCom XE. It allows the users to log in using a standard web browser such as Internet Explorer or Firefox to operate and manage the AlphaCom XE system.

The AlphaWeb server provides functions for system monitoring, system configuration, and system upgrade.

3.1 Connecting to AlphaCom using AlphaWeb

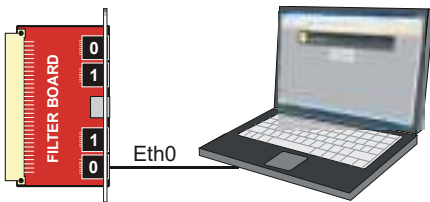

- Connect the PC Ethernet port to the LAN port (Eth0) on the AMC-IP filter card.
- Open your web browser to access AlphaWeb.
- ① *The factory default IP address of the AlphaCom server is 169.254.1.5. In order for your PC to communicate with the server, it is necessary to change its Internet Protocol Properties to use an IP address that is in the same range as 169.254.1.5.*
- Enter `http://169.254.1.5` in the address field
 - Connection with the AMC is verified by the text:
[Login] Secure AlphaWeb (https)
[Login] Unsecure AlphaWeb (http)
- Click **Login for Unsecure AlphaWeb (http)**
 - unless encrypted access to internet is required for safety reasons.

If **[Login] Secure AlphaWeb** is not shown, https may be activated in AlphaWeb by selecting **Filters** in the **System Configuration** menu (see section 3.4.4).



- The user will be prompted for a user name and password. To log in as a user with reading rights only, do as follows:

Default user name: **alpha**
 Default password: **com**

- To be able to change the configuration, the user must log in as an administrator. The default login will then be:
 User name: **admin**
 Password: **alphaadmin**

A window with server configuration information will be displayed:



3.1.1 Saving and applying changes

When new configuration parameters are entered, they should be saved to the configuration file by clicking **Save**.

The configuration data is then only saved to the AlphaCom configuration file and not applied to the running configuration. To get the new configuration data applied to the running configuration, click **Apply**.

3.2 Changing Default User Name and Password

It is recommended to change the default user names and passwords for security reasons.



- Select **System Configuration > User Management**
- Enter the old passwords for both Read access and Read/Write access (defaults: **com** and **alphaadmin**)
- Enter new user names and passwords

- Re-enter the new passwords to confirm
- Verify by clicking **Update User 1** and **Update User 2**
- Write down the selected passwords and keep them in a secure place.

3.3 Installing License Keys

To use AlphaCom features such as VoIP, AlphaNet, and SIP, the system requires software license keys. This license key is valid for one MAC address. Obtain the license key for the feature from your AlphaCom distributor.

Licensing

| License Type | # of Licenses | Currently Used | Available | Rejected |
|-----------------|---------------|----------------|-----------|----------|
| Billing | 0 | 0 | 0 | 0 |
| CRAC Stations | 0 | 0 | 2 | 0 |
| IP Analog Lines | 2 | 0 | 2 | 0 |
| IP Stations | 10 | 0 | 10 | 0 |
| MISD | 1 | 0 | 1 | 0 |
| Multi Line | 3 | 0 | 3 | 0 |
| OFC server | 40 | 4 | 36 | 0 |
| ReCall | 3 | 0 | 3 | 0 |
| Ring Master | 1 | 0 | 1 | 0 |
| SIP Stations | 2 | 0 | 2 | 0 |
| SIP Trunk Lines | 2 | 0 | 2 | 0 |

Showing 1 to 11 of 11 entries

License Key

| License Key | MAC Address |
|-------------|-------------------|
| | 88:00:35:02:23:D3 |

Insert new License Key

To install the license:

- Select **System Configuration > Licensing**
- Click **Insert new License Key**
- Enter the key string in the Input **License Key** field
- Click **Insert Key** to install the license.

3.4 IP Configuration

3.4.1 Overview

An IP address (Internet Protocol address) is a unique number that devices use in order to identify and communicate with each other on a network utilizing the Internet Protocol standard. An IP address consists of 32 bits. They are commonly expressed as a dotted quad, four octets (8 bits) separated by periods.

IP addresses are divided into two parts:

- **Network address**
 - identifies a whole network or subnet
- **Host address**
 - identifies a particular device's connection or interface to that network

This division is used to control how traffic is routed in and among IP networks. It is the Subnet Mask that decides which part of the IP address is the Subnet number and which part is the Host number.

3.4.2 IP interfaces

To connect the AlphaCom XE to your IP network, you need to enter the IP settings for the Ethernet ports and IP route entries according to network. You should obtain IP addresses and IP routes from your IT network administrator.

Set the IP address for Ethernet port 0 and/or 1

- Log in to AlphaCom via AlphaWeb
- Select **System Configuration > Interfaces**
- Enter the **IP Address**
- Enter the **Subnet Mask**

- Click **Save** to save the values

① Do **NOT** click **Apply** until all address, routing and filter changes as described in sections 3.4.2, 3.4.3 and 3.4.4 have been saved!

3.4.3 Configure IP routing

The IP Routing table of AlphaCom must be configured if there is a need to communicate with a device outside its own subnet. A “device” could be another AlphaCom, a PC (AlphaPro, AlphaWeb, SysLog), SIP gateway, etc. If AlphaCom and the device belong to the same subnet, there is no need to specify any routing information.

Route types

Route type *Host* is used to set up a route to a single device outside the subnet of AlphaCom.

Route type *Net* is used to set up a route to another network.

Route type *Default* is used to set up a general route to any device outside the subnet of AlphaCom.

- Select **System Configuration > Routes**
- Select the type of IP route by clicking **Add Route**
 - **Default IP route**
Enter only **Gateway** (IP address) and **Out Interface** Ethernet port (eth0/1)
 - **Network route**
Enter **Destination IP** address, **Destination Mask**, **Gateway** and **Out Interface** Ethernet port (eth0/1)
 - **Host route**
Enter **Destination IP** address, **Gateway** and **Out Interface** Ethernet port (eth0/1)

3.4.4 Internal firewall

AlphaCom XE has an internal firewall allowing the network administrator to open and close IP services that accesses the AlphaCom XE from the different networks. By default, the AlphaCom XE comes with the most restrictive firewall settings.

- Select **System Configuration > Filters**
- Select the protocols that should be allowed for each Ethernet port by clicking the relevant checkboxes **Eth0** and **Eth1**
- If you want other protocols to be allowed, click **Add Filter** to add a new protocol to the filter table:
 - Enter the **Protocol Name**
 - Select protocol type - **TCP/UDP**
 - Enter the port number - **Port (Lo:Hi)**
- Click **Apply** when all addresses, routing and filter changes as described in sections 3.4.2, 3.4.3 and 3.4.4 have been saved!

AlphaCom XE should now be connected to your IP network.

4.1 Overview

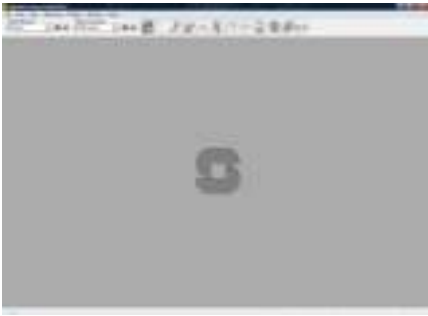

AlphaPro 11 is the tool for configuring the AlphaCom XE system. It is self-contained, and simple to install and use. When a new server/exchange shall be configured, it is given a working default factory setting (see tables in section 2.5). The operator can modify the settings such as:

- Directory information
- Groups
- Interfaces to CCTV, PA, paging, DECT
- AlphaNet
- Other custom behavior

There are currently over 100 defined features which can be programmed with AlphaPro 11.

AlphaPro 11 is an off-line tool. This means that it is possible to enter all parameters without being connected to the server/exchange. Once all parameters are entered, AlphaPro 11 can be connected to the server/exchange and the parameters can be sent. AlphaPro 11 can also upload configuration information from a server/exchange.

AlphaPro 11 connects to a server/exchange via the IP network or a local RS232 interface.

4.1.1 AlphaPro versions

AlphaPro 11 comes in two versions. A hardware dongle is used to differentiate between the versions.

There are two types of hardware keys, one for parallel port and one for USB port.

The versions of AlphaPro are:

- **AlphaPro M**
 - Runs without a hardware key.

It gives access to all features (except AlphaNet), and is only for 36 subscribers.

- **AlphaPro Professional**
 - Uses the Professional hardware key.

It gives access to all features. This version must be used when extensive changes to the default Auto-load is made.

4.1.2 Backwards compatibility

AlphaPro version 11 supports:

- AlphaCom E, AMC-IP version 10.xx
- AlphaCom AMC version 9.x

① ***Older AlphaCom systems can easily be upgraded to AlphaCom XE.***

AlphaPro 11 supports uploading and conversion of an AMC version 9 configuration database to an AMC-IP configuration database.

4.1.3 PC requirements

- Windows 2000, Windows XP
- 800 MHz or higher processor clock speed
- 256 MB of RAM or more
- 40 MB free space on the hard disk for the AlphaPro program
- 5 MB free space on the hard disk for each server to be programmed
- 1 free parallel or USB port for Hardware Key
- XGA (1024x768) or higher resolution video adapter and monitor
- Network card
- CD or DVD drive
- Optional: 1 free RS-232 port for communication if connecting to AlphaCom AMC version 9

4.2 Getting Started with AlphaPro

4.2.1 PC setup

- Download AlphaPro 11 from www.zenitel.com or insert the CD-ROM with the AlphaPro 11 installation.
- ① ***The instructions are based on AlphaPro 11 version. Other versions may have slightly different images and/or procedures.***
- Select and run the file *installalphapro.exe*
 - Follow the instructions on the screen
 - You can safely answer “YES” to all questions

4.2.2 Insert the HW dongle

- Insert the hardware dongle in the PC's parallel or USB port depending on the dongle type
- Leave the dongle in the PC during programming and transferring of data to the server.

If the dongle is not inserted, the AlphaPro will run in AlphaPro M mode. You will still have access to all functions (except AlphaNet), but only for 36 subscribers.

4.2.3 Connect a PC to the server

AlphaCom XE - Ethernet connection

AlphaCom XE servers communicate with AlphaPro on the PC over the IP network. Eth0 is the default management port unless the configuration has been changed.

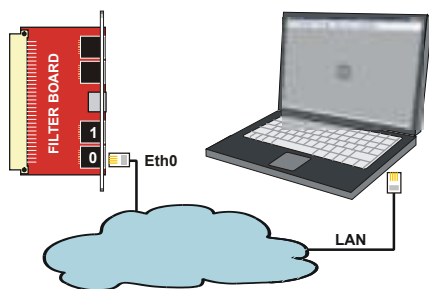

When the AlphaPro communication icon  is clicked, you will be prompted for user name and password to log into AlphaCom.

- In AlphaCom XE20 and XE26, the Eth0 port is the lower RJ connector on the AMC-IP filter board.
- In AlphaCom XE7, the Eth0 port is the left-most RJ connector on the backplane.
- In AlphaCom XE1, the Eth0 port is the left-most RJ connector at the rear.

4.3 Defining Network and Exchange

If you are going to program the server/exchange for the first time, make sure that the AlphaCom system has been cold-started (see section 2.3). The default programming tables will then be loaded. The Auto-load values are found in section 2.5.

4.3.1 Initial programming



- Open AlphaPro by clicking on the S-icon on the PC's desktop.
- When AlphaPro starts for the first time, you will be asked to make an AlphaPro database by creating a network and adding the exchange that is part of the network.

Enter network

- Enter a system name related to customer or network.
 - maximum 23 characters
 - don't use national characters like æ, ø, å, ä, é, etc.
- It is possible to create more networks later on from the main window.

Enter exchange

- Enter the first node (exchange) name
 - maximum 16 characters.
- The first exchange node number is 1
- Select the desired type of node (exchange type)
 - AlphaCom E is default.
- Select the display language for the stations in the exchange.
 - Available languages are: Danish, Dutch, English, Finnish, French, German, Hebrew, Norwegian, Spanish, and Swedish.
 - English is the default.
- Checkbox for **AlphaNet: Adm. Here**
 - Creates an exchange with full database, which can be configured from this PC.
 - Creates an exchange without database which can be pointed to in AlphaNet routing.

Enter IP address

- Normally Eth0 is used for connection to the exchange.
- Leave the filled-in default IP address.
 - If the system is part of an AlphaNet, it will be connected to Eth1. If this IP address is unknown at this moment, it can be filled in later.
- Click **OK** to proceed to the AlphaPro main window.

Then you can:

- Select the exchange you are going to program
- Add networks and nodes
- Set up data communication with the exchange
- Go to the different programming windows

4.3.2 Add network or exchange

Network

- In the main window, select [+] next to the **Select Network** pull-down menu
- Proceed as explained in 4.3.1

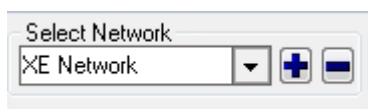

Exchange

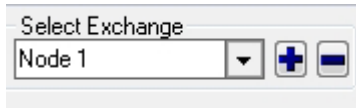

- In the main window, select [+] next to the **Select Exchange** pull-down menu
- Proceed as explained in 4.3.1
 - The Node Number applies to AlphaNet nodes
- If this exchange is part of an AlphaNet, select Eth1 and enter the IP address.

4.4 Data Communication

In order to establish communication between the PC and the exchange, the communication program must be started.

- ① ***During data transfer to the AlphaCom, it is not possible to modify configuration data in the AlphaCom.***

4.4.1 Establishing data communication



- Select the exchange in the Main Window
- Click on the **Communication** icon
- The program will ask you for user name (default: **admin**) and password (default: **alphaadmin**)
 - The Communication window appears
 - The connection is confirmed when the communication is established and the buttons become active.



- ① ***If the PC is not connected to the exchange, a fault warning will pop up. You may skip the data transfer until data changes have been carried out off-line.***

4.4.2 Send information to the exchange



- Click **SendAll** to send all data
- Click **SendChg** to send changed data only
 - An icon in the lower right corner flashes during transmission.
- The transmission may be stopped by clicking **Cancel**
 - The **Cancel** key changes to **OK** when the transmission is completed. Click **OK**.

4.4.3 Get information from the exchange

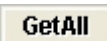

- Click **GetAll** to get all data from the exchange

4.5 Communication Window Actions



Send changed data from the PC to the exchange or to all exchanges in an AlphaNet.

- It may take about 60 seconds after the data has been sent for changes to take effect for an exchange in normal operation.
- Some changes will require a reset for the changes to take effect.



Send all data from the PC to the exchange.

- Use this option after major configuration changes or to be sure that

the database is identical to the exchange tables in NVRAM.

① ***Do NOT do a SendAll to an exchange in normal operation!***

- Perform an exchange reset after **SendAll**.

GetAll

Get all data from the exchange to the PC.

- The data can be stored in the current database or in a new auto-loaded database.
- The configuration may be changed afterwards.

Backup

Read data from the exchange NVRAM and store it in a PC file.

- This file can not be changed by AlphaPro as it is just a backup.

Restore

Send data from a PC backup file into the NVRAM in the exchange.

- The NVRAM version that created the backup must be identical to the NVRAM version in the exchange.
 - If they are different, trust the database information and do a **SendAll**.
- Always do a reset of the exchange after **Restore**.

Reset

Restart the exchange without changing the programming.

- The exchange will halt and all activities will be affected.

Time

Set the exchange clock.

SetNode

Modify the node number in the exchange.

- If the node number in the exchange is not the same as the node number in the AlphaPro database, the login will fail. This command allows you to modify the node number in the exchange.
- After Autoload, the exchange will have node no. 1. In a network of exchanges (AlphaNet), each exchange must have its unique number.

4.6 AlphaPro Menu Structure



Use the menus in AlphaPro to change the default system setup. The menu bar at the top of the screen has 12 main menus accessed by clicking on its icon. Each main menu will have one or more selectable tabs or submenus.

AlphaPro may be run without being connected to AlphaCom (off-line), and all changes can be saved to the PC and copied to the system later on.

It is good practice to start the programming in the **Exchange & System** menu and continue rightwards on the menu bar.

The menu structure for AlphaPro Professional is shown in the following figures.

① ***The menu structure in this section is based on AlphaPro 11. Other versions may differ slightly.***

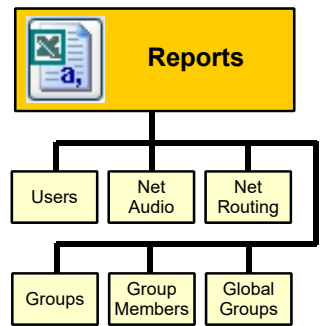
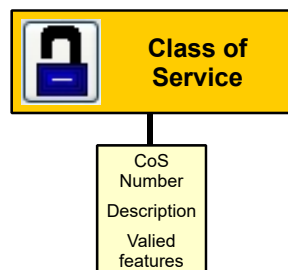
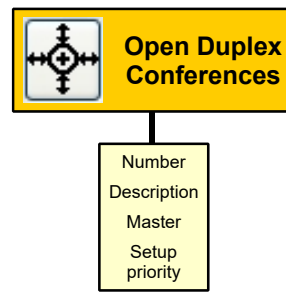
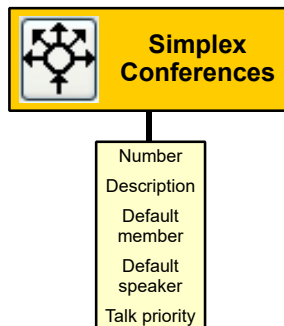
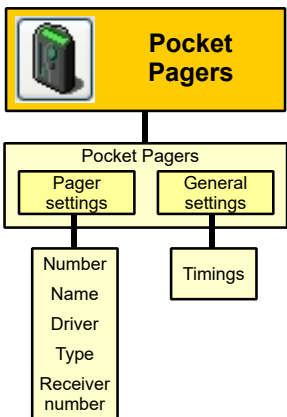
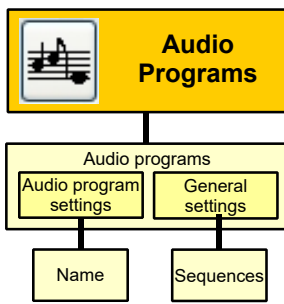
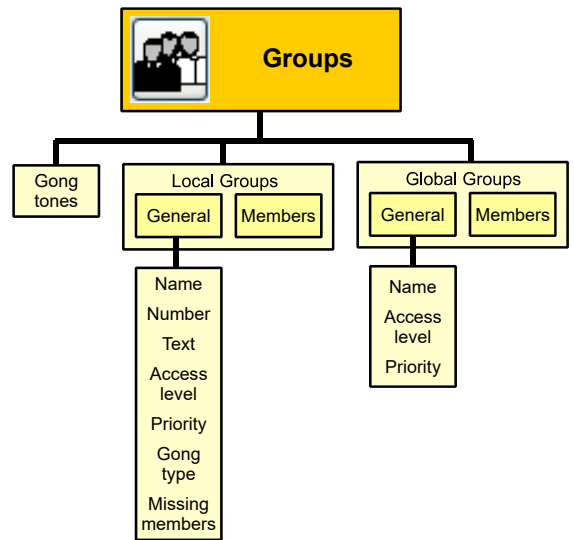
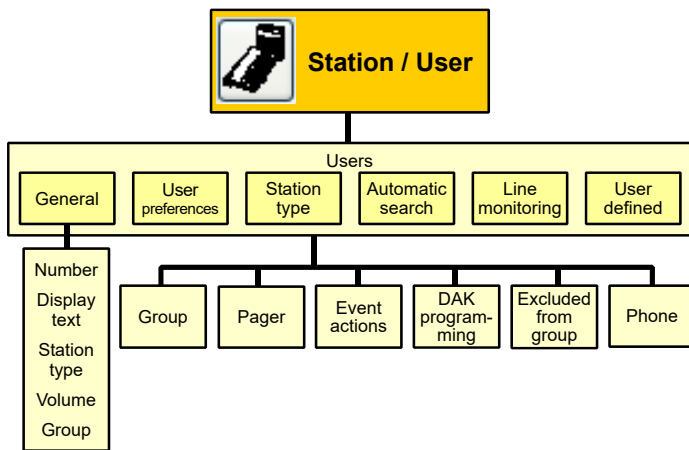
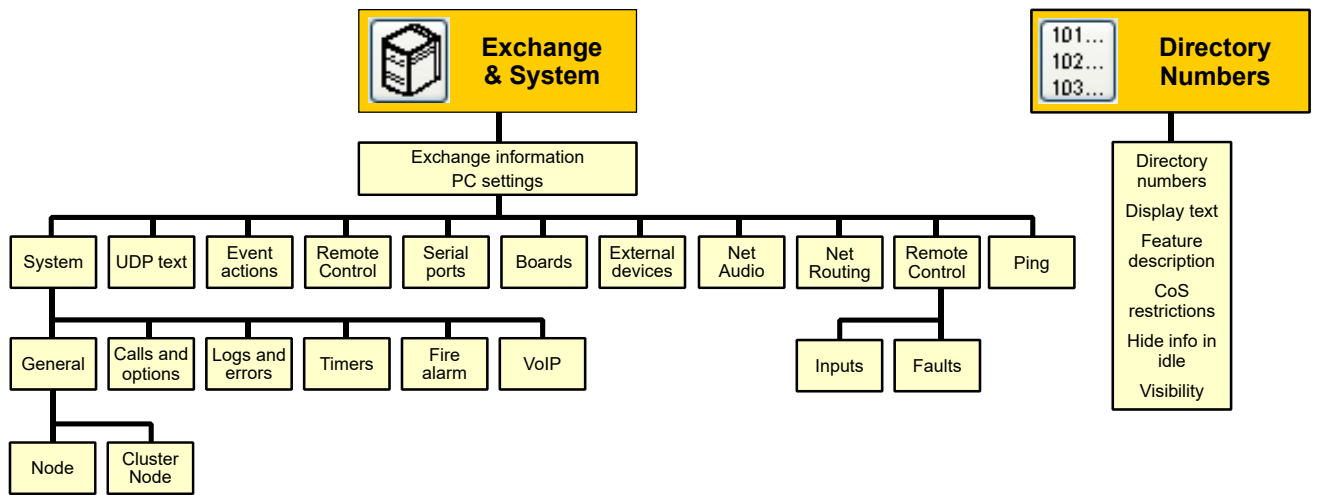

5 Station Configuration

5.1 Configuration in AlphaPro



Configuration of stations and users are undertaken in the **Users & Stations** section of AlphaPro.

Configuration of stations are done by filling in the fields under **Users & Stations**.

The main fields for a normal configuration are:

- Physical Number
- Directory Number
- Display Text
- Station Type
- Visibility

To configure stations, click the **Users & Stations** icon.

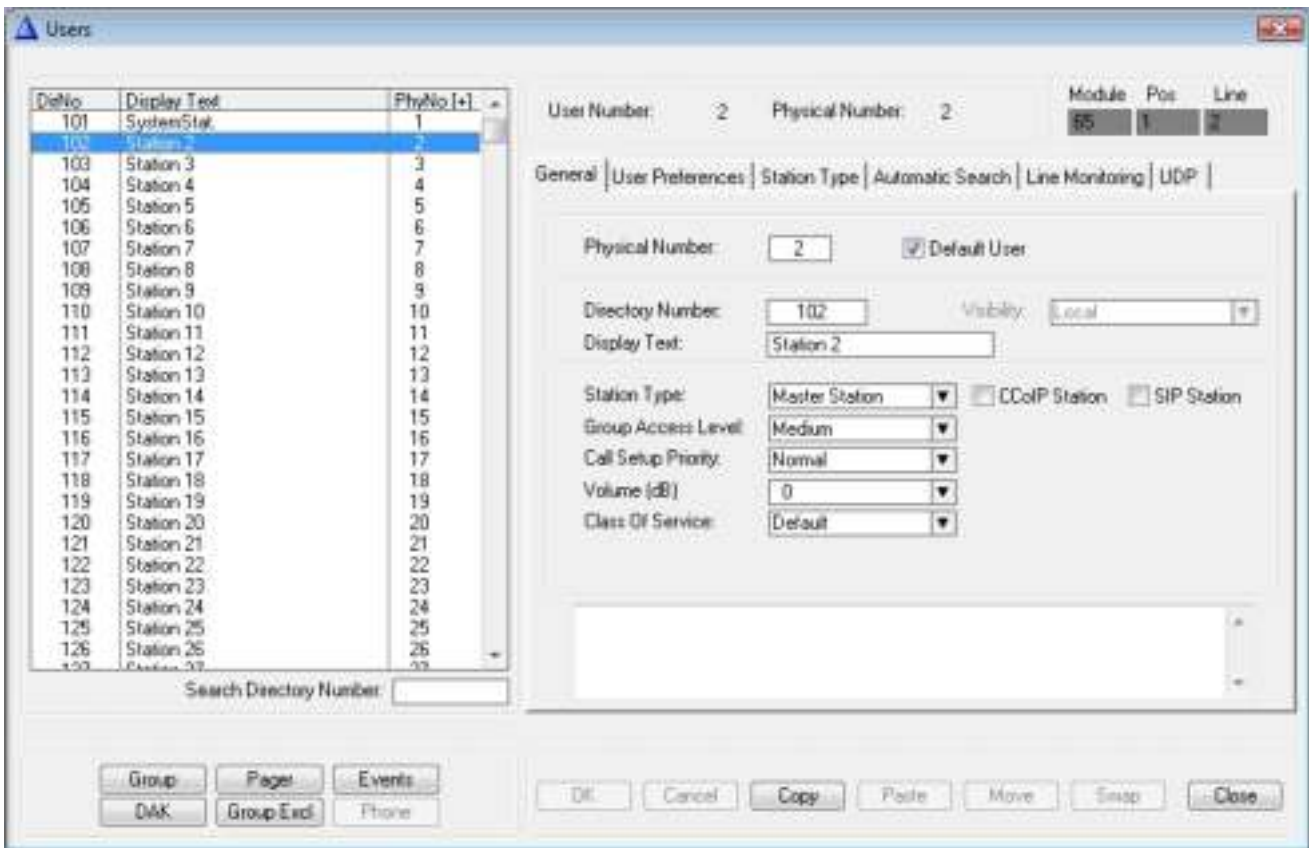

All stations are identified by the exchange with its physical number.

The physical number for a star-wired station is the number of the physical wire connection point on the ASLT or ATLB card.

IP stations must also be given physical numbers to follow the same logic. This number can be any number below 552, but must not overlap star-wired station physical numbers.

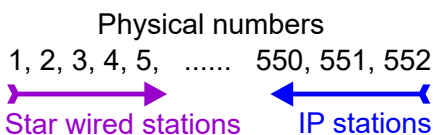

① Start numbering the IP stations from 552 and downwards to avoid occupied number problems if the exchange is extended with more star-wired stations later on.

- **Directory Number** is the number to dial to reach the station.
 - The default number can be changed to any 2-8 digit number starting with 1, 2, 3, 4 or 5. Numbers with first digit 6-9 are reserved for functions. If these numbers should be used, the corresponding function code must be changed. (See section 2.5.1.)
- **Display Text** is the station ID text shown in the called station's display.

- The text should normally be the station location or the subscriber's name. The maximum number of characters is 16 including the station directory number.

- **Visibility** can be set to **Local** or **Global**. Visibility is related to AlphaNet when cluster programming is used. See section 6.2.6.
 - *Local*: station can be addressed inside the node only.
 - *Global*: station can be reached from all nodes in a cluster.

A cluster is a subnet of a network, and consists of a number of defined nodes.

- **Station Type** is used to define the type of station on the actual physical number.
 - **Master Station** is the default option. This setting will automatically detect the type of station connected.
 - **Sub Station** should be selected for stations with limited keypad and PA couplers to avoid e.g. "call me" messages.
 - **Display Station** can be selected to ensure faster and safer line error detection on stations with displays.

Other special station options can be selected to obtain optimal performance and programming for the relevant stations.

- **CCoIP** or **SIP** stations are selected by ticking the appropriate checkbox.
- The **CCoIP Station** checkbox results in a field for MAC address and a checkbox for registration with directory number.
 - AlphaCom XE can use both methods for identifying an IP station.

When configuring an IP station in AlphaPro, you must select which methods to use to identify the IP station. The advantage of using registration by directory number is that it is easier to replace the station at a later stage as this does not require new settings in AlphaPro.

Configuration window for CCoIP Station. The **CCoIP Station** checkbox is checked. Below it, the **Reg. w/ Directory Number** checkbox is also checked. The Codec is set to 'Best Available' and the Packet size is 20 (ms).

Configuration window for CCoIP Station. The **CCoIP Station** checkbox is checked. The **Reg. w/ Directory Number** checkbox is unchecked. A MAC Address field is present with the value '0013CB'. The Codec is set to 'Best Available' and the Packet size is 20 (ms).

Configuration window for SIP Station. The **SIP Station** checkbox is checked. The Codec is set to 'G711u' and the Packet size is 20 (ms).

Directory Number registration

- This is the default registration for CCoIP stations.
- Tick the **Reg. w/Directory Number** checkbox to register the station.

MAC address registration

- Untick the **Reg. w/Directory Number** checkbox to bring up the MAC address field.
- Enter the station's MAC address.
The MAC address can be found by logging into the web interface of the IP station or AlphaWeb under **System Monitoring > Stations > Unconfigured**.

SIP Station

Tick the **SIP Station** checkbox if the station is a SIP telephone.

When a change has been made to a directory number, the **OK** and **Cancel** buttons become active.

The settings for a station can be swapped with another station by doing the following:

1. Highlight the first station in the list
2. Click the **Copy** button and then highlight the second station
3. Click the **Swap** button to swap the two stations.

- ① **Ordinary analog telephones can be connected by using ATLB cards. No configuration is needed to make the phone function as an ordinary station. The 'station type' is set to Master Station.**

5.2 Additional IP and SIP Station Configuration

Complete information about the mounting and configuration of IP stations are found in the manuals:

- A100K10788 IP Master Station Installation & Configuration
- A100K10803 IP Substation Installation & Configuration

SIP stations and gateways are described in the manuals:

- A100K10812 SIP Substation Installation & Configuration
- A100K10333 SIP Analog Gateway
- A100K10390 SIP GSM Gateway

5.3 IP DECT SIP Station Configuration

A typical IP DECT System comprises the following components:

- IP DECT Server 6000
- Base Stations
- Repeaters
- Administrative Computer
- Handsets and accessories

The IP DECT Server 6000 communicates with the AlphaCom exchange over a LAN (Local Area Network).

The configuration process includes:

- Configuring the Server
- Configuring the Base Station
- Registering a Handset
- Subscribing a Handset
- Configuring the Exchange

The complete procedure is described in the manuals:

- A100K10652 IP DECT Installation & Configuration
- A100K10777 IP DECT Quick Configuration Guide

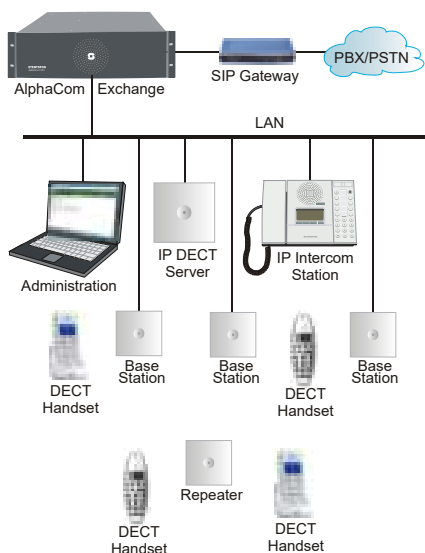

6.1 Overview

AlphaNet is STENTOFON's internal networking technology developed for critical communications. Some of the feature highlights of AlphaNet are:

- Group and conference calls
- VoIP bandwidth management
- Priority handling of events and resources
- Alternative routing
- Backwards compatibility
- All features available over the network
- VoIP, digital and analog infrastructure support
- SIP clients

Group and conference calls

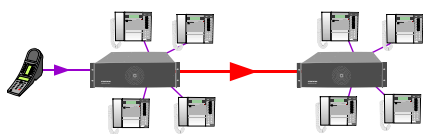

AlphaNet has full group and conference call capability.

Each AlphaCom XE has a built-in multi-party conferencing unit, providing local mixing for group and conference calls. This local mixing allows AlphaCom XE to only use a single VoIP channel when setting up a group or conference call between servers.

VoIP bandwidth management

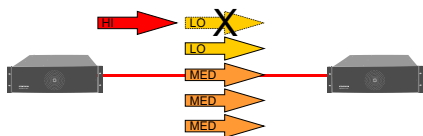

AlphaNet provides bandwidth management, limiting the VoIP bandwidth from taking more capacity than provisioned.

If a high priority call is set up when all VoIP channels are occupied, AlphaCom XE will immediately release the call with the lowest priority, thus allowing the high priority call to proceed.

Priority handling of events and resources

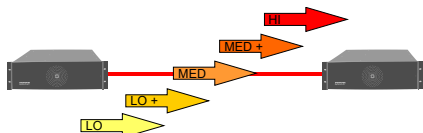

All calls and events that are sent between nodes are marked with priority.

This allows the system to act upon the priority, presenting and handling the events and calls in the correct order.

Alternative routing

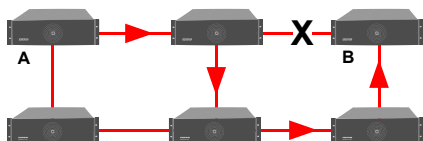

Alternative routing of calls allows call completion even when the primary AlphaNet route is down.

For alternative routing, AlphaCom XE can either use its secondary IP interface or route the call over a traditional interface such as an analog or digital line.

Backwards compatibility

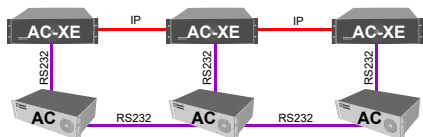

AlphaCom XE provides 100% backwards compatibility between traditional AlphaNet technologies and the new VoIP AlphaNet.

This backwards compatibility allows the mixing of new AlphaCom XE nodes working over IP with current nodes so configuration can be maintained.

- ① **AlphaCom XE has two RS232 ports which can be used for AlphaNet. If more ports are needed, an Ethernet to RS232 converter must be used.**

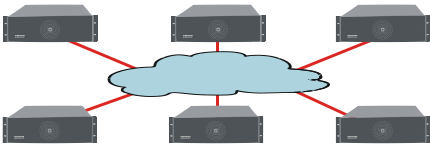

All features available over the network

Consistent features and services across the enterprise regardless of location enhances user friendliness.

AlphaCom XE provides all current AlphaNet features available today, including the enhanced features of LAN/WAN connection.

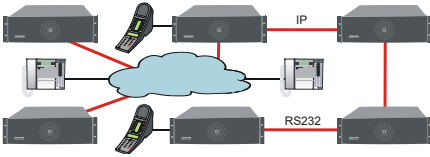

VoIP, digital and analog infrastructure support

AlphaNet works over any infrastructure, whether it is IP, digital or analog.

SIP client interface

AlphaNet provides integration with GSM, analog, ISDN and DECT telephones via SIP gateways. Most system functions are available between the telephones and intercom stations.

6.2 VoIP AlphaNet Configuration

6.2.1 Overview

See the *Network Design Guide A100K10313* for more information.

The following procedure is required when configuring AlphaNet:

- Insert AlphaNet license if VoIP AlphaNet should be used
- Create all the exchanges in the AlphaNet
- Create AlphaNet data routing
- Create AlphaNet audio routes
- Update the directory

6.2.2 Insert AlphaNet license

This must be done if VoIP AlphaNet should be used (see section 3.3).

6.2.3 Create all the exchanges in the AlphaNet

Define the exchanges in AlphaPro under **Network & Exchanges**. See section 4.3 on how to create the exchanges.

- ① *In some cases, it is not desired to program all the exchanges in the AlphaNet in the same AlphaPro database. In this case you should add the exchange in the network but un-tick the checkbox for 'AlphaNet - Adm. Here'.*

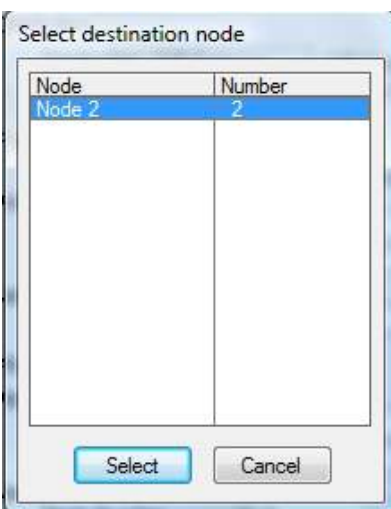

6.2.4 Create AlphaNet data routing

AlphaNet link between AlphaCom XE servers

- Select the AlphaCom XE server in AlphaPro
- Click the **Exchange & System** icon
- Click **Net Routing**
- Click **Insert**
- Select the destination AlphaCom node for the AlphaNet

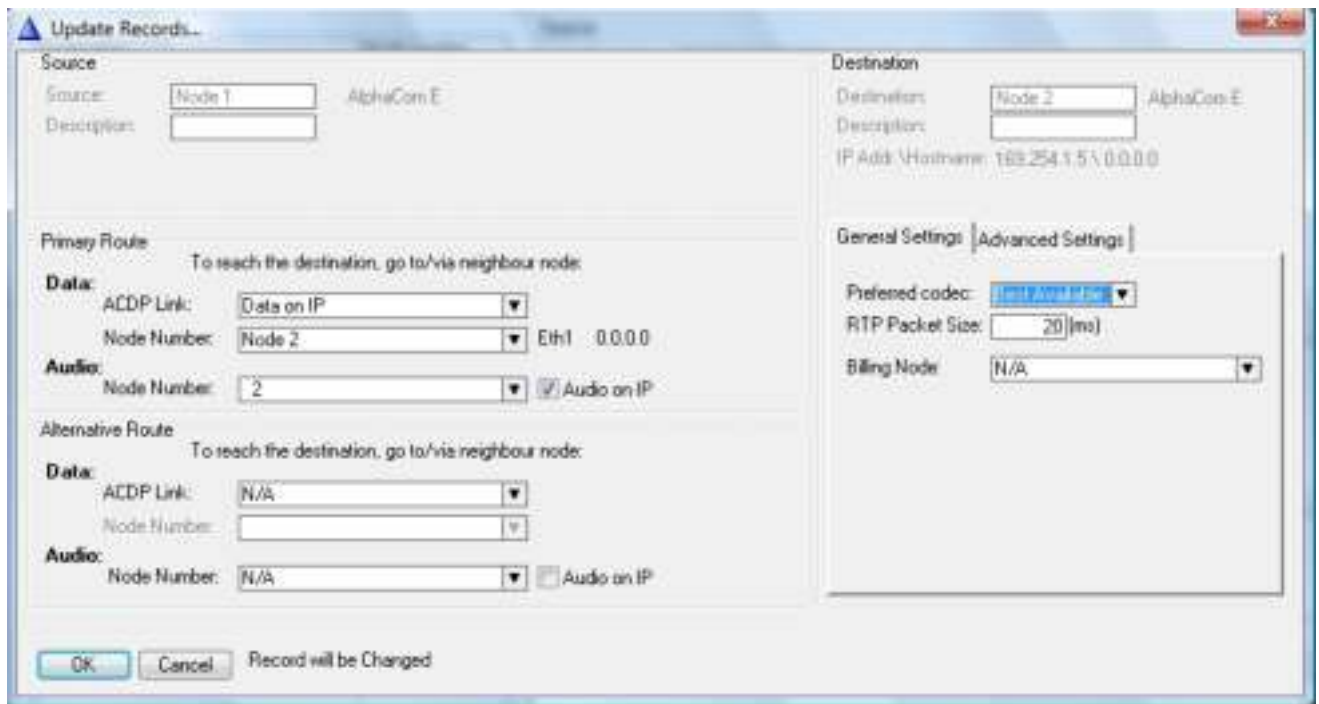

Configure primary route

- Select **Data on IP** as **ACDP Link**
- Select node number for both **Data** and **Audio**
- Tick the **Audio on IP** checkbox if a VoIP audio link shall be used
- Option: Configure an alternative route
- The **Preferred codec** should be set to **Best Available**
- Click **OK**

AlphaNet link to traditional AlphaCom servers

- Select the AlphaCom server
- Click the **Exchange & System** icon
- Click **Serial Ports**
- Select a free **ACDP Link** (AlphaCom Data Protocol)
- Click **Change**
- Tick the **Enabled** checkbox to enable the port and select the serial port for AlphaNet from the **Port Type** drop-down list.
- Set **Link Type** as **Stentofon Link Layer – AlphaNet**
- Click **OK** and close the serial port window
- Select **Net Routing**
- Click **Insert**
- Select the remote AlphaCom node for the AlphaNet
- Configure the primary route
- Select the **ACDP Link** that was configured for AlphaNet
- Select the **Node Number** for both **Data** and **Audio**
- Do NOT tick the **Audio on IP** checkbox
- Option: Configure an alternative route
- Click **OK**

① ***For each AlphaCom, it is required to configure AlphaNet links to the AlphaComs that it communicates with.***

6.2.5 Create AlphaNet audio channels

Audio channels must be defined when using a **Static** AlphaNet license. It is not necessary when a **Dynamic** AlphaNet license is used.

Create VoIP audio channels

| | | |
|--------------|--------|------------|
| Source: | Node 1 | AlphaCom E |
| Description: | | |
| Physical no: | 605 | |
| Mod | Pos | Line |
| 65 | AMC | 1 |

Channel: 1

In AlphaPro, select the AlphaCom exchange:

- Click the **Exchange & System** icon
- Click **Net Audio**
- Click **Insert**
- Select the destination node and click **Select**
- Enter the parameters as shown
- Confirm by clicking **OK**

Repeat the insert operation for the number of wanted VoIP audio channels.

① **The physical numbers 605 to 635 are logical numbers inside AlphaCom XE and are reserved for VoIP AlphaNet and SIP.**

- Click **Close** to close the *AlphaNet Audio Connections* window
- Click **Close** to close the *Exchange Information* window

Create circuit switched audio channels

- Select the AlphaCom exchange
- Click the **Exchange & System** icon
- Click **Net Audio**
- Click **Insert**
- Select the destination node and click **Select**

| | | |
|--------------|--------|------------|
| Source: | Node 1 | AlphaCom E |
| Description: | | |
| Physical no: | 120 | |
| Mod | Pos | Line |
| 65 | 20 | 6 |

Channel: 2

| | | |
|--------------|--------|------------|
| Destination: | Node 2 | AlphaCom E |
| Description: | | |
| Physical no: | 125 | |
| Mod | Pos | Line |
| 65 | 21 | 5 |

Use dynamic license

Mod: Automatically entered when the physical number is defined.

Connect to main Frame:
Module 65 - Master
Module 66 - 1st Slave
Module 67 - 2nd Slave
Module 68 - 3rd Slave

Pos: Board position number (1-26)

Line: Station line on ASLT board (1-6)

- Enter the physical numbers in the **Source** and **Destination** nodes as shown
- The module, position and line numbers are automatically defined when the physical number is entered. See the appendix for an overview of physical numbers in AlphaCom.
- Confirm by clicking **OK**
- Repeat the **Insert** procedure for the number of desired audio channels.

6.2.6 Cluster node programming

Cluster programming is an option for simplifying the programming and updating of numbers in AlphaNet when operating with integrated number series.

The exchanges can be given a *Cluster Node Number*. Nodes with the same Cluster Node Number (1-255) are members of the same cluster.

Stations in these nodes can be given one of three AlphaNet Visibility cluster modes.

To get access to the **AlphaNet Visibility** menu, the exchange has to be given a *Cluster Node Number*



- Click the **Exchange & System** icon
- Select the actual exchange
- Click **System**
- Enter a number between 1-255 in the **Cluster Node** field
- Verify by clicking **OK**
- Repeat the procedure for all actual exchanges
 - Nodes with the same Cluster Node Number are members of the same cluster.
- Click the **Users & Stations** or **Directory & Features** icons to select or create new directory numbers to be changed from the default status *Cluster Local*
- Select *Cluster Global* or *Cluster Identical* from the drop-down menu under **AlphaNet Visibility**



Cluster Local

The directory number will not be copied to the other exchanges in the cluster node.

Cluster Global

The directory number and name will immediately and automatically be copied to the other exchanges in the AlphaNet database as a global number (feature 83).

If the number exists from before in any of the other exchanges, it will be deleted. *AlphaNet Visibility* will be set to *Cluster Automatic* in the other exchanges.

- **Modifying:**
 - When modifying the number or name of an existing global user, do the modification in the exchange where the user is physically connected, i.e. where the visibility is set to *Cluster Global*.
- **Deleting:**
 - When deleting a directory number that has visibility *Cluster Global* or *Cluster Automatic*, it will automatically be deleted from all cluster nodes.

Cluster Identical

The directory number and name will be copied to the other exchanges. The feature number will be identical in all exchanges, i.e. the feature will remain local in each exchange but with the same number and name.

AlphaNet Visibility will be set to *Cluster Identical* in all exchanges.

6.2.7 Update the directory in each exchange

Create directory number for AlphaNet Area Codes

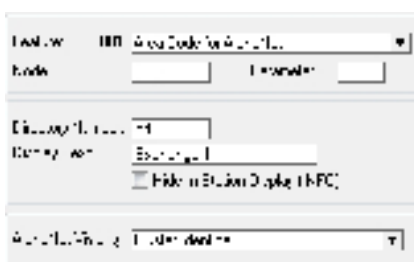

- Click the **Directory & Features** icon
- Select the directory number for the exchange
- Click **Insert**
- Select *Area Code for AlphaNet – 81* from the **Feature** menu
- Enter the node number for the exchange owning the area code
- Enter the directory number you want to use as area code

- Select **Cluster Identical** from the **AlphaNet Visibility** menu
- Confirm by clicking **OK**

Make AlphaCom stations visible in the AlphaNet cluster

The screenshot shows a configuration window with several fields. The 'AlphaNet Visibility' dropdown menu is open, showing 'Cluster Global' as the selected option. Other visible fields include 'Directory Number' with the value '110' and 'Exchange' with the value 'Exchange 1'.

- Click the **Users & Stations** icon
- Select the station that should have a global number
- Select *Cluster Global* from the **Visibility** drop-down list
- Confirm by clicking **OK**

Cluster Global can also be set from the **Directory & Feature** menu. All stations can then be set in one operation.

Manually create directory number for Global Numbers for AlphaNet

The screenshot shows a configuration window for a feature. The 'Feature' dropdown is set to '083 Global Number for AlphaNet'. The 'Node' field contains '1', 'Parameter 2' is empty, and 'Parameter 3' contains '0'. The 'Directory Number' field contains '794' and the 'Display Text' field contains 'Global no'. There is an unchecked checkbox for 'Hide In Station Display (INFO)'. The 'AlphaNet Visibility' dropdown is set to 'Local'.

- Click the **Directory & Features** icon
- Click **Insert**
- Select *Global Number for AlphaNet – 83* from the **Feature** drop-down list
- Enter the node number for the exchange
- Enter the directory number you want to use as global number
- Confirm by clicking **OK**
- Leave the **AlphaNet Visibility** at *Local*

7 Multi-Module Network

7.1 Overview



If the number of subscriber lines in one AlphaCom XE26 (138 lines) is exceeded, up to 4 modules can be combined to form a multi-module unit with a maximum capacity of 552 lines.

The multi-module concept uses one master module and up to three slave modules. The multi-module acts as one server with full integration of all features. All configuration data is stored on the Master AMC board.

The connection between the modules is via an IP network similar to AlphaNet.

- Multi-module is recommended when the modules are located in the same building/complex.
- AlphaNet is recommended when the modules are located apart from each other

Main features of AlphaCom XE IP-based Multi-Module:

- Same high degree of feature integration as conventional multi-modules
- No additional AlphaCom hardware required
- License is needed in the master module only
- Point-to-point connections (not in a ring as in conventional multi-modules)
- The modules need to be on the same LAN
- Optional Autonomic mode
 - The AMC Master can be set to copy its contents to the slave modules over a 28 hour period
 - In case of master-slave communication error, the slave will restart in autonomic mode, making it possible to communicate normally within each module.

7.2 Installation

- Interconnect the modules via an Ethernet switch as shown in the figure.
- Perform a cold start on each module separately

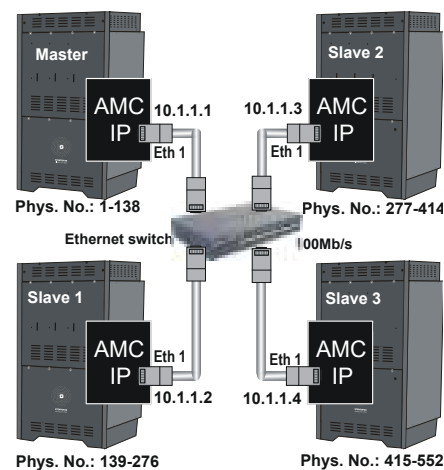

AlphaWeb

- Assign an IP address to each module (see sections 3.4.2 and 3.4.3)
- Enable *Multimodule Data* and *VoIP Audio* in the **Filters** setting (see section 3.4.4)
- Enter the Master license key to enable the Multi Module (see section 3.3)

Firewall Filter Settings

| Protocol | Port (s, L, H) | Eth0 | Eth1 | Action |
|------------------|----------------|-------------------------------------|-------------------------------------|--------|
| TCP | | | | |
| AlphaNet Data | 9000 | <input checked="" type="checkbox"/> | <input checked="" type="checkbox"/> | Delete |
| AlphaNet | 8000 | <input checked="" type="checkbox"/> | <input checked="" type="checkbox"/> | Delete |
| AlphaNetcom | 5010 | <input type="checkbox"/> | <input type="checkbox"/> | Delete |
| HTTP | 80 | <input checked="" type="checkbox"/> | <input checked="" type="checkbox"/> | |
| HTTPS | 443 | <input type="checkbox"/> | <input type="checkbox"/> | |
| IP Services | 8000 | <input checked="" type="checkbox"/> | <input checked="" type="checkbox"/> | Delete |
| Multimodule Data | 8010 | <input checked="" type="checkbox"/> | <input checked="" type="checkbox"/> | Delete |
| OPC Server 1 | 8110 | <input checked="" type="checkbox"/> | <input checked="" type="checkbox"/> | Delete |
| OPC Server 2 | 8110 | <input checked="" type="checkbox"/> | <input checked="" type="checkbox"/> | Delete |
| SSH | 22 | <input checked="" type="checkbox"/> | <input checked="" type="checkbox"/> | Delete |
| UDP | | | | |
| SIP | 5060 | <input checked="" type="checkbox"/> | <input checked="" type="checkbox"/> | Delete |
| VoIP Audio | 8100-8150 | <input checked="" type="checkbox"/> | <input checked="" type="checkbox"/> | Delete |

Showing 1 to 12 of 12 entries

Configuration File

| Configuration File | Last Saved | Last Applied |
|--------------------|---------------------|---------------------|
| xxx_0_config.xml | 2016-10-27 18:44:23 | 2016-04-22 04:40:52 |

Apply

AlphaPro

- Click the **Exchange & System** icon
- Select the multi module exchange from the list
- Click the **System** button
- Select **Eth1** as the **Default VoIP Port** and check the **Address**
- Enter the IP address of the slave modules.

Exchange Name: Node Type: AlphaNet - Adm. Here

Description: Language: DMP File ID

Node: DataBase Version:

Cluster Node:

PC Settings / TCP/IP Configuration

Baud Rate: Com Port:

Use TCP/IP to connect Connect to port:

Eth0 Eth1

Default VoIP Port

Address:

AlphaNet

1st Slave IP:

2nd Slave IP:

3rd Slave IP:

- ① **Only the Master Module supports serial port drivers and other central equipment and licenses like RIO, Paging, AlphaNet, SIP trunk node and SIP Registrar Node.**

8 External Communication

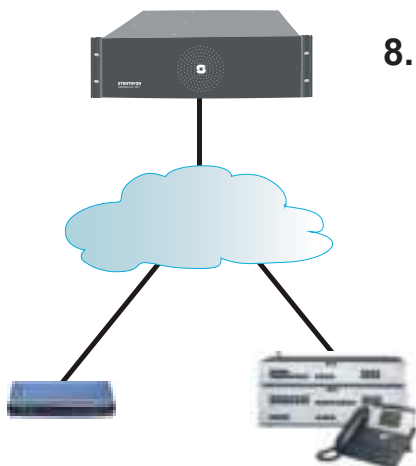

8.1 SIP Trunk License

The SIP Trunk License makes it possible to connect AlphaCom XE directly to iPBXs over IP networks. SIP trunks provide seamless integration between AlphaCom XE and other telecom systems supporting advanced functions like 'see who is calling' and shared numbering plans.

The SIP license is tested and verified for several SIP systems on the market. Please contact STENTOFON Support to get the latest list of verified equipment and systems.

The license will operate on all STENTOFON AlphaCom XE systems and upgraded AlphaCom systems.

8.2 Gateway Configuration

This section describes the setup of the AlphaCom XE system with AudioCodes MP-114/118 SIP Gateway, firmware version 5.4 and 5.6. The most common features used in an AlphaCom/AudioCodes interconnection are covered.

A full description including AudioCodes programming is found in the *SIP Gateway Configuration Guide A100K10333* and in *AlphaWiki* under the *SIP* category.

See also the *SIP GSM Gateway Configuration Guide A100K10390*.

The configuration of AlphaCom XE with the SIP gateway includes the following steps:

- Using AlphaWeb
 - Assign IP address to the AlphaCom Ethernet port
 - Insert SIP Trunk licenses
 - Firewall (filter) settings
- Using AlphaPro
 - Create a SIP Trunk Node
 - Define the AlphaCom/SIP routing
 - Create prefix numbers
 - Update the exchange

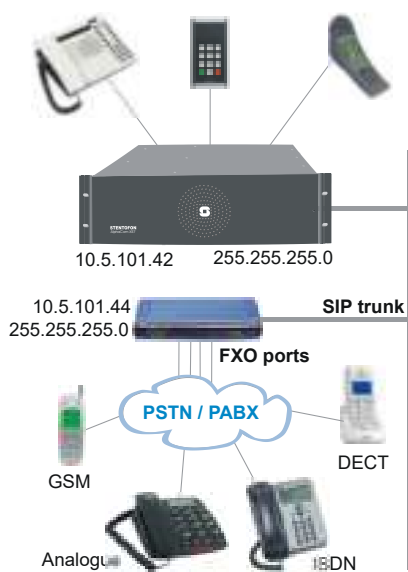

8.3 AlphaCom Configurations

8.3.1 AlphaWeb Configurations

Assign IP address to the AlphaCom E Ethernet port(s)

- Log on to AlphaWeb and select **System Configuration > Interfaces**
- Enter a valid IP address on the Ethernet port.

In the example below, Ethernet port 1 is used. Consult your network administrator to obtain the IP address.



8.3.2 Insert SIP Trunk licenses

- Log on to AlphaWeb and select **System Configuration > Licensing**
- Install the SIP Trunk license by clicking **Insert new License Key**



8.3.3 Firewall (filter) settings

- Log on to AlphaWeb and select **System Configuration > Filters**
- Enable the **SIP** protocol and **VoIP Audio** on the desired Ethernet port by ticking the relevant checkboxes (default enabled for Ethernet port1).



8.4 AlphaPro Configuration

8.4.1 Create a SIP Trunk Node

- From the AlphaPro main menu, click the '+' button next to the **Select Exchange** drop-down list to create a new exchange.
- The exchange **Type** must be set to **SIP Node**.
- Click the radio-button for **SIP Trunk Line** and enter 10.5.101.44
 - The SIP Trunk IP address must be identical to the IP address of the SIP Gateway.

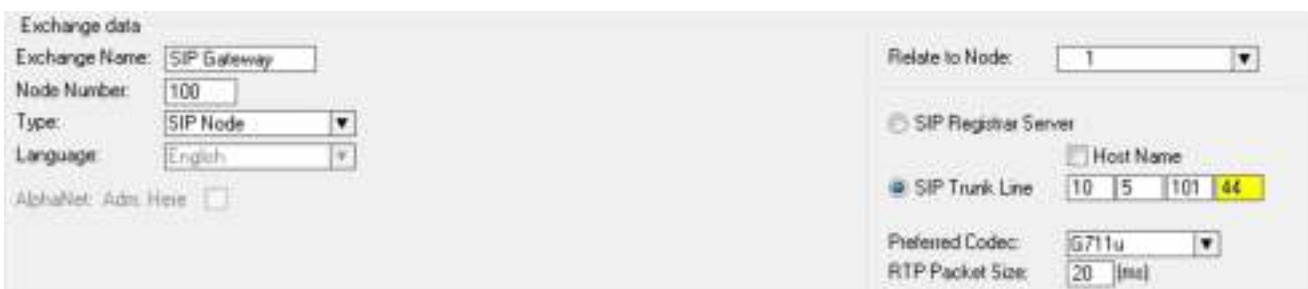

- ① *If AlphaCom is configured with a SIP Registrar node in addition to the SIP Trunk node, the SIP Registrar node must have a lower node number than the SIP Trunk node.*

8.4.2 Define the AlphaCom/SIP routing

- Select **Exchange & System > Net Routing** and click the **Insert** button to create a route between AlphaCom and SIP Gateway.
- Select **SIP Link** from the **ACDP Link** drop-down list
- Tick the **Audio on IP** checkbox
- Set **Preferred codec** to **G711u** and **RTP Packet Size** to 20 ms.
- Confirm by clicking **OK**

| | | |
|--------------|--|--|
| Service | Feature: <input type="text" value="083"/> AlphaNet | Display: <input type="text" value="SIP Gateway"/> SIP Trunk |
| Display Name | <input type="text"/> | Parameter 1: <input type="text" value="25"/> Parameter 2: <input type="text"/> |
| Feature Name | To enable the SIP trunk gateway in the network mode. | |
| Node | ACD: <input type="text" value="100"/> <input type="text"/> | Number: <input type="text"/> |
| Feature | Display Number: <input type="text" value="0"/> <input type="text" value="083"/> <input type="text" value="SIP Gateway"/> | |

8.4.3 Create Prefix number

The directory number (prefix) used to access the telephone line must be programmed in the AlphaCom directory table with **Feature 83**

- Click the **Directory & Features** icon
- Select *Global Number for AlphaNet – 83* from the **Feature** drop-down list
- Click **Insert**
- Enter the **Node** number for the SIP Trunk node (100 in this example)
- Enter the **Directory Number** for the SIP trunk
 - In this example, the default directory number 0 has been modified to be used as a prefix.
- Enter a **Display Text**
- Confirm by clicking **OK**

| Dir No | Display Text | Feature No |
|--------|----------------|------------|
| 792 | ProgOnOff | 82 / 0 |
| 794 | Global no | 83 / 1 |
| 0 | Telephone | 83 / 100 |
| 1000 | SIP Phone 1000 | 83 / 101 |
| 9001 | Glob Grp 1 | 84 / 1 |
| 9002 | Glob Grp 2 | 84 / 2 |
| 9003 | Glob Grp 3 | 84 / 3 |
| 9004 | Glob Grp 4 | 84 / 4 |
| 9005 | Glob Grp 5 | 84 / 5 |
| 9006 | Glob Grp 6 | 84 / 6 |

Feature: 083

Node: Parameter 2:

Directory Number:

Display Text:

Hide In Station Display (INFO)

8.4.4 Update the exchange



- Log on to the exchange by clicking the **Communication** icon
- Update the exchange by clicking the **SendAll** button.
- Reset the exchange after the send operation is completed.

8.5 Billing System

The VINGTOR Billing application makes it possible to manage and administer the communication fees and expenses for your VINGTOR ACM system. The application provides access authorization to external communication. The calling users will be identified based on PIN or subscriber number. Each user will have a set of authorization criteria such as credit line, and trunk type, which determines if he/she will be granted access to external communication.

The VINGTOR Billing application is a full billing system which allows you to generate revenues from your VINGTOR system and to administer a set of billing scenarios. Fees can, for instance, be calculated based on carrier type, duration, called number, and time of day. Billing of users can be done either by pre-paid or post-paid payment methods.

The application has a user-friendly web interface, making the job of the billing administrator much easier. The administrator can use a standard web browser to log into the system. From the web browser, the administrator is able to:

- Print billing invoices
- Print and view usage reports
- Change billing setup

Five different product versions of the Billing System are available with capacity from 2 to 32 external trunk lines, all catering to a maximum of 400 users.

See the manual *A100K10590 Billing System Configuration Guide* for further information.

The screenshot displays the 'VINGTOR Billing Administration' web interface. At the top, there is a navigation menu with tabs for USER, EXTENSION, SERVICE ACCOUNT, TRUNK, BARRING, FEE, LOG, INVOICE, and SETUP. Below the menu, the page title is 'You are here: Extension' and there is a search bar for 'Search Extension or Description'. The search results are displayed in a table with the following columns: Extension, Description, Staff Access, Assignment, and Trunk Access Group.

| Extension | Description | Staff Access | Assignment | Trunk Access Group |
|-----------|-----------------------|--------------|--------------------------------|----------------------------|
| 101 | Bridge Port Side | Assigned | User: Captain Griffin | 10 - Trunk Access Group 10 |
| 102 | Bridge Port | Assigned | User: First Officer Harkiss | 1 - Trunk Access Group 1 |
| 103 | Bridge Starboard Side | Assigned | Service: Bridge | 1 - Trunk Access Group 1 |
| 104 | Hallway #1, 1st Deck | Assigned | User: Chief Purser Patterson | All |
| 105 | Hallway #2, 1st Deck | Assigned | User: Chief Purser | 1 - Trunk Access Group 1 |
| 106 | Hallway #1, 2nd Deck | Assigned | Service: Hallway | 2 - TA Group 2 |
| 107 | Hallway #2, 2nd Deck | Assigned | Service: Dining Room | None |
| 108 | Hallway #3, 2nd Deck | Assigned | User: Brian Barney | None |
| 109 | Engine Room #1 | Assigned | User: Chief Engineer Bell | 1 - Trunk Access Group 1 |
| 110 | Engine Room #2 | Assigned | User: Second Engineer Ferguson | None |

At the bottom of the interface, there are buttons for 'Add Extension' and 'Remove Extension', and a footer with the VINGTOR logo and copyright information: '© 2012 VINGTOR Inc. All Rights Reserved'.

9 Audio Messaging

The Audio Messaging features are used to provide various messaging services and PA broadcast in the AlphaCom XE Audio Server. The messages are pre-stored in flash memory on the main processor board and can be played back to individual stations or a group of stations to provide information such as:

- Voice guidance at doors and elevators
- Security voice response
- Auto-attendant and voice guidance
- Information messages
- Alarm and evacuation messages

There are four ways to implement audio messaging services in the AlphaCom XE:

- ASVP software module
- ASVP board
- Upload customized WAV files from AlphaWeb
- Record customized messages from an intercom station

ASVP = AlphaCom Stored Voice Playback

9.1 Stored Voice Messages

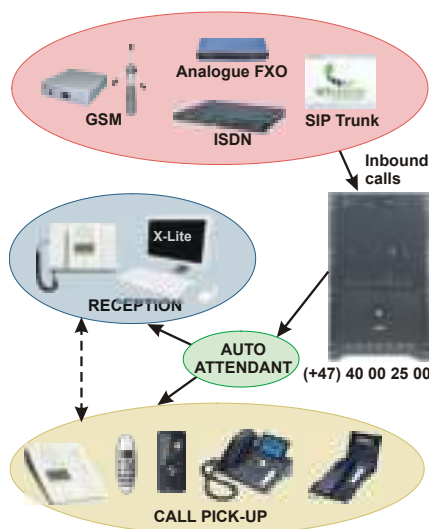

Both the Basic and the Enhanced Audio Messaging licenses have the capability of storing and playing audio messages from the Alphacom XE server. The feature set of the license is compatible with that of the ASVP board but offers some important additional functionalities.

The audio messaging license offers a broad set of applications and functions, some of which are:

- Live PA and group call broadcast with recall for handling feedback and verifying messages
- Pre-stored PA and group call broadcast
- Scheduled or event-based PA and group call broadcast
- Auto-attendant with voice guided menus for handling incoming calls
- Voice response for 'call request waiting' messages and absence messages
- Integration with 3rd party systems via OPC, STENTOFON SDK and STENTOFON Data Protocol

When the Audio Messaging license is activated, the Alphacom XE server will have a set of default messages such as absence, alarm and general information messages. The default messages can be changed and new messages can be added. Both new and modified messages can be recorded from an intercom station or created on a PC. Your favorite audio and music programs can be used to create these messages, which can then be uploaded to the Alphacom XE server via AlphaWeb.

The audio messaging license comes in three versions – Basic, Enhanced, and PA Recall. The licenses are different in terms of:

- Audio storage capacity
- Set of default audio messages
- Interactive complex message generation (Enhanced License only)
- Compatibility with hardware versions

9.1.1 Message identification

Stored Voice Messages are reached by a combination of two numbers: Message Group and Group Index.

The AMCD application uses this reference as the starting point when a message shall be played back. The same references are used for display texts to be looked up from the Message Description File.

9.1.2 ASVP software module

The ASVP module and the ASVP board support composing a voice message in run-time by using sequences of voice files and also composing parameterized messages.

Parameterized messages can be used to pronounce numbers, dates and times from the SW control. A Message Group/Index reference will result in playback of a sequence of WAV files

A set of standard audio messaging services can be implemented by uploading a language package file to AlphaCom XE using the web interface, AlphaWeb. The standard messages comprise:

- Absence messages
- Information messages
- Help messages
- Alarm messages

The types of messages that actually become available depends on the installed Audio Messaging license.

Install language package

The language file has the format **asvp_xx_06.00.apkg**, where **xx** is the actual language and **06.00** is the version number.

Before the installation can start, you need to download the language file from Zenitel's support websites **AlphaWiki** or **Partnetnet** to your PC.

- In AlphaWeb, select **System Maintenance > System Upgrade**
- Click **Browse** to choose the language file and click **Upload**
- Click the **Install** button

The messaging services becomes available immediately after the installation. No reset is required.

①

Note that:

- It is only possible to install a single ASVP package at a time.
- When installing a new version of the same package, just install over the old one.
- When installing a different ASVP package, delete the old ASVP package first.

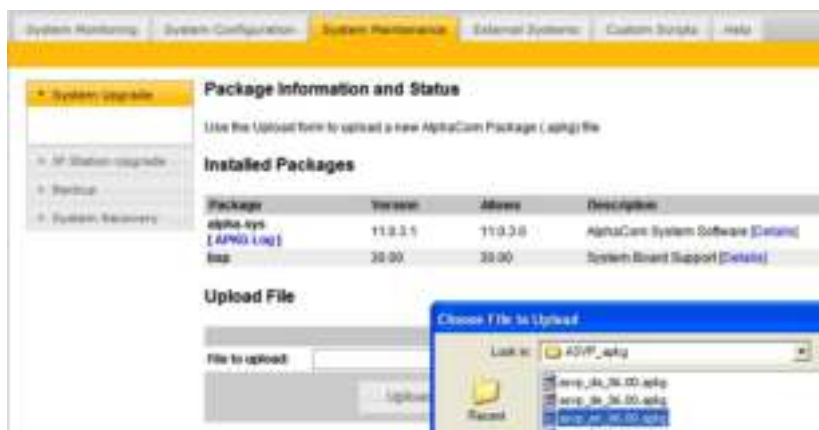

9.1.3 ASVP board

The ASVP board has been discontinued and replaced by the ASVP Software Module.

The ASVP board has the same set of standard messages as the ASVP Software Module.

No configuration is required when the ASVP board is used. Insert the board in any free board position in the AlphaCom server and the messaging services will be automatically activated when the system is powered up.

① **The ASVP board does not require any license.**

9.2 Customized Message Upload

The ASVP software module provides the AlphaCom XE server with a set of default messages such as absence, alarm, and general information messages.

It is possible to modify or add new messages to the system by uploading audio files to the AlphaCom XE server using AlphaWeb.

- If the ASVP Software Module is present, a web loaded message will mask the corresponding ASVP message.
- Deleting the web loaded message will unmask the ASVP message.

An Easy Message is one single WAV file for each Message Group + Group Index.

- Web loaded messages are uploaded individually via AlphaWeb
- Station-recorded messages are recorded from a station

The audio file can be recorded on a PC or in a professional studio if high quality playback is required. The audio file must be in WAV format.

The following codecs are supported:

- PCM files at 16kHz sample rate (linear 16bit), mono (1 channel)
- MS ADPCM at 16kHz sample rate, mono (1 channel)
- IMA ADPCM at 16kHz sample rate, mono (1 channel)

When a request is made to AlphaCom XE to play a message, it will search for matching group/index in the following order:

1. Station-recorded message
2. Web loaded message
3. Message in the ASVP Software Module on the AMC-IP board
4. Message on the ASVP board (if present)

9.2.1 Upload messages from AlphaWeb

When uploading a WAV file, the file must be associated with the relevant intercom feature by means of two parameters: **Message Group** and **Group Index**.

In the tables below, you can find the link between the intercom feature and the Message Group and Group Index for the message you intend to customize.

- Log on to AlphaWeb
- Select **System Configuration > Messaging**
 - An Audio Messaging license must have been installed up front to be able to access this page.
- Go to the **Upload Wav File** section at the bottom of the page, and select **Message Group** and **Group Index** according to the tables below.
- Browse to the WAV file, and select **Upload**.

Available language packages:

| | |
|-----|-----------|
| da | Danish |
| de | German |
| en | English |
| fi | Finnish |
| fr | French |
| it | Italian |
| ko | Korean |
| no | Norwegian |
| sv | Swedish |
| chn | Chinese |
| nl | Dutch |

The file will now be renamed and stored on the flash memory on the AMC-IP card.



Example:

svp_030_001.wav
is group 30, index 1,
(Alarm message 8191).

The file name will be renamed to **svp_ggg_iii.wav** where **ggg** is the Message Group number and **iii** is the Group Index number.

- Select the **System Configuration > Messaging** page to see and listen to all uploaded WAV files. Any file may be deleted.

There are no restrictions on the messages that can be uploaded but the message is checked against the installed Audio Messaging license to see if it is available for playback.

The most relevant English messages are listed below.

VOICE GUIDANCE AND INFORMATION MESSAGES

| Dir. no. | Feature | Message Group | Group Index | Default English ASVP message | Minimum license required |
|------------|-------------------|---------------|-------------|--|--------------------------|
| 9550 | Auto-attendant | 11 | 1 | | Basic: 1 Enhanced: 3 |
| 622 or 623 | Send Call Request | 10 | 47 | "Your call is registered, please wait" | None |
| 70 | Station reset | 10 | 42 | "No messages" | None |

ALARM MESSAGES

| Dir. no. | Feature | Message Group | Group Index | Default English ASVP message | Minimum license required |
|----------|-----------------|---------------|-------------|---|--------------------------|
| 8191 | Alarm Message 1 | 30 | 1 | "Fire alarm. Please stay calm and leave the building through the nearest exit. All exits are marked with green light. Don't stop, but proceed completely out of the building. Wait for further information outside." | Basic |
| 8192 | Alarm Message 2 | 30 | 2 | "The situation is now under control, the building can again be used. We are sorry for the inconvenience." | Basic |
| 8193 | Alarm Message 3 | 30 | 3 | "An unexpected situation has occurred. Please stay calm and leave the building through the nearest exit. All exits are marked with green light. Don't stop but proceed completely out of the building. Wait for further information outside." | Basic |
| 8194 | Alarm Message 4 | 30 | 4 | | Enhanced |
| 8195 | Alarm Message 5 | 30 | 5 | | Enhanced |
| 8196 | Alarm Message 6 | 30 | 6 | | Enhanced |
| 8197 | Alarm Message 7 | 30 | 7 | | Enhanced |
| 8198 | Alarm Message 8 | 30 | 8 | | Enhanced |
| 8199 | Alarm Message 9 | 30 | 9 | | Enhanced |

9.2.2 Record message from a station

It is possible to modify or add new audio messages from a Super User station. The default directory number for the recording function is **8180**.

The best result is achieved by using a station with handset for the recording.

Recording procedure:

- Dial **8180 + the directory number** of the feature that you want to modify
 - If a message already exists, the message will be played back.
 - If the message is a station-recorded message, it has to be deleted by pressing digit **0 + M-key** before a new message can be recorded
- Press the **M-key** to start recording.
 - Each M-key press starts a new recording
- Release the **M-key** to stop recording
 - The recorded message is played back
- Press **digit 7** to listen once more to the message
- Press **digit 8** to store the message
- Press the **C-key** to cancel the recording without storing the message

| SOME FEATURE EXAMPLES | | |
|-----------------------|---------------------|---|
| <i>Dial</i> | <i>Feature</i> | <i>Minimum license required</i> |
| 8180 + 9550 | Auto-attendant | Basic: 1 auto-attendant Enhanced: 3 auto-attendants |
| 8180 + 623 | Send Call request | None |
| 8180 + 70 | Station reset | None |
| 8180 + 8191-8199 | Alarm Message 1-9 | Basic: 3 alarm messages Enhanced: all alarm messages |
| 8180 + 771-779 | Absence messages | Enhanced |
| 8180 + 660-669 | Voice Mail messages | Enhanced |

A station-recorded message will mask any corresponding web-loaded message or ASVP message. When a station-recorded message is deleted, the web-loaded message will be unmasked if present.

A station-recorded message will be stored as a WAV file in the flash memory of the AMC-IP board and can be accessed from the **System Configuration > Messaging** page in AlphaWeb.

The WAV file will be stored with the file name **svp_ggg_iiaa_wav**, where **ggg** is the Message Group number, **iii** is the Group Index number and **a** indicates that it is a station-recorded message and not a web-loaded message.

You are only allowed to record messages according to the type of Audio Messaging license installed.

To be able to carry out station recording, the station must have access to features 111 and 114 in its Class of Service settings.

Example:

svp_030_001a.wav shows that this is a station-recorded message associated with group 30 and index 1. (Alarm message 8191).

9.2.3 Licensing

Playback of Stored Voice Messages stored on the AMC-IP board requires a license.

Usage of the ASVP board requires no license.

The license check is done on the Message Group/Index number at the time a message is requested for playback. Different message groups are used for different functions, hence, blocking per function as well as limiting the number of different messages for a function is possible.

Licenses does not limit the duration of single messages or the total duration of all stored messages.

Upload of Easy Messages and Station Recording features are not restricted by license. The ASVP module is also active without any license. The licensing only blocks the messages that can be used.

- **No license**
 - Only ASVP help messages are available (Message Group 10)
 - Standard ASVP messages by uploading ASVP Software Module
 - Record own customized messages
- **PA Recall license** (works on AMC-IP v. 10 or 11 hardware)
 - Delayed group call to prevent feedback
- **Basic Messaging license** (requires AMC-IP v. 11 hardware)
 - ASVP help messages (Group 10)
 - 1 Auto-Attendant message (Message Group 11, index 1)
 - 3 Voice Alarm Messages 8191-8193 (Message Group 30, index 1-3)
 - Recall function. Delayed group call to prevent feedback
 - Up to 2 Mbyte customized WAV files (Approx. 4 min. 16 sec. speech)
- **Enhanced Messaging license** (requires AMC-IP v. 11 hardware)
 - Unlocks all current messaging features
 - ASVP help messages (Message Group 10)
 - 3 Auto-attendant messages (Message Group 11, index 1-3)
 - Any number of Voice Alarm Messages (Message Group 30)
 - Up to 10 Mbyte of customized WAV files (Approx. 21 min. 20 sec. speech)
 - Recall function. Delayed group call to prevent feedback
 - Absence Messages (771 - 779)
 - Mail Messages (660 - 669)

9.2.4 Supported audio file formats

AlphaCom can only play back WAV container file format with 16kHz sample rate, single channel (mono), and one of the following three encodings

- PCM files at 16kHz sample rate (linear 16bit), mono (1 channel).
- MS ADPCM at 16kHz sample rate, mono (1 channel).
- IMA ADPCM at 16kHz sample rate, mono (1 channel)

PCM files need 32 KByte/s. The ADPCMs need 8 KByte/s (same as G.711/G.722)

Station-recorded Easy Messages are stored as IMA ADPCM.

9.3 Recall

The Recall function lets you record a message from a station and then dispatch the recorded message as a Group Call.

- The function is used to prevent feedback problems when making Group Calls
- The recorded message is stored temporarily
- It is deleted when the group call is finished
- The maximum duration of a single recall message is limited to 3 minutes
- The total system storage capacity for recall is approx. 40 minutes

9.3.1 Directory numbers

The default directory numbers for “recall” broadcast are:

- 9084: Recall to group 1 (all)
- 9085-9088: Recall to groups 2 - 5

- 9101: Recall to global group 1 (for AlphaNet)
 More recall numbers can be added from AlphaPro if required:

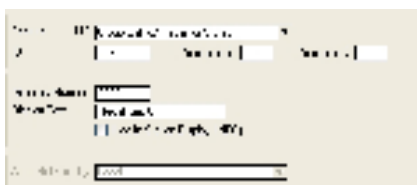

- In the **Directory & Features** window, select **Insert**
- Select **Group Call w/Recall - 113** from the **Feature** drop-down list
- Enter the local group number in the **ID** field
- Enter any free directory number and an appropriate display text in the **Directory Number** and **Display Text** fields.

The recall function can also be activated via a two-step operation using feature code 765:

- Dial 765 + group number.

9.3.2 User interface

Using the recall function from an intercom station

1. Dial the **recall number** (e.g. 9084 or 765+84)
2. Press the **M-key** to record a message
3. Release the **M-key** to listen to the recording
4. Press **8** to dispatch the message or:
 - Press the **M-key** to make a new recording
 - Press **7** to repeat the message
 - Press the **C-key** to cancel the message

Using the recall function from a telephone

1. Dial the **recall number** (e.g. 9084 or 765+84)
2. Press the ***-key** to record a message
3. Press the **#-key** to stop the recording and listen to the message
4. Press **8** to dispatch the message or:
 - Press ***** to make a new recording
 - Press **7** to repeat the message
 - **Hang up** to cancel

9.3.3 Optional settings

The recall user interface and the recall attributes can be altered by modifying parameter 2 (set in AlphaPro) of the recall directory number. By default, this parameter has value 0.

| RECALL OPTIONS | |
|-------------------|---|
| Value parameter 2 | Function |
| 1 | After playback to the group has finished, the group call and the initiator station will proceed to normal Group Call mode, and can use the M-key to talk into the group |
| 2 | If the initiator station disconnects during playback to the group, the message is terminated immediately |
| 8 | The initiator station will not listen to the playback to the group |
| 32 | The message is dispatched when pressing the C-key or hanging up (no need to confirm by pressing 8) |
| 128 | There will be no gong before the group call |
| 256 | The group is a global group call |
| 512 | There is no need to use the M-key during the recording |

Parameter 2 can be modified to change the recall user interface and different options can be combined.

Example:



If parameter 2 = 544 (i.e. 512+32), there will be no need to press the M-key to record and the message is dispatched when pressing the C-key. This option can be useful when using the recall function from telephones.

1. Dial the **recall number** (e.g. 9084)
2. Record message (no M-key)
3. Press the **C-key** or hang up to dispatch the message or:
 - Press **7** (or **#**) to stop the recording and listen to the message
 - Press the **M-key** (or *****) to restart a recording
 - Press **0** to delete the recording and cancel the operation

For two-step recall (i.e. 765 + group), the attributes are set in parameter 1 (ID) of the 765 feature code.

9.3.4 Simultaneous recall operations

Simultaneous recall operations are handled in the same way as for regular group calls.

Several recall operations can be active at the same time as long as there is no overlap in members of the simultaneous groups. If there is an overlap, the second recall operation will meet a busy signal.

There is a “Max Missing Members” setting per group in AlphaPro, which will let the second group call go through if the overlap is less than the number of stations specified.

Disable simultaneous group calls in AlphaPro

- Select **Exchange & System > System > Calls and Options**
- Disable **Simultaneous Group Calls** by unticking the checkbox
 - only one group call can be active at a time

Each group call can be assigned one out of four available **Setup Priority** levels.

With Simultaneous Group Calls

- A group call is canceled by a group call with higher priority if there is overlap between members.

Without Simultaneous Group Calls

- An ongoing group call is canceled by a group call with higher priority.

9.3.5 Hardware and software requirements

- **Hardware:** The recall function can be used on AMC-IP board versions 10 and 11 (red or black PCB).
- **Software:** Recall is available from AMC software version 11
- **License:** Recall requires an Audio Messaging license.

9.4 Auto-attendant

The Auto-attendant feature provides voice guided menus for handling incoming calls.

- Play a welcome message on incoming telephone calls
- Press a digit to re-route the call
- If no digits are pressed, the call will be automatically re-routed 5 seconds after the message has finished playing

The auto-attendant feature is also available for internal calls and is not restricted to external calls only.

9.4.1 Configuration

The default directory number for the auto-attendant feature is 9550.

Example:

"Welcome to Procom Ltd.
Press 1 for switchboard,
press 2 for Sales department,
press 3 for Marketing
department,
or wait for an answer"

Recording the message

- Dial **8180 + 9550** from a Super User station.
 - Press and hold the **M-key** while recording.
 - Release the **M-key** to listen to the message
 - Press **8** to save, or
 - Press the **M-key** again to make a new recording
- Alternatively, a WAV file can be uploaded from the web interface, AlphaWeb as described in section 9.2.1.

Digit routing

The Auto-attendant number 9550 uses the DAK table of physical station 500 for the "digit" actions.

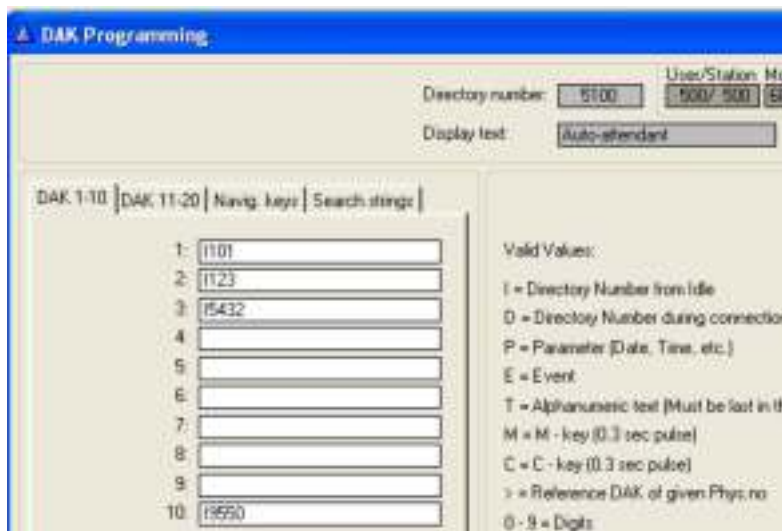

- In the **Users & Stations** window in AlphaPro, select physical number **500** in the list box and click **DAK**
- In the DAK table, enter the call destination for digit 1 to 9 (DAK 1-9), and digit 0 (DAK 10)

If the caller doesn't press any numbers within 5 seconds, the call is automatically routed to the entry in Search String 1.

In the Auto-attendant digit routing example shown, Digit 1 calls station 101, digit 2 calls station 123, digit 3 calls station 5432, and digit 0 repeats the voice menu

Adding more auto-attendant numbers

Up to 3 auto-attendant numbers are supported, depending on the license installed. Directory numbers for the first auto-attendant is included by default. For the second and third auto-attendants, you have to add new directory numbers from AlphaPro.

Adding a second auto-attendant:

In **Directory & Features**, click **Insert** and add a new number with the following properties:

| Dir. no. | Display Text | Feature | Parameter 1 (User no.) | Parameter 2 | Parameter 3 | Description |
|----------|----------------|---------|------------------------|-------------|-------------|--|
| 9551 | AutoAttendant2 | 105 | 0 | 2 | 501 | Auto-attendant number 2, using Stored Voice Message 2 and the DAK table of physical number 501 |

- To record a message, dial **8180 + 9551 + M-key**. Digit routing is done in the DAK table of physical number 501.

Adding a third auto-attendant:

- In **Directory & Features**, click **Insert** and add two new numbers with the following properties:

| Dir. no. | Display Text | Feature | Parameter 1 (User no.) | Parameter 2 | Parameter 3 | Description |
|----------|----------------|---------|------------------------|-------------|-------------|---|
| 8183 | MenuMsg3 | 111 | 11 | 3 | 0 | Stored Voice Message 3 |
| 9552 | AutoAttendant3 | 105 | 0 | 3 | 502 | Auto-attendant number 3, using Stored Voice Message 3, and the DAK table of physical number 502 |

- To record a message, dial **8180 + 9552 + M-key**
Digit routing is done in the DAK table of physical number 502.

9.4.2 Hardware and license requirements

- **Hardware:** The auto-attendant feature requires AMC-IP hardware version 8000/5 or 8000/6 (Black PCB).
- **License:** Auto-attendant requires a Basic (1 auto-attendant) or Enhanced (3 auto-attendants) Audio Messaging license.

10 System Monitoring

10.1 System Logging

The AlphaCom XE provides three types of logs.

- Debugging log
- System log
- Call statistics

Debug log

The debugging log includes low level system events that STENTOFON software engineers and support personnel use for troubleshooting.

System log

The system log provides technical events for monitoring the health of the AlphaCom system. The system log includes the following type of events:

- Board down
- Line error
- Device/card cage error
- AGA/AE1 line error
- System report
- Remote input on/off
- Customized event logging

In AlphaPro, it is possible to configure the events that should be included in the system log.



- Click the **Exchange & System** icon
- Click **System**
- Select **Logs and Errors**
- Select the events you want to be reported
- Confirm by clicking **OK**

It is also possible to configure customized events in the system log. This is done in AlphaPro by using Event programming.

Call statistics log

The call statistics log provides an event for each call in AlphaCom XE. The format of the call events are (valid from AMC SW 10.60):

Call ID ; Sec ; Call State ; From Node ; From DirNo ; From DispText ; To Node ; To DirNo (Collected digit SIP) ; To DispText ; Codec/rtp info

Open Call example:

The call has been in private ringing for 5 seconds, then 3 seconds of conversation.

```
000008 ; 5 ; Call Open ; Lab(11) ; 151 ; IP Station ; Oslo(3) ; 2561 ; John Brown ;
```

```
000008 ; 3 ; Call Open End ; Lab(11) ; 151 ; IP Station ; Oslo(3) ; 2561 ; John Brown ; g722 g722
```

AlphaCom XE can have many log destinations, allowing it to output emergency events to a specific destination and all information events to another.

For each log destination, it is possible to set up the type of log events (debugging log events, system log events, call statistics events) with priority level to be logged. In addition, it is possible to have a text filter to only output events containing a certain text string like *ALARM*.

The types of log destinations supported by AlphaCom XE are:

- SNMP trap
- Syslog server
- E-mail
- Local file
- Printer
- Console

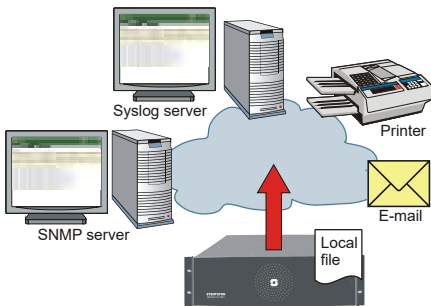

AlphaWeb is used to configure and set up the log destinations. Log into AlphaWeb:

- Select **System Configuration > Logging**
 - The list shows the log destinations and current configuration status.

Log Configuration

| Destinations | Status | Action |
|-------------------------|----------------|----------------|
| Local Filesystem | Configured | [Edit] |
| Local Serialport | Configured | [Edit] |
| Remote Syslog (UDP/TCP) | Configured | [Edit] / [Add] |
| E-Mail | Not configured | [Edit] / [Add] |
| SNMP Trap | Not configured | [Edit] / [Add] |

- The configuration may be altered as follows:
 - Click **[Edit]** to configure the destination
 - Click **[Del]** to delete the option
 - Click **[Add]** to create an additional item of the same type (e.g. two e-mail addresses)
- To configure, click **[Edit]** and fill in the dialogue box according to destination type.

Destination type: SNMP Trap
 IP Address: 10.1.2.107

Filters:

| Facility | Pri Level | Contains |
|---------------------|-----------|----------|
| Debug Log | Warning | |
| System Log | Info | |
| Call Statistics Log | Info | 2875 |

Save changes

- In the **Pri Level** drop-down list, select the lowest priority level for the different logs you want sent to the destination.
- Optional: Include a text filter to output events only containing a certain text string, e.g. *ALARM*
- Click **Save changes**
- Click **Generate test log messages** to test the log transmission

Log Test

Action: Generate test log messages

10.1.1 Local log file and AlphaWeb

AlphaWeb provides access to the local log file on AlphaCom. The following functions are provided via AlphaWeb:

- View Log
- Search Log
- Retrieve Log

View log

- Log in to **AlphaWeb**
- Select **System Monitoring > Logging**
- Select the log file to read
- Click **Submit**

View Log

| Select Log to read | Filename | Filesize | Last modified | Line count |
|---------------------|---------------------|----------|----------------|------------|
| AlphaStatistics.log | AlphaStatistics.log | 2.17 MB | May 3 13:40:02 | 16 |

| Start line | Step | View mode | Select Month | Select Day | Enter text |
|------------|--------|-----------|--------------|------------|------------|
| 0 | Submit | Reverse | | | Search |

```
13: May 3 13:40:02 src@AlphaCom_1 AlphaLog: : 000000 : 1 : Sr Call End : AMC 1(1) : 101 : SystemStat. : AMC 1(1) : 94 : AllCell :
14: May 3 13:40:01 src@AlphaCom_1 AlphaLog: : 000000 : 0 : Sr Call Start : AMC 1(1) : 101 : SystemStat. : AMC 1(1) : 94 : AllCell :
12: May 3 12:34:44 src@AlphaCom_1 AlphaLog: : 000007 : 1 : Sr Call End : AMC 1(1) : 101 : SystemStat. : AMC 1(1) : 94 : AllCell :
12: May 3 12:34:44 src@AlphaCom_1 AlphaLog: : 000007 : 0 : Sr Call Start : AMC 1(1) : 101 : SystemStat. : AMC 1(1) : 94 : AllCell :
11: Apr 30 12:46:57 src@AlphaCom_1 AlphaLog: : 000004 : 15 : Call Open End : AMC 1(1) : 102 : Svein Lindhjem : AMC 1(1) : 101 : SystemStat.
10: Apr 30 12:46:02 src@AlphaCom_1 AlphaLog: : 000004 : 0 : Call Open : AMC 1(1) : 102 : Svein Lindhjem : AMC 1(1) : 101 : SystemStat.
9: Apr 30 11:38:44 src@AlphaCom_1 AlphaLog: : 000008 : 1 : Call Open End : AMC 1(1) : 102 : Svein Lindhjem : AMC 1(1) : 101 : SystemStat.
8: Apr 30 11:38:43 src@AlphaCom_1 AlphaLog: : 000008 : 0 : Call Open : AMC 1(1) : 102 : Svein Lindhjem : AMC 1(1) : 101 : SystemStat.
7: Apr 30 11:38:32 src@AlphaCom_1 AlphaLog: : 000004 : 25 : Call Open End : AMC 1(1) : 102 : Svein Lindhjem : AMC 1(1) : 101 : SystemStat.
6: Apr 30 11:38:07 src@AlphaCom_1 AlphaLog: : 000004 : 0 : Call Open : AMC 1(1) : 102 : Svein Lindhjem : AMC 1(1) : 101 : SystemStat.
5: Apr 30 11:23:17 src@AlphaCom_1 AlphaLog: : 000003 : 42 : Call Open End : AMC 1(1) : 102 : Svein Lindhjem : AMC 1(1) : 101 : SystemStat.
4: Apr 30 11:23:04 src@AlphaCom_1 AlphaLog: : 000003 : 0 : Call Open : AMC 1(1) : 102 : Svein Lindhjem : AMC 1(1) : 101 : SystemStat.
3: Apr 30 11:19:10 src@AlphaCom_1 AlphaLog: : 000002 : 27 : Call Open End : AMC 1(1) : 102 : Svein Lindhjem : AMC 1(1) : 101 : SystemStat.
2: Apr 30 11:18:42 src@AlphaCom_1 AlphaLog: : 000002 : 0 : Call Open : AMC 1(1) : 102 : Svein Lindhjem : AMC 1(1) : 101 : SystemStat.
1: Apr 30 11:18:34 src@AlphaCom_1 AlphaLog: : 000001 : 11 : Call Open End : AMC 1(1) : 102 : Svein Lindhjem : AMC 1(1) : 101 : SystemStat.
0: Apr 30 11:18:13 src@AlphaCom_1 AlphaLog: : 000001 : 0 : Call Open : AMC 1(1) : 102 : Svein Lindhjem : AMC 1(1) : 101 : SystemStat.
```

Search log

To view a log, search the log by stepping through the log, or by date or text string search.

Retrieve log

When viewing the log, the hyperlink for the log file name may be selected to download the log to your PC.

10.1.2 System clock and event time stamps

To configure the system clock and event time stamps:

Time and Date

| Your Region | Local Time |
|-------------|---|
| Europe/Oslo | Sunday, 20th of June 2010 15:03:26 CEST |

Select New Region

| New Region | Select Your Zone |
|------------|------------------|
| | US |
| Submit | |

Set Localtime

| Date | Time |
|---------------|---------------------|
| New Date/Time | 20.06.2010 15:03:26 |
| Set Time | |

Configure Network Time Protocol (NTP) Server

| IP Address | |
|------------------------------|-----------|
| Configured server IP Address | 10.5.2.19 |
| New server IP Address | 10.5.2.19 |
| Test Server | |
| Set Server | |
| Get Time | |

Configuration File

| Configuration File | Last Saved |
|--------------------|---------------------|
| amc_ip_config.xml | 2010-04-26 09:35:04 |
| Apply | |

- Log in to **AlphaWeb**
- Select **System Configuration > Time and Date**
- Select the time zone from the **Select Your Zone** drop-down list
- Set the local time by entering values in the **Date** and **Time** fields, or enter the IP address to a Network Time Server in the **New server IP Address** field
- Click **Apply** to save changes

10.2 System Information and Statistics

AlphaCom XE provides access to important system status information and statistics from:

- SNMP MIBs
- AlphaWeb

SNMP definition:

Simple Network Management Protocol (SNMP) is a set of protocols for centralizing the management of IP networks.

It is used for both collecting information from and configuring the full range of network devices, including servers, printers, switches, hubs, routers, firewalls, wireless access points and individual workstations. A wide variety of information can be collected, ranging from a server's CPU usage level to its chassis temperature.

An SNMP device structures its records in a set of MIBs (Managed Information Base), where the SNMP MIB II includes information such as the node's CPU and memory status, active tasks, etc.

10.2.1 SNMP MIBs

AlphaCom XE support SNMP traps and SNMP MIB interface according to IETF standards. AlphaCom XE supports two MIBs. These are:

- SNMP MIB II
- SNMP AlphaCom MIB

The AlphaCom MIB includes information such as node status information and VoIP statistics. For a complete definition of the AlphaCom MIB, see the document *STENTOFON AlphaCom MIB*.

10.2.2 System information

AlphaWeb provides access to system status information and statistics.

- Log in to **AlphaWeb**
- Select **System Monitoring > Node Information**
- Click **Information** to see general system information, and SW and HW configuration
- Click **Processes** to see software state and versions

Information

| Information | Status |
|--|-------------------------|
| Node Name | AMC1 |
| Node Number | 1 |
| Operational | Enabled |
| Usage | Idle (0/250) |
| Current System Time | 15-12-25 |
| System Uptime | 32 days, 23:37 hours |
| AMC Uptime | 32 days, 23:37 hours |
| MAC Address | 00:60:35:03:23:D3 |
| Total Space (FLASH / DATA FLASH / RAMFS) | 26800 / 2048 / 10240 kB |
| Free Space (FLASH / DATA FLASH / RAMFS) | 4812 / 944 / 10012 kB |

SW Configuration

| Software | Release |
|---------------------------|-------------------------------|
| AMC System Package | Version 11.00.2.03 |
| AMC Board Support Package | Version 22.00 |
| Customer Database | Version 10.50(1092308/193408) |

HW Configuration

| Search: <input type="text"/> | | | | | | Display 15 records |
|------------------------------|----------------|------------|-------------|---------------|------------|--------------------|
| Module (CC) | Board Position | Board Type | Board State | Board Version | Board SBI | |
| Master (65) | 25 | AMC_3_00 | OPERATING | 11.0.9.2 | 4 x SBI_03 | |
| Master (65) | 01 | ASLT_0 | OPERATING | 03.00 | 1 x SBI_02 | |

Showing 1 to 2 of 2 entries

First Previous 1 Next Last

11 Upgrade & Backup

It is necessary to make a backup of the client data from AlphaPro before upgrading the software. This is performed by selecting **GetAll** from **AlphaPro** and storing the backup on the PC.

The backup from AlphaWeb or station can not be stored and retrieved from the AMC-IP's flash memory if the NVRAM or SW is upgraded to a newer version. AMC-IP will perform an automatic cold start and load default numbers, etc.

Backup from AlphaWeb or station (7820) is only possible if the client data is to be loaded back to the same NVRAM and SW versions.

11.1 Software Upgrade

AlphaCom has one AMC (AlphaCom Module Controller) system software package. This package is named:

alpha_sys_aa_bb_cc_dd.apkg

where *aa_bb_cc_dd* is the version number.

AMC System upgrade

To upgrade the AMC system package:

Package Information and Status

Use the Upload form to upload a new AlphaCom Package (.apkg) file

Installed Packages

| Package | Version | Allows | Description |
|--------------------------------------|------------|-----------|---|
| alpha-sys [APKG Log] | 11.00.2.03 | 10.01.1.0 | AlphaCom System Software [Details] |
| bsp | 22.00 | 22.00 | System Board Support [Details] |
| exchange-db-backup [APKG Log] | 01.01 | 01.01 | AlphaCom Database Backup Package [Details] |
| system-config-backup [APKG Log] | 01.01 | 01.01 | AlphaCom System Config Backup Package [Details] |

Upload File

File to upload:

- Log in to **AlphaWeb**
- Select **System Maintenance > System Upgrade**
- Click **Browse** to select the appropriate *.apkg* file
- Click **Upload** to transfer the AMC system package to AlphaCom
- Click **Install** to start the installation
① **AlphaCom XE will do an MD5 check to verify that the software package is valid. The MD5 digital signature is used to hinder possible virus infections.**

11.2 Configuration Backup and Restore

AlphaWeb provides an easy way to back up and restore the running configuration in the AlphaCom XE.

The procedure will perform a backup of the server database to the PC as an *.apkg*s file. Previous versions will be overwritten.

Use the System Upgrade menu to restore the *.apkg*s file

Backup

Include technical debug information

Backup File Information

| | Backup File | Running Database |
|--------------------------|------------------|------------------|
| Backup Type | Normal | -- |
| Created date | 2015-04-13 12:36 | -- |
| Created with AMC version | 1100 | 11.0.0.0 |
| Config DB Size | 1045410 | 1045410 |
| Config DB Version | 1100 | 1100 |

Free space: 4055 KB

Backup of running configuration

- Log in to **AlphaWeb**
- Select **System Maintenance > Backup**
- Click **Create Backup**
- Click the link **backup.bin** to download the backup file to your PC

Restore configuration from backup

- Log in to **AlphaWeb**
- Select **System Maintenance > System Upgrade**
- Click **Browse** to select the appropriate *.apkg*s file in the PC
- Click **Upload**

12 Appendix - Technical Data

12.1 Specifications

| AlphaCom Server | | | | | |
|-------------------------------|-----------------------|---|----------------------------------|-------------------------|--------------------------------|
| | Conditions | XE1 | XE7 | XE20 | XE26 |
| Dimensions, mm (W x H x D) | Rack mount | 332x44x340 | 427x133x380 | 483x265x365 | 483x841x365 |
| | Floor cabinet | - | - | - | 483x841x513 |
| | w. distribution field | - | - | - | 483x841x593 |
| Weight, Kg | Rack mount | 2.0 | 7.0 | 17.0 | 39.0 |
| | Floor cabinet | - | - | - | 46.0 |
| | w. distribution field | - | - | - | 53.5 |
| Mounting | | 19" rack | Wall, shelf or 19" rack | 19" rack | Floor cabinet or 19" rack |
| Input voltage | | 5 VDC | 24 VAC +/- 10% or 20 - 32 VDC | 90 - 270 VAC | 90 - 270 VAC or 20 - 60 VDC |
| Power consumption, W | Fully equipped | 4 | 260 max. | 450 (80 subscribers) | 580 max. |
| Temperature | Environment | -5 to +55°C - Recommended +20°C | | | |
| Humidity range | Non condensing | 10% to 90% RH | | | |
| Feature cards | Slot positions | 0 | 6 | 18 | 24 |
| Traditional intercom | Extensions, max. | 0 | 36 | 80 (102 physically) | 138 |
| Entertainment channels | On APC board | NA | 2 | 6 | 6 |
| | Per AGA board | NA | 6 | 16 | 16 |
| Remote control outputs | Per ASLT board | NA | 6, 12 on back plane | 6 | 6 |
| Remote control inputs | On APC board | NA | 2 | 6 | 6 |
| Serial port | COM0 | RS232, 9-pin D-sub | | RS232, RJ45 | |
| | COM1, RJ45 | RS232/422/485 | | | |
| Ethernet | 2 x RJ45 | 10/100 Mbps | | | |
| Traffic capacity | SIP trunks | 30 channels | | | |
| | VoIP AlphaNet | 30 channels | | | |
| | Digital trunks | | 32 channels | | |
| | Analog trunks | | 6 channels | | |
| IP protocols | | IP v4 - TCP - UDP - Telnet - FTP - NTP - HTTP1.1 - Syslog - SNMP v2c - SIP - RTP - RTCP -VoIP AlphaNet - STENTOFON data | | | |
| Audio technology | | High-Resolution 1-Bit Audio - High-Fidelity 40 Hz-18.5 kHz - Wideband 7 kHz (G.722) - Narrowband 3.4 (G.711) - Adaptive Jitter Buffers - Adaptive Time Synchronization | | | |
| EMC | Emission | EN 61000-6-3 and EN61000-6-4 EN 55022 (1994) + A1 (1995) + A2 (1997) | | | |
| | Immunity | EN 61000-6-1 and EN 61000-6-2 EN 55024 (1998) + A1 (2001) + A2 (2003) | | | |
| Safety / Approval | | CE FCC part 15 | CE EN 60950 | CE EN 60950 | CE EN 60950 |

① For more details on each AlphaCom XE server, see individual datasheets.

12.2 Physical Numbers

Each subscriber point in an AlphaCom XE server has a physical number. The number is determined by the board position and the type of module (master/slave).

There are 6 subscribers on each board of the Intercom board ASLT, Telephone board ATLB, and AGA board.

- Board in slot 1 has physical numbers 1-6
- Board in slot 2 has physical numbers 7-12
- Board in slot 3 has physical numbers 13-18, and so on.

Telephone board ATLB-12 has 12 subscribers on each board. The 6 first lines have physical numbers according to the insertion slot, while the 6 last lines have numbers with an offset of 276 to the 6 first numbers.

- Board in slot 1 has physical numbers 1-6 and 277-282
- Board in slot 2 has physical numbers 7-12 and 283-288
- Board in slot 3 has physical numbers 13-18 and 289-294, and so on.

Since card positions 2-7 are not used in XE20, the corresponding physical numbers are therefore missing.

| PHYSICAL NUMBER TABLE | | | |
|-----------------------|-----------|------------------------|-----------|
| AlphaCom modules | XE7 | XE20 | XE26 |
| Single or master | 1 - 36 | 1 - 6 143 - 138 | 1 - 138 |
| 1 st slave | 139 - 174 | 139 - 144 187 - 276 | 139 - 276 |
| 2 nd slave | 277 - 313 | 277 - 282 325 - 414 | 277 - 414 |
| 3 rd slave | 415 - 451 | 415 - 421 510 - 552 | 415 - 552 |

12.3 ASLT & AGA Board Positions

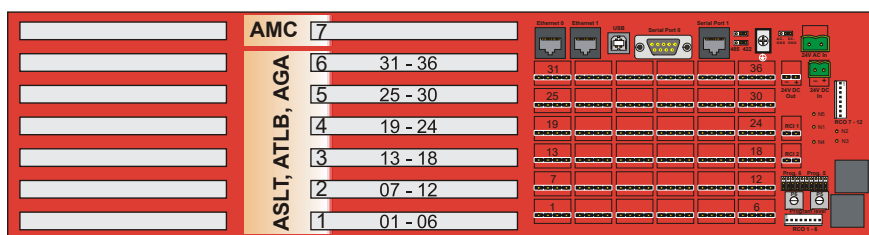

Board positions and physical numbers in AlphaCom XE7

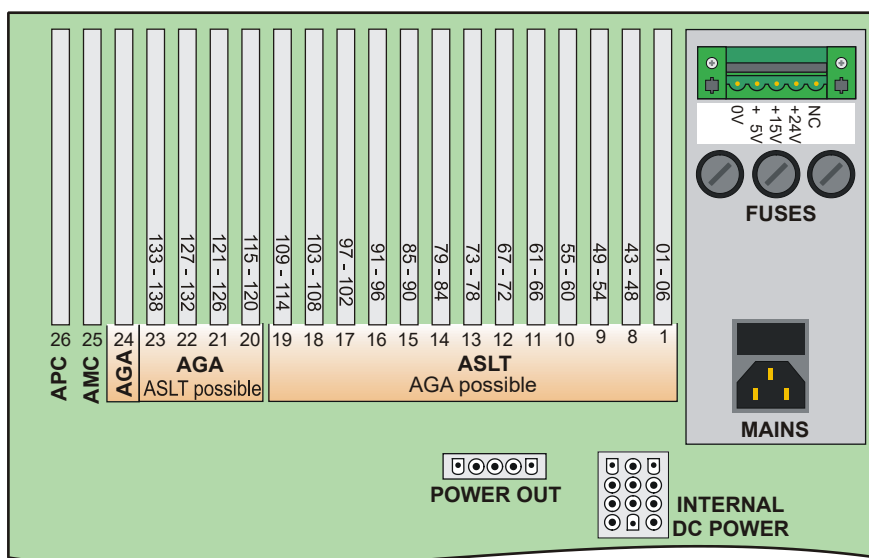

Board positions and physical numbers in AlphaCom XE20

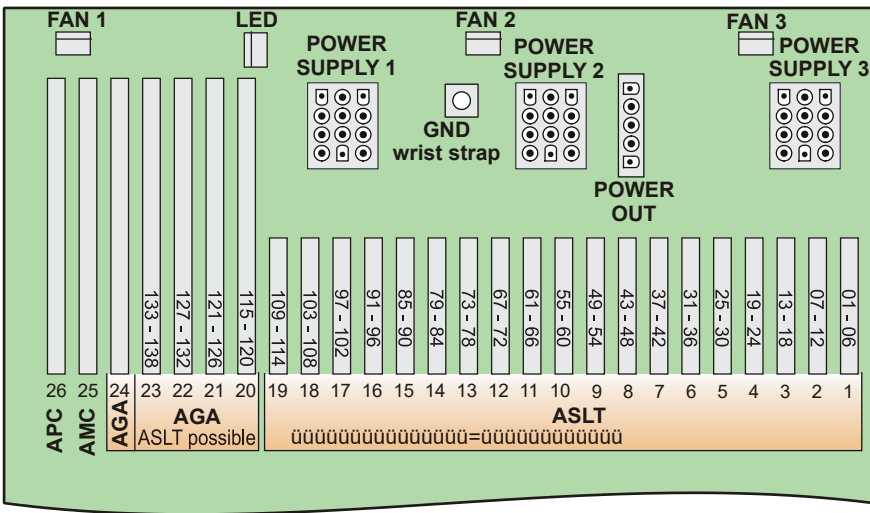

Board positions and physical numbers in AlphaCom XE26

12.4 Switches and Jumpers

12.4.1 AMC-IP

The AMC-IP version 11 board has two 8-bank DIP switches and four jumpers set to default positions at delivery.

ⓘ **Do NOT change the default settings unless you are absolutely sure of the consequences!**

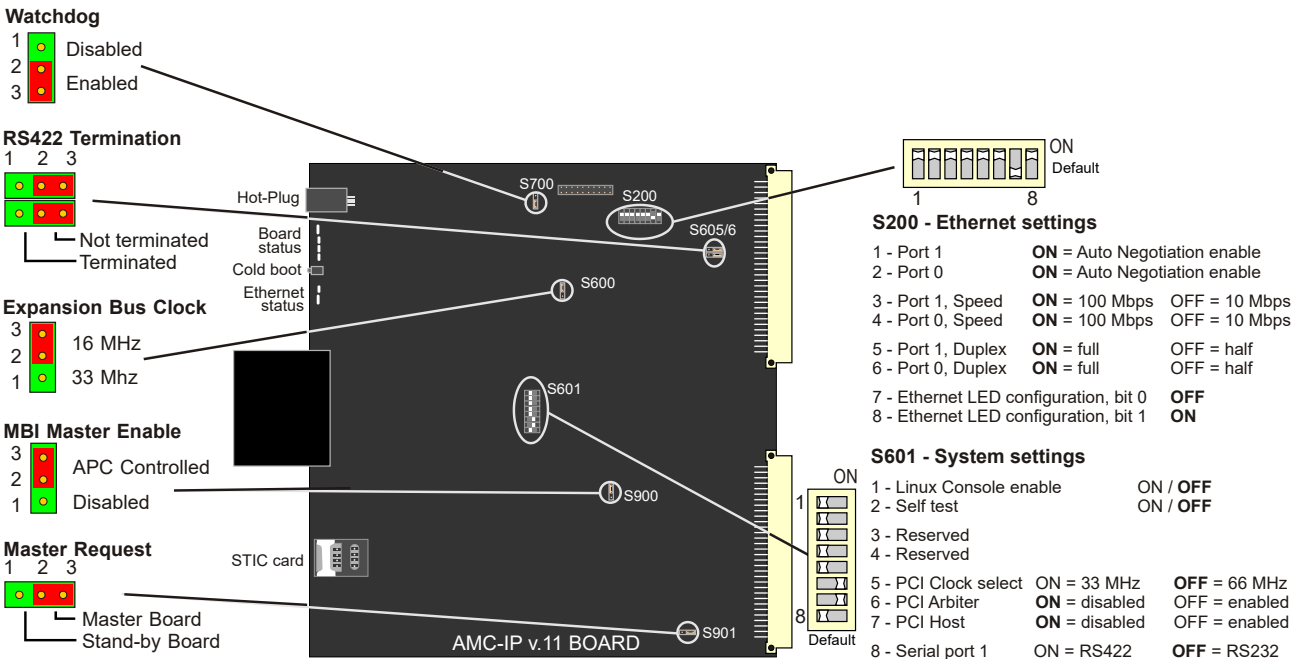

S200 settings

The switch S200 determines the Ethernet port speed, the duplex mode, and the link status LED mode.

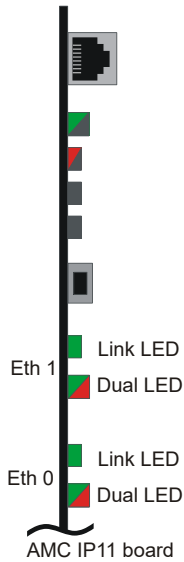

| SPEED / DUPLEX | | | | |
|----------------|-----------|-----------|-------------|-------------|
| S200-1/2 | S200-3/4 | S200-5/6 | Speed | Duplex* |
| OFF | OFF | OFF | 10 Mbps | Half |
| OFF | OFF | ON | 10 Mbps | Full |
| OFF | ON | OFF | 100 Mbps | Half |
| OFF | ON | ON | 100 Mbps | Full |
| ON | OFF | OFF | Auto | Half |
| ON | OFF | ON | 10 Mbps | Auto |
| ON | ON | OFF | 100 Mbps | Auto |
| ON | ON | ON | Auto | Auto |

* Full = Open duplex (telephone)
 Half = Voice controlled duplex
 Auto = Automatically sensed

| LINK STATUS FOR ETHERNET PORT 0 AND 1 | | | | | | | |
|---------------------------------------|-----------|------------------|----------------|--------------------|-------------------------|--------------------------|------------------------|
| S200 | | Link LED | | Dual LED | | | |
| 7 | 8 | Off | Green | Off | Green | Red | Amber |
| OFF | OFF | !0 Mbps | 100 Mbps | Link down | Half Duplex | Error | Full Duplex |
| OFF | ON | Link down | Link up | No activity | Rx activity | Tx activity | Tx+Rx act. |
| ON | OFF | 10 Mbps | 100 Mbps | Link down | Link up, Activity* | Full Duplex, Collisions* | Link up in full Duplex |
| ON | ON | 10 Mbps | 100 Mbps | Link down | Link up, MII isolation* | Full Duplex, Collisions* | Link up in full Duplex |

* Blink rate = 100 ms

12.5 Port Pin-Out

The AlphaCom XE servers have two serial and two Ethernet ports.

AlphaCom XE20/XE26

For AlphaCom XE20 and XE26, the serial ports are available as RJ45 connectors on the AMC-IP Filter Card.

- Serial Port 0 is set to RS232 only.
- Serial Port 1 is set to RS232 by default, but can be set to RS422 or RS485.
 - To set Serial Port 1 to RS422, set DIP switch S601-8 on the AMC-IP board to the ON position (see figure on page 64).
 - To set Serial Port 1 to RS485, set DIP switch S601-8 on the AMC-IP board to the ON position, as well as move the two jumpers on the AMC-IP Filter Card to the "RS485" position.

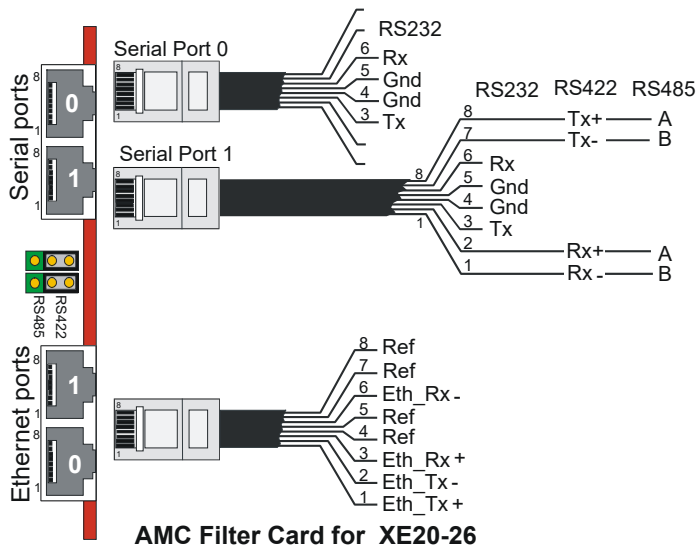

AMC Filter Card for XE20-26

AlphaCom XE7

For AlphaCom XE7, Serial Port 0 is on a 9-pin D-SUB connector and Serial Port 1 is on an RJ45 connector. These connectors are found on the AlphaCom XE7 backplane.

- Serial Port 0 is set to RS232 only.
- Serial Port 1 is set to RS232 by default, but can be set to RS422 or RS485.
 - To set Serial Port 1 to RS422, set DIP switch S601-8 on the AMC-IP board to the ON position (see figure on page 64).
 - To set Serial Port 1 to RS485, set DIP switch S601-8 on the AMC-IP board to the ON position, as well as move the two jumpers on the AlphaCom XE7 backplane to the “RS485” position.

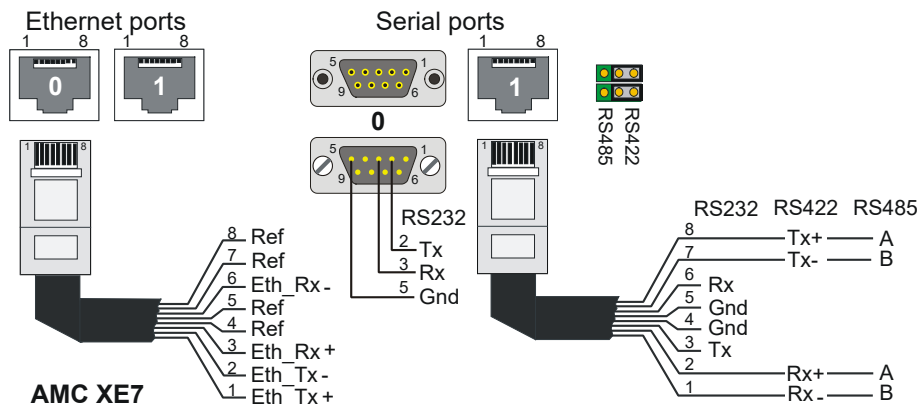

AMC XE7

AlphaCom XE1

The connections and pinouts are identical to that of AlphaCom XE7. The Ethernet and serial ports are located at the rear of the cabinet.

- Serial Port 0 is set to RS232 only.
- Serial Port 1 is set to RS232 by default, but can be set to RS422 or RS485.
 - To set Serial Port 1 to RS422, set DIP switch S601-8 on the AMC-IP board to the ON position (see figure on page 64).
 - To set Serial Port 1 to RS485, set DIP switch S601-8 on the AMC-IP board to the ON position, as well as move the two jumpers JP2 and JP3 on the AlphaCom XE1 motherboard to the position 2-3. To get access to the jumpers, you must remove the top cover of the XE1 server.

12.5.1 RIO controller unit connection

The signal to and from AlphaCom XE is taken from the RJ45 serial port 1, i.e. pins 1 and 2 if RS485 is used or pins 3 and 6 if RS232 is used. In the 15-pin D-SUB for the RIO Controller Unit, the pins 2 & 4 and 9 & 11 must be connected together.

The GND connection between AlphaCom and RIO in RS485 mode is normally not necessary. In general on RS485 links, the connection of a third wire (GND) between the source and receiver may be done to limit the common mode voltage that can be impressed on the receiver inputs. If you want to connect it, use pin 5 on the AlphaCom RJ45 port to pin 5 on the RIO 15-pin D-SUB. Programming is the same as with conventional AMC.

- ① Note that when using RS485, the switch S601-8 on the AMC-IP board must be set to the RS422 position, and two jumpers must be moved from the RS422 to RS485 position. The jumpers are located on the AMC-IP Filter Card for XE20 and XE26, and on the backplane of the XE7. On the XE1 you need to open the cover to access the jumpers.

Multidrop RS485 Cabling

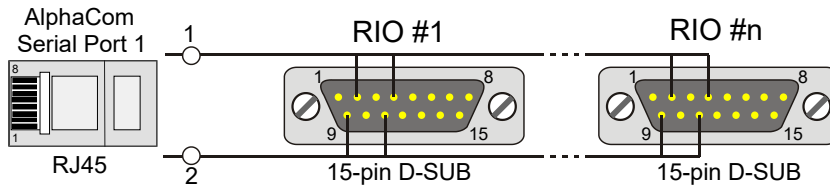

Point-To-Point RS232 Cabling

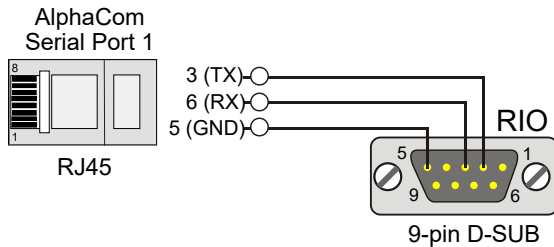

www.zenitel.com

Zenitel Norway AS
P.O. Box 4498 Nydalen
NO-0403 OSLO
Norway

DOC NO **A100K10805**

customer.service@zenitel.com



Zenitel and its subsidiaries assume no responsibility for any errors that may appear in this publication, or for damages arising from the information therein. STENTOFON and VINGTOR products are developed and marketed by Zenitel. The company's Quality Assurance System is certified to meet the requirements in NS-EN ISO 9001. Zenitel reserves the right to modify designs and alter specifications without notice. ZENITEL PROPRIETARY. This document and its supplementing elements, contain Zenitel or third party information which is proprietary and confidential. Any disclosure, copying, distribution or use is prohibited, if not otherwise explicitly agreed in writing with Zenitel. Any authorized reproduction, in part or in whole, must include this legend. Zenitel – All rights reserved.