



FPP-5000-TI

F.01U.073.324



BOSCH

cs Instalacní příručka
da Installationsvejledning
de Installationsanleitung
el Οδηγίες συναρμολόγησης
en Installation guide
es Guía de instalación
fr Manuel d'installation
hr Upute za instalaciju
hu Telepítési útmutató

it Guida di installazione
nl Installatiehandleiding
pl Instrukcja instalacyjna
pt Guia de Instalação
ro Ghid de instalare
ru Руководство по установке
sl Navodila za namestitev
sv Installationshandledning
tr Kurulum Klavuzu

FPP-5000

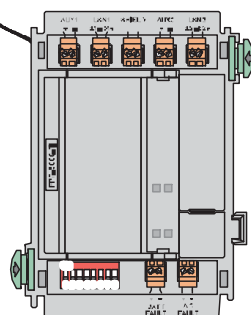
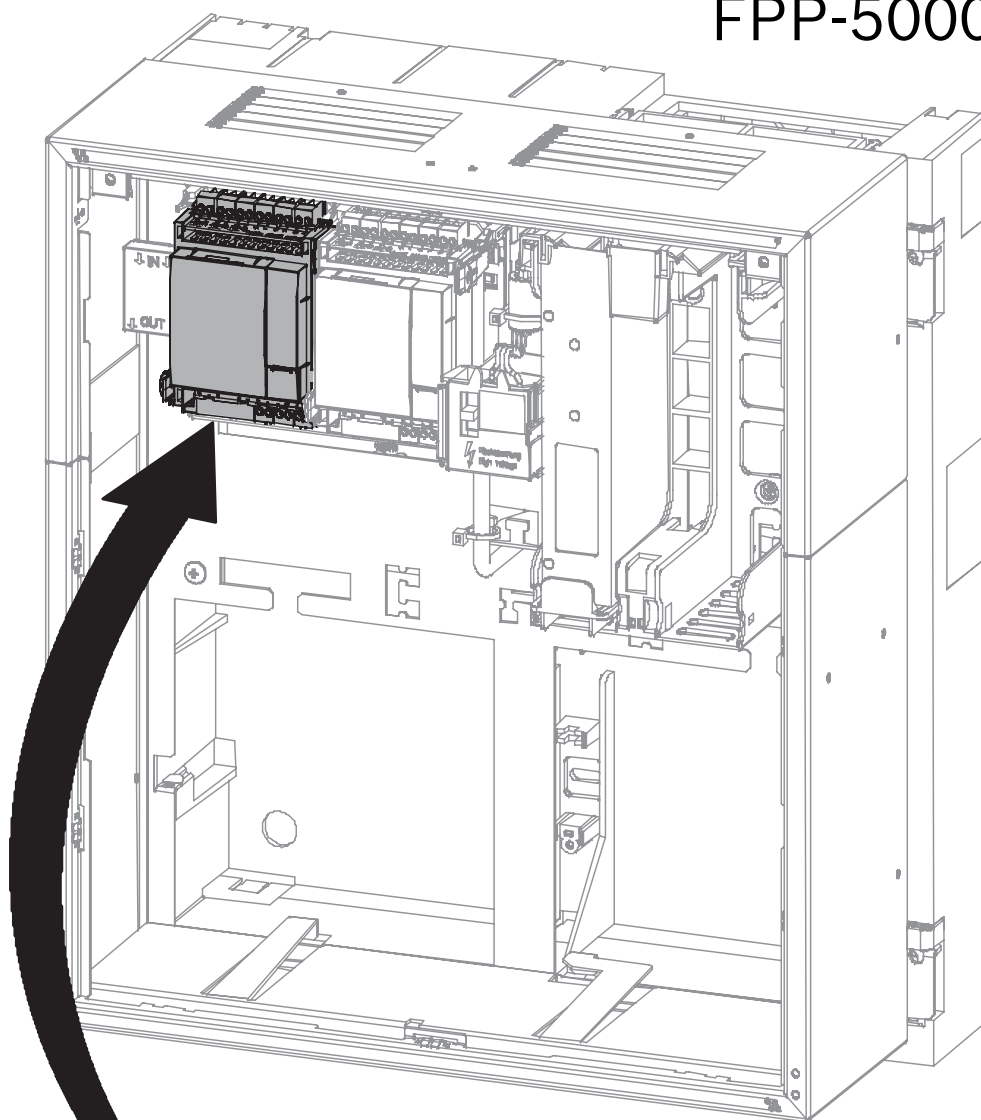

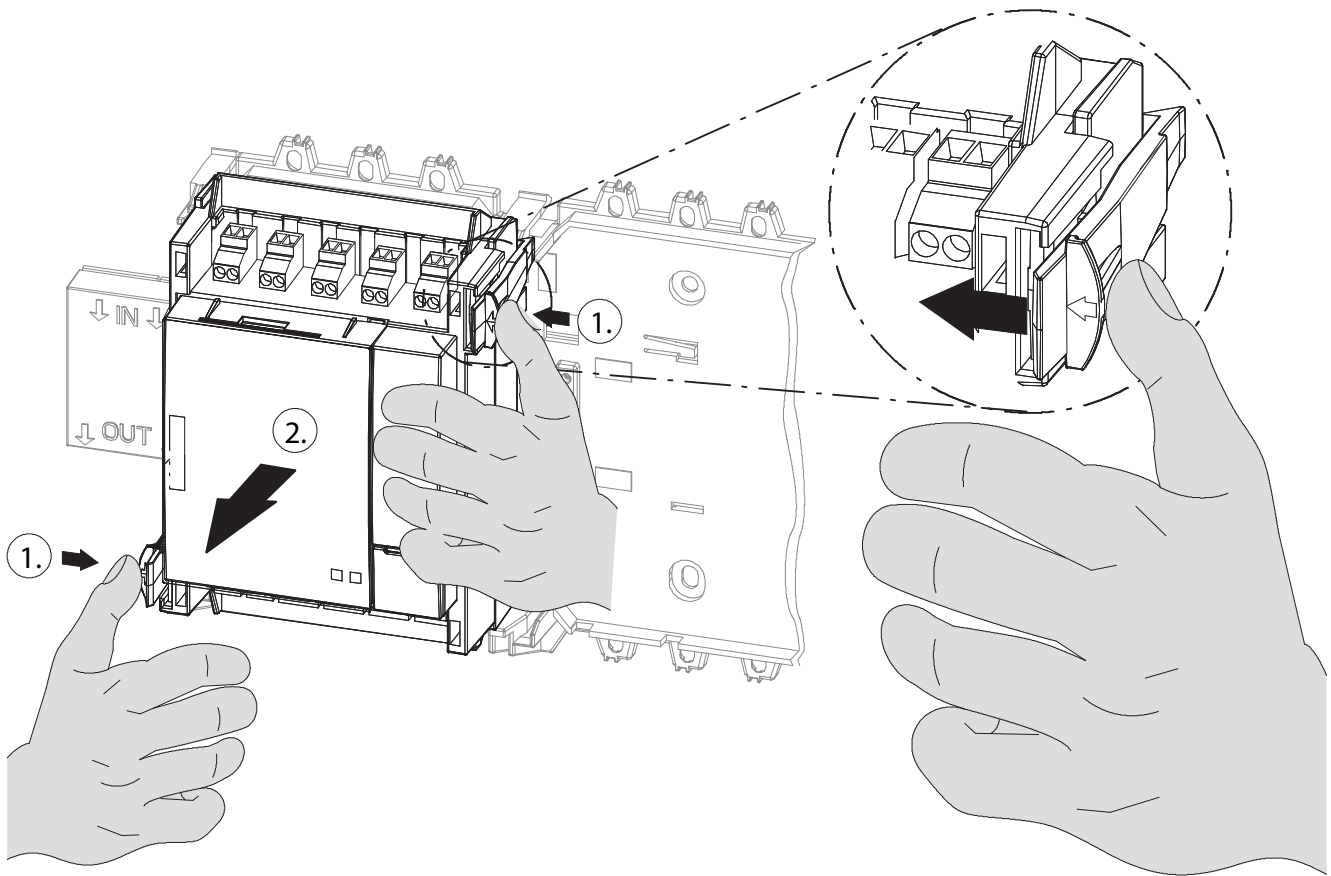
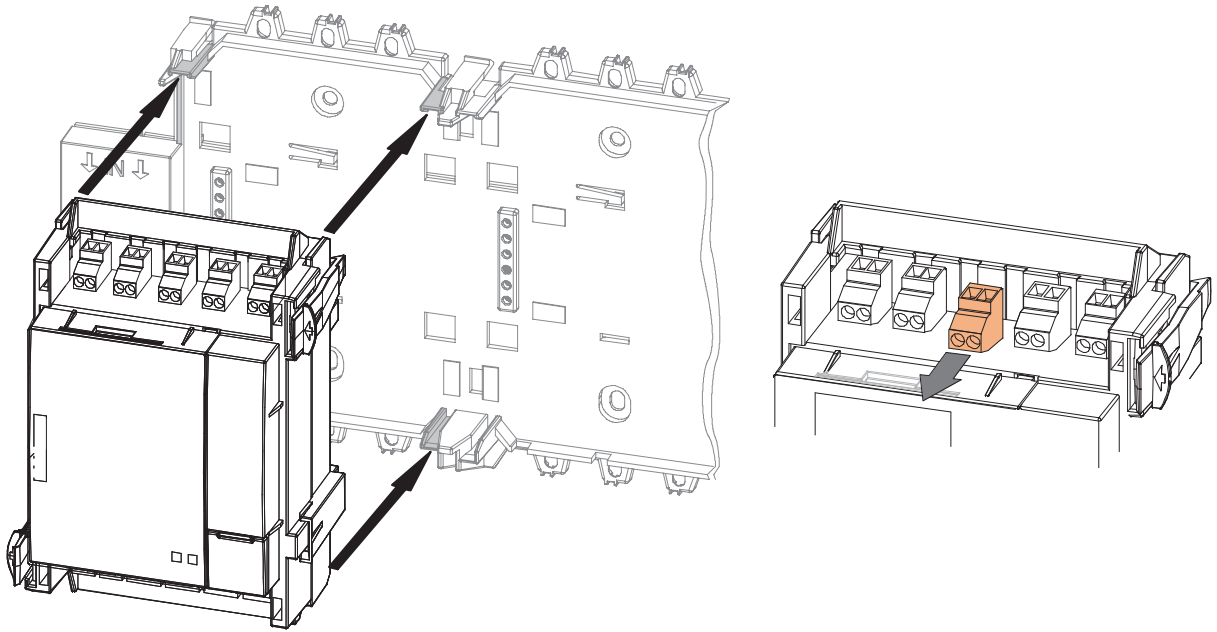

FPP-5000-TI

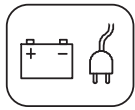

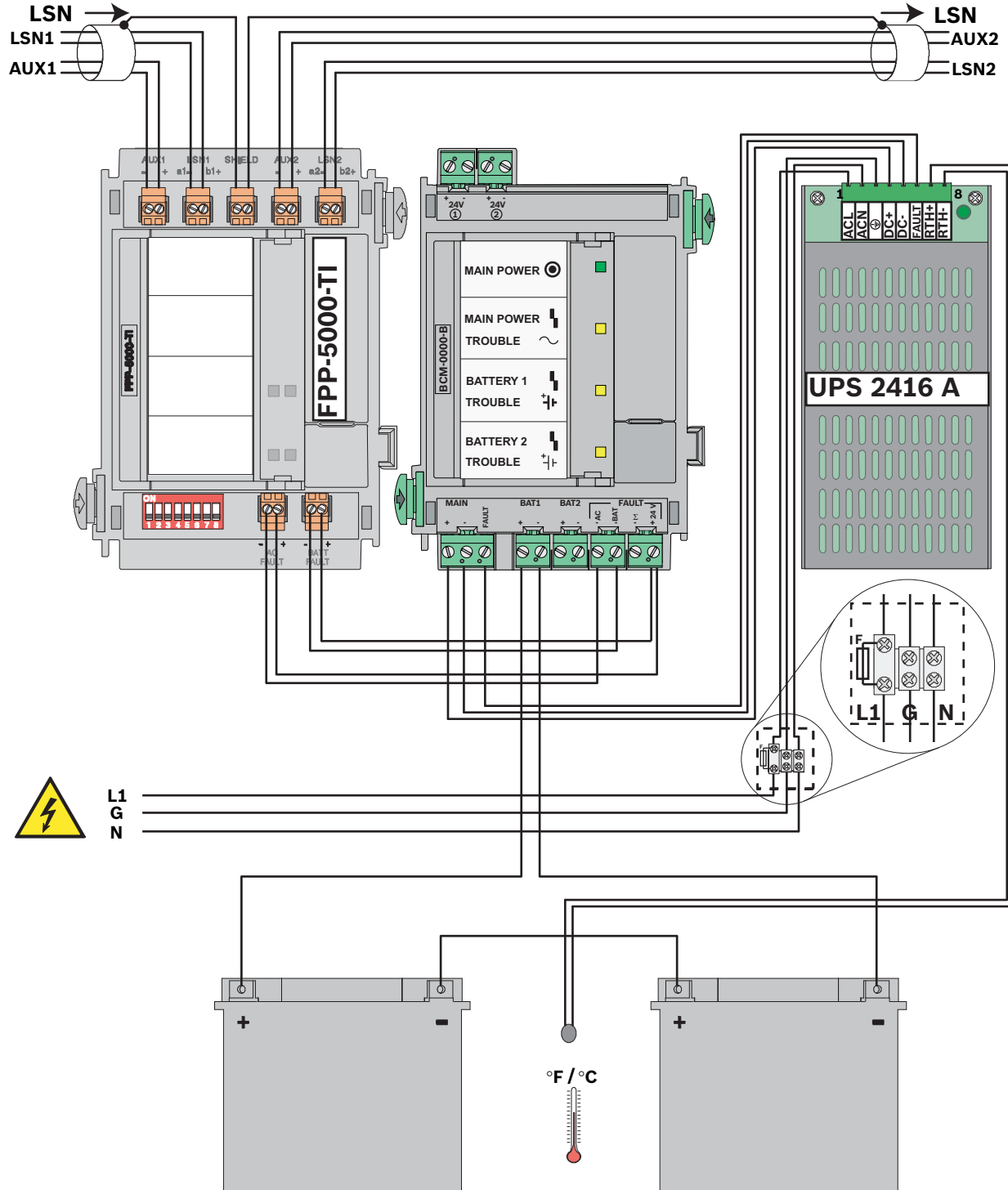

BCM 0000 B



	FPA-5000	BZ 500 LSN UEZ 2000 LSN UGM 2020
0 (LSN improved)	✓	-
1 - 254 (LSN improved)	✓	-
255 CL = LSN classic	✓	✓

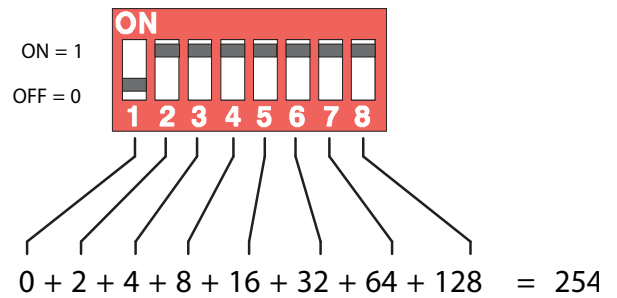
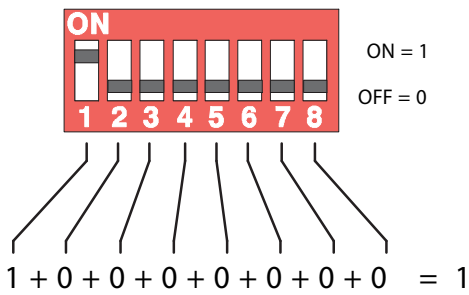
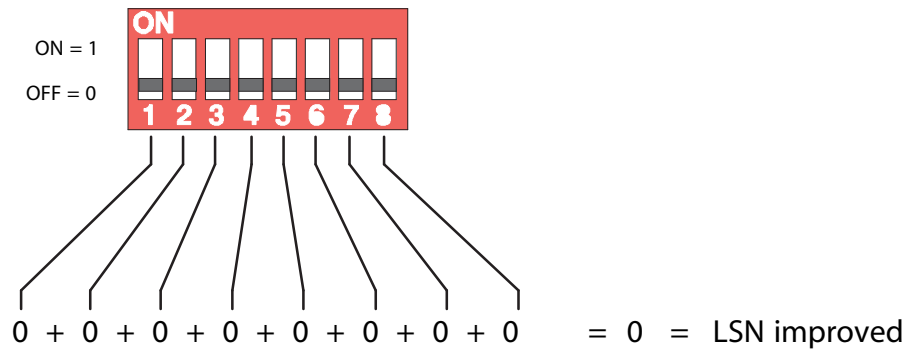
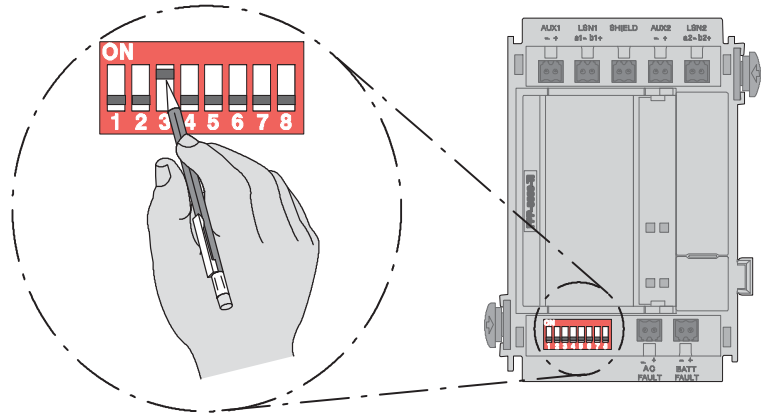

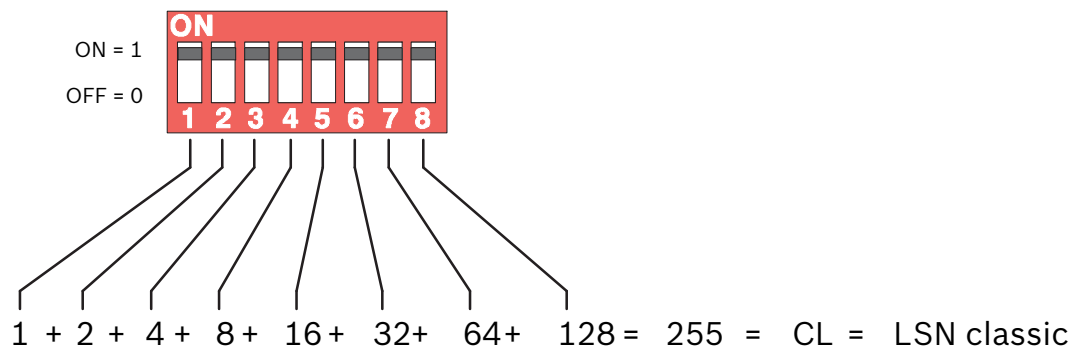

1 - 254 = LSN

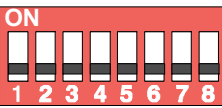

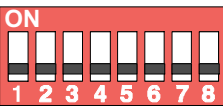

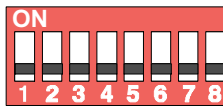
								
	1	2	3	4	5	6	7	8
A	1	2	3	4	5	6	7	8
CL=255	1	1	1	1	1	1	1	1
1	1	0	0	0	0	0	0	0
2	0	1	0	0	0	0	0	0
3	1	1	0	0	0	0	0	0
4	0	0	1	0	0	0	0	0
5	1	0	1	0	0	0	0	0
6	0	1	1	0	0	0	0	0
7	1	1	1	0	0	0	0	0
8	0	0	0	1	0	0	0	0
9	1	0	0	1	0	0	0	0
10	0	1	0	1	0	0	0	0
11	1	1	0	1	0	0	0	0
12	0	0	1	1	0	0	0	0
13	1	0	1	1	0	0	0	0
14	0	1	1	1	0	0	0	0
15	1	1	1	1	0	0	0	0
16	0	0	0	0	1	0	0	0
17	1	0	0	0	1	0	0	0
18	0	1	0	0	1	0	0	0
19	1	1	0	0	1	0	0	0
20	0	0	1	0	1	0	0	0
21	1	0	1	0	1	0	0	0
22	0	1	1	0	1	0	0	0
23	1	1	1	0	1	0	0	0
24	0	0	0	1	1	0	0	0
25	1	0	0	1	1	0	0	0
26	0	1	0	1	1	0	0	0
27	1	1	0	1	1	0	0	0
28	0	0	1	1	1	0	0	0
29	1	0	1	1	1	0	0	0
30	0	1	1	1	1	0	0	0
31	1	1	1	1	1	0	0	0
32	0	0	0	0	0	1	0	0
33	1	0	0	0	0	1	0	0
34	0	1	0	0	0	1	0	0
35	1	1	0	0	0	1	0	0
36	0	0	1	0	0	1	0	0
37	1	0	1	0	0	1	0	0
38	0	1	1	0	0	1	0	0
39	1	1	1	0	0	1	0	0
40	0	0	0	1	0	1	0	0
41	1	0	0	1	0	1	0	0

								
	1	2	3	4	5	6	7	8
A	1	2	3	4	5	6	7	8
42	0	1	0	1	0	1	0	0
43	1	1	0	1	0	1	0	0
44	0	0	1	1	0	1	0	0
45	1	0	1	1	0	1	0	0
46	0	1	1	1	0	1	0	0
47	1	1	1	1	0	1	0	0
48	0	0	0	0	1	1	0	0
49	1	0	0	0	1	1	0	0
50	0	1	0	0	1	1	0	0
51	1	1	0	0	1	1	0	0
52	0	0	1	0	1	1	0	0
53	1	0	1	0	1	1	0	0
54	0	1	1	0	1	1	0	0
55	1	1	1	0	1	1	0	0
56	0	0	0	1	1	1	0	0
57	1	0	0	1	1	1	0	0
58	0	1	0	1	1	1	0	0
59	1	1	0	1	1	1	0	0
60	0	0	1	1	1	1	0	0
61	1	0	1	1	1	1	0	0
62	0	1	1	1	1	1	0	0
63	1	1	1	1	1	1	0	0
64	0	0	0	0	0	0	1	0
65	1	0	0	0	0	0	1	0
66	0	1	0	0	0	0	1	0
67	1	1	0	0	0	0	1	0
68	0	0	1	0	0	0	1	0
69	1	0	1	0	0	0	1	0
70	0	1	1	0	0	0	1	0
71	1	1	1	0	0	0	1	0
72	0	0	0	1	0	0	1	0
73	1	0	0	1	0	0	1	0
74	0	1	0	1	0	0	1	0
75	1	1	0	1	0	0	1	0
76	0	0	1	1	0	0	1	0
77	1	0	1	1	0	0	1	0
78	0	1	1	1	0	0	1	0
79	1	1	1	1	0	0	1	0
80	0	0	0	0	1	0	1	0
81	1	0	0	0	1	0	1	0
82	0	1	0	0	1	0	1	0
83	1	1	0	0	1	0	1	0

								
	1	2	3	4	5	6	7	8
A	1	2	3	4	5	6	7	8
84	0	0	1	0	1	0	1	0
85	1	0	1	0	1	0	1	0
86	0	1	1	0	1	0	1	0
87	1	1	1	0	1	0	1	0
88	0	0	0	1	1	0	1	0
89	1	0	0	1	1	0	1	0
90	0	1	0	1	1	0	1	0
91	1	1	0	1	1	0	1	0
92	0	0	1	1	1	0	1	0
93	1	0	1	1	1	0	1	0
94	0	1	1	1	1	0	1	0
95	1	1	1	1	1	0	1	0
96	0	0	0	0	0	1	1	0
97	1	0	0	0	0	1	1	0
98	0	1	0	0	0	1	1	0
99	1	1	0	0	0	1	1	0
100	0	0	1	0	0	1	1	0
101	1	0	1	0	0	1	1	0
102	0	1	1	0	0	1	1	0
103	1	1	1	0	0	1	1	0
104	0	0	0	1	0	1	1	0
105	1	0	0	1	0	1	1	0
106	0	1	0	1	0	1	1	0
107	1	1	0	1	0	1	1	0
108	0	0	1	1	0	1	1	0
109	1	0	1	1	0	1	1	0
110	0	1	1	1	0	1	1	0
111	1	1	1	1	0	1	1	0
112	0	0	0	0	1	1	1	0
113	1	0	0	0	1	1	1	0
114	0	1	0	0	1	1	1	0
115	1	1	0	0	1	1	1	0
116	0	0	1	0	1	1	1	0
117	1	0	1	0	1	1	1	0
118	0	1	1	0	1	1	1	0
119	1	1	1	0	1	1	1	0
120	0	0	0	1	1	1	1	0
121	1	0	0	1	1	1	1	0
122	0	1	0	1	1	1	1	0
123	1	1	0	1	1	1	1	0
124	0	0	1	1	1	1	1	0
125	1	0	1	1	1	1	1	0

								
	1	2	3	4	5	6	7	8
A	1	2	3	4	5	6	7	8
126	0	1	1	1	1	1	1	0
127	1	1	1	1	1	1	1	0
128	0	0	0	0	0	0	0	1
129	1	0	0	0	0	0	0	1
130	0	1	0	0	0	0	0	1
131	1	1	0	0	0	0	0	1
132	0	0	1	0	0	0	0	1
133	1	0	1	0	0	0	0	1
134	0	1	1	0	0	0	0	1
135	1	1	1	0	0	0	0	1
136	0	0	0	1	0	0	0	1
137	1	0	0	1	0	0	0	1
138	0	1	0	1	0	0	0	1
139	1	1	0	1	0	0	0	1
140	0	0	1	1	0	0	0	1
141	1	0	1	1	0	0	0	1
142	0	1	1	1	0	0	0	1
143	1	1	1	1	0	0	0	1
144	0	0	0	0	1	0	0	1
145	1	0	0	0	1	0	0	1
146	0	1	0	0	1	0	0	1
147	1	1	0	0	1	0	0	1
148	0	0	1	0	1	0	0	1
149	1	0	1	0	1	0	0	1
150	0	1	1	0	1	0	0	1
151	1	1	1	0	1	0	0	1
152	0	0	0	1	1	0	0	1
153	1	0	0	1	1	0	0	1
160	0	0	0	0	0	1	0	1
161	0	1	0	0	0	1	0	1
162	0	1	0	0	0	1	0	1
163	1	1	0	0	0	1	0	1
164	0	0	1	0	0	1	0	1
165	1	0	1	0	0	1	0	1
166	0	1	1	0	0	1	0	1
167	1	1	1	0	0	1	0	1
168	0	0	0	1	0	1	0	1
169	1	0	0	1	0	1	0	1
170	0	1	0	1	0	1	0	1
171	1	1	0	1	0	1	0	1
172	0	0	1	1	0	1	0	1
173	1	0	1	1	0	1	0	1

								
	1	2	3	4	5	6	7	8
A	1	2	3	4	5	6	7	8
174	0	1	1	1	0	1	0	1
175	1	1	1	1	0	1	0	1
176	0	0	0	0	1	1	0	1
177	1	0	0	0	1	1	0	1
178	0	1	0	0	1	1	0	1
179	1	1	0	0	1	1	0	1
180	0	0	1	0	1	1	0	1
181	1	0	1	0	1	1	0	1
182	0	1	1	0	1	1	0	1
183	1	1	1	0	1	1	0	1
184	0	0	0	1	1	1	0	1
185	1	0	0	1	1	1	0	1
186	0	1	0	1	1	1	0	1
187	1	1	0	1	1	1	0	1
188	0	0	1	1	1	1	0	1
189	1	0	1	1	1	1	0	1
190	0	1	1	1	1	1	0	1
191	1	1	1	1	1	1	0	1
192	0	0	0	0	0	0	1	1
193	1	0	0	0	0	0	1	1
194	0	1	0	0	0	0	1	1
195	1	1	0	0	0	0	1	1
196	0	0	1	0	0	0	1	1
197	1	0	1	0	0	0	1	1
198	0	1	1	0	0	0	1	1
199	1	1	1	0	0	0	1	1
200	0	0	0	1	0	0	1	1
201	1	0	0	1	0	0	1	1
202	0	1	0	1	0	0	1	1
203	1	1	0	1	0	0	1	1
204	0	0	1	1	0	0	1	1
205	1	0	1	1	0	0	1	1
206	0	1	1	1	0	0	1	1
207	1	1	1	1	0	0	1	1
208	0	0	0	0	1	0	1	1
209	1	0	0	0	1	0	1	1
210	0	1	0	0	1	0	1	1
211	1	1	0	0	1	0	1	1
212	0	0	1	0	1	0	1	1
213	1	0	1	0	1	0	1	1
214	0	1	1	0	1	0	1	1
215	1	1	1	0	1	0	1	1

								
	1	2	3	4	5	6	7	8
A	1	2	3	4	5	6	7	8
216	0	0	0	1	1	0	1	1
217	1	0	0	1	1	0	1	1
218	0	1	0	1	1	0	1	1
219	1	1	0	1	1	0	1	1
220	0	0	1	1	1	0	1	1
221	1	0	1	1	1	0	1	1
222	0	1	1	1	1	0	1	1
223	1	1	1	1	1	0	1	1
224	0	0	0	0	0	1	1	1
225	1	0	0	0	0	1	1	1
226	0	1	0	0	0	1	1	1
227	1	1	0	0	0	1	1	1
228	0	0	1	0	0	1	1	1
229	1	0	1	0	0	1	1	1
230	0	1	1	0	0	1	1	1
231	1	1	1	0	0	1	1	1
232	0	0	0	1	0	1	1	1
233	1	0	0	1	0	1	1	1
234	0	1	0	1	0	1	1	1
235	1	1	0	1	0	1	1	1
236	0	0	1	1	0	1	1	1
237	1	0	1	1	0	1	1	1
238	0	1	1	1	0	1	1	1
239	1	1	1	1	0	1	1	1
240	0	0	0	0	1	1	1	1
241	1	0	0	0	1	1	1	1
242	0	1	0	0	1	1	1	1
243	1	1	0	0	1	1	1	1
244	0	0	1	0	1	1	1	1
245	1	0	1	0	1	1	1	1
246	0	1	1	0	1	1	1	1
247	1	1	1	0	1	1	1	1
248	0	0	0	1	1	1	1	1
249	1	0	0	1	1	1	1	1
250	0	1	0	1	1	1	1	1
251	1	1	0	1	1	1	1	1
252	0	0	1	1	1	1	1	1
253	1	0	1	1	1	1	1	1
254	0	1	1	1	1	1	1	1
255=CL	1	1	1	1	1	1	1	1

Popis funkcí

Člen FPP-5000-TI představuje rozšíření Sady externího napájecího zdroje FPP-5000 24 V/6 A. Umožňuje přenos chybových zpráv signálu poruchy napájení a signálu poruchy akumulátoru do ústředny EPS prostřednictvím místní zabezpečovací sítě LSN. Tyto dvě chybové zprávy jsou zajišťovány pomocí příslušných výstupů Řídicí jednotky akumulátorů BCM-0000-B. Tato jednotka je připojena přímo k datové sběrnici LSN a je také napájena z linek datové sběrnice LSN.

Přiřazení vývodů

Č.	Označení	Připojení
1	AUX1 -	Přívod pomocného napájení (podpěrné body pro průchozí zapojení)
2	AUX1 +	
3	LSN1 a1 -	LSN příchozí
4	LSN1 b1 +	
5	SHIELD	Stíněný vodič
6	SHIELD	
7	AUX2 -	Vývod pomocného napájení (podpěrné body pro průchozí zapojení)
8	AUX2 +	
9	LSN1 a2 -	LSN odchozí
10	LSN1 b2 +	
11	AC FAULT -	Vstup poruchy napájení
12	AC FAULT +	
13	BATT FAULT -	Vstup poruchy akumulátoru
14	BATT FAULT +	

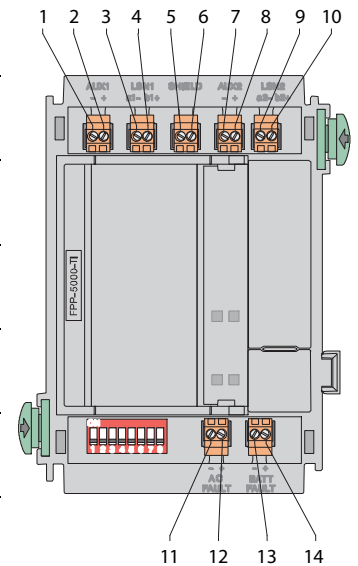

Technické specifikace

FPP-5000-TI Vazební člen pro signalizaci poruch pro sadu FPP-5000	
Vstupní napětí (min - max)	+15 V DC až +33 V DC
Maximální odběr proudu	1,15 mA při 24 V DC (ze sítě LSN)
Třída krytí podle IEC 60529	IP 20
Přípustná provozní teplota	-5 °C až 50 °C
Přípustná skladovací teplota	-20 °C až 60 °C
Relativní vlhkost	Max. 95 % nekondenzující
Nastavení adresy	Prostřednictvím osmi dvoupolohových mikropřepínačů
Materiál a barva krytu	Plast ABS, (UL94 V-0), pololesklá antracitová, RAL 7016
Rozměry (Š × V × D)	Přibližně 127 × 96 × 60 mm

Funktionsbeskrivelse

FPP-5000-TI er en udvidelse til FPP-5000 eksternt strømforsyningsenhedssæt 24 V/6 A. Den sørger for fejlmeddelelsesoverførslen af fejlsignalet fra 230 V-tilslutningen og batteriet til brandcentralen via det lokale sikkerhedsnetværk LSN. De to fejlmeddelelser fås fra de tilsvarende udgange på BCM-0000-B batteri-kontrollermodul. Modulet er direkte tilsluttet til LSN-databussen og får også tilført strøm via LSN-databuslinjen.

Terminaltildeling

Pos.	Opmærkning	Tilslutning
1	AUX1 -	Ekstra strømforsyning indgående (støttestrukturer at loope igennem)
2	AUX1 +	
3	LSN1 a1 -	LSN indgående
4	LSN1 b1 +	
5	SHIELD	Skærmet kabel
6	SHIELD	
7	AUX2 -	Ekstra strømforsyning udgående (støttestrukturer at loope igennem)
8	AUX2 +	
9	LSN1 a2 -	LSN udgående
10	LSN1 b2 +	
11	AC FAULT -	Lysnetfejl indgang
12	AC FAULT +	
13	BATT FAULT -	Batterifejl indgang
14	BATT FAULT +	

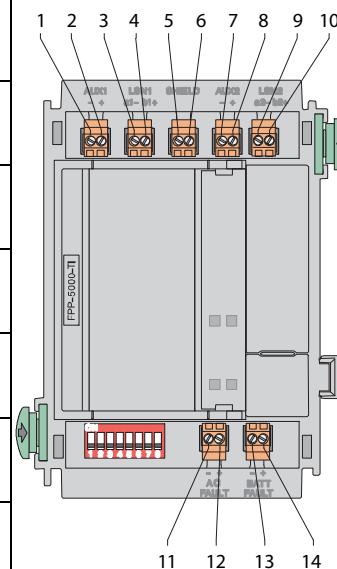

Tekniske specifikationer

FPP-5000-TI fejlinterface til FPP-5000	
Indgangsspænding (min - max)	+15 V DC . . +33 V DC
Maks. strømforbrug	1,15 mA ved 24 V DC (fra LSN)
Beskyttelseskategori ifølge IEC 60529	IP 20
Tilladte driftstemp.	-5 °C . . . 50 °C (23 °F . . . 122 °F)
Tilladte opbevaringstemp.	-20 °C . . . 60 °C (-4 °F . . . 140 °F)
Relativ fugtighed	Maks. 95 % ikke-kondenserende
Adresseindstilling	Via otte DIP-switches
Kabinetmateriale og -farve	ABS-plast, (UL94 V-0), halvglans antracit, RAL 7016
Dimensioner (B x H x L)	Ca. 127 x 96 x 60 mm (ca. 5,0 x 3,8 x 2,4")

Funktionsbeschreibung

Das FPP-5000-TI wird im FPP-5000 Bausatz externes Netzteil 24 V/6 A eingesetzt. Es dient zur Weiterleitung der Störungsanzeigen "Batteriestörung" und "Netzstörung" an die Brandmeldezentrale über das Lokale SicherheitsNetzwerk LSN. Die beiden Störungssignale werden von den entsprechenden Ausgängen am BCM-0000-B Batterieregler-Modul abgegriffen. Das FPP-5000-TI wird direkt an die Busleitung des LSN angeschaltet und über die Busleitung mit Spannung versorgt.

Klemmenbelegung

Pos.	Markierung	Anschluss
1	AUX1 -	Zusatzspannungsversorgung kommend (Stützpunkte zum Durchschleifen)
2	AUX1 +	
3	LSN1 a1 -	LSN kommend
4	LSN1 b1 +	
5	SHIELD	Schirmbeidraht
6	SHIELD	
7	AUX2 -	Zusatzspannungsversorgung gehend (Stützpunkte zum Durchschleifen)
8	AUX2 +	
9	LSN1 a2 -	LSN gehend
10	LSN1 b2 +	
11	AC FAULT -	Eingang Netzstörung
12	AC FAULT +	
13	BATT FAULT -	Eingang Batteriestörung
14	BATT FAULT +	

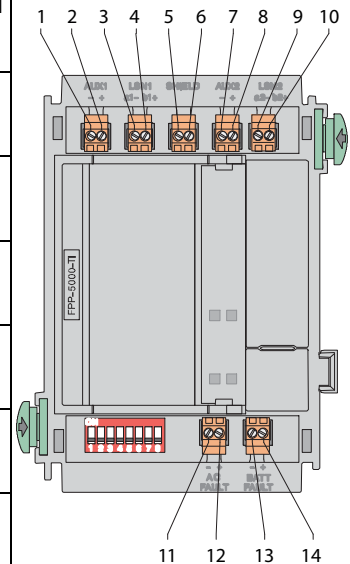

Technische Daten

FPP-5000-TI Modul zur Störungsweiterleitung für FPP-5000	
Eingangsspannung (min - max)	+15 V DC . . . +33 V DC
Maximale Stromaufnahme	1,15 mA bei 24 V DC (aus dem LSN)
Schutzklasse IEC 60529	IP 20
Zulässige Betriebstemperatur	-5 °C . . . 50 °C
Zulässige Lagertemperatur	-20 °C . . . 60 °C
Zulässige relative Feuchte	Max. 95 % nicht kondensierend
Adressierung	Über acht DIP-Schalter
Gehäusematerial und Farbe	ABS Kunststoff, (UL94 V-0), seidenmatt anthrazit, RAL 7016
Abmessungen (H x B x T)	ca. 127 x 96 x 60 mm

Περιγραφή λειτουργίας

Το FPP-5000-TI είναι μια επέκταση για το κιτ μονάδας εξωτερικού τροφοδοτικού FPP-5000 24 V/6 A. Παρέχει τη μετάδοση μηνύματος προβλήματος του σήματος σφάλματος κύριας ισχύος και του σήματος σφάλματος μπαταρίας στον πίνακα πυροπροστασίας μέσω του τοπικού δικτύου ασφαλείας (Local SecurityNetwork, LSN). Τα δύο μηνύματα σφάλματος παρέχονται από τις αντίστοιχες εξόδους στο δομοστοιχείο ελεγκτή μπαταρίας BCM-0000-B. Το δομοστοιχείο συνδέεται απευθείας στο διαύλο δεδομένων LSN και επίσης τροφοδοτείται με ρεύμα μέσω της γραμμής διαύλου δεδομένων LSN.

Εκχώρηση τερματικών

Θέση	Επισήμανση	Σύνδεση
1	AUX1 -	Βοηθητικό τροφοδοτικό εισερχόμενο (σημεία στήριξης για βρόχο διέλευσης)
2	AUX1 +	
3	LSN1 a1 -	LSN εισερχόμενο
4	LSN1 b1 +	
5	SHIELD	Καλώδιο θωράκισης
6	SHIELD	
7	AUX2 -	Βοηθητικό τροφοδοτικό εξερχόμενο (σημεία στήριξης για βρόχο διέλευσης)
8	AUX2 +	
9	LSN1 a2 -	LSN εξερχόμενο
10	LSN1 b2 +	
11	AC FAULT -	Είσοδος σφάλματος κύριας ισχύος
12	AC FAULT +	
13	BATT FAULT -	Είσοδος σφάλματος μπαταρίας
14	BATT FAULT +	

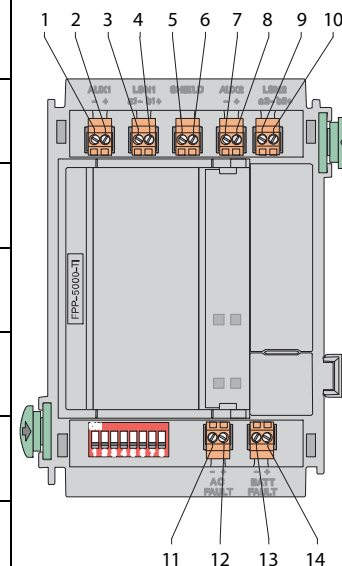

Τεχνικές προδιαγραφές

FPP-5000-TI Διασύνδεση μετάδοσης προβλήματος για το FPP-5000	
Τάση εισόδου (ελάχ. - μέγ.)	+15 V DC .. +33 V DC
Μέγιστη κατανάλωση ρεύματος	1,15 mA στα 24 V DC (από LSN)
Τύπος προστασίας σύμφωνα με IEC 60529	IP 20
Επιτρεπτή θερμοκρασία λειτουργίας	-5 °C ... 50 °C (23 °F ... 122 °F)
Επιτρεπτή θερμοκρασία αποθήκευσης	-20 °C ... 60 °C (-4 °F ... 140 °F)
Σχετική υγρασία	Μέγ. 95 % χωρίς συμπύκνωση υδρατμών
Ρύθμιση διεύθυνσης	Μέσω οκτώ μικροδιακοπών (DIP)
Υλικά επένδυσης και χρώματα	Πλαστικό ABS, (UL94 V-0), ημι-γυαλιστερό ανθρακί, RAL 7016
Διαστάσεις (Π x Υ x Μ)	Περίπου 127 x 96 x 60 mm (περίπου 5,0 x 3,8 x 2,4 ίντσες)

Functional Description

The FPP-5000-TI is an extension for the FPP-5000 External Power Supply Unit Kit 24 V/6 A. It provides the fault message transfer of the mains fault signal and the battery fault signal to the fire panel via the Local SecurityNetwork LSN. The two fault messages are provided by the corresponding outputs at the BCM-0000-B Battery Controller Module. The FPP-5000-TI is directly connected to the LSN data bus and is also power supplied via the LSN data bus line.

Terminal Assignment

Pos.	Labelling	Connection
1	AUX1 -	Auxiliary power supply incoming (support points to loop through)
2	AUX1 +	
3	LSN1 a1 -	LSN incoming
4	LSN1 b1 +	
5	SHIELD	Shield wire
6	SHIELD	
7	AUX2 -	Auxiliary power supply outgoing (support points to loop through)
8	AUX2 +	
9	LSN1 a2 -	LSN outgoing
10	LSN1 b2 +	
11	AC FAULT -	Mains fault input
12	AC FAULT +	
13	BATT FAULT -	Battery fault input
14	BATT FAULT +	

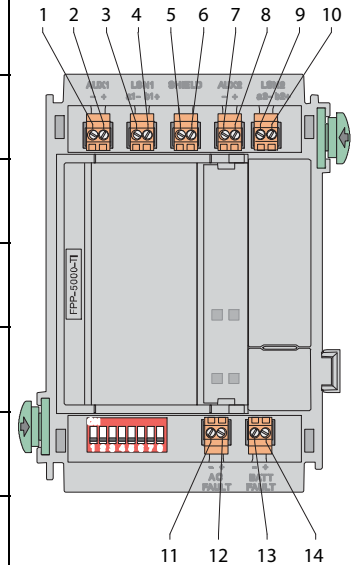

Technical Specifications

FPP-5000-TI Trouble Interface for FPP-5000	
Input voltage (min - max)	+15 V DC . . . +33 V DC
Maximum current consumption	1.15 mA at 24 V DC (from LSN)
Protection type as per IEC 60529	IP 20
Permissible operating temp.	-5 °C . . . 50 °C (23 °F . . . 122 °F)
Permissible storage temp.	-20 °C . . . 60 °C (-4 °F . . . 140 °F)
Relative humidity	Max. 95 % non-condensing
Address setting	Via eight DIP switches
Housing material and color	ABS plastic, (UL94 V-0), semi-gloss anthracite, RAL 7016
Dimensions (W x H x L)	Approx. 127 x 96 x 60 mm (approx. 5.0 x 3.8 x 2.4 inches)

Descripción funcional

El FPP-5000-TI es una extensión para la Fuente de Alimentación Externa de 24 V/6 A FPP-5000. Permite transmitir el mensaje de avería de alimentación y de avería de batería a la central de incendios directamente a través del lazo LSN. Las correspondientes salidas suministran los dos mensajes de avería en el Módulo Controlador de Batería BCM-0000-B. El módulo se encuentra conectado directamente con el bus de datos LSN y se alimenta automáticamente a través de este.

Asignación de terminales

Pos.	Etiquetado	Conexión
1	AUX1 -	Alimentación auxiliar entrante (permite la conexión en lazo)
2	AUX1 +	
3	LSN1 a1 -	LSN entrante
4	LSN1 b1 +	
5	SHIELD	Cable apantallado
6	SHIELD	
7	AUX2 -	Alimentación auxiliar saliente (permite la conexión en lazo)
8	AUX2 +	
9	LSN1 a2 -	LSN saliente
10	LSN1 b2 +	
11	AC FAULT -	Fallo de entrada de alimentación
12	AC FAULT +	
13	BATT FAULT -	Fallo de entrada de batería
14	BATT FAULT +	

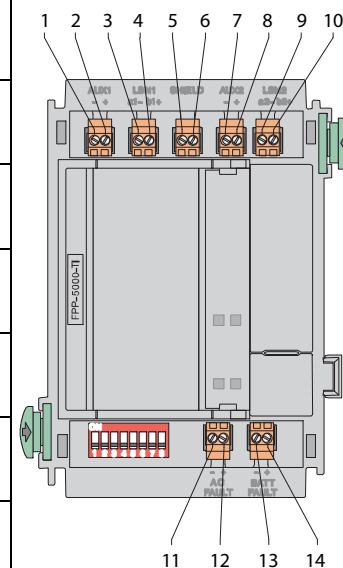

Especificaciones técnicas

Módulo de Avería FPP-5000-TI para FPP-5000	
Tensión de entrada (min. - máx.)	+15 V CC. . . +33 V CC
Consumo máximo de corriente	1,15 mA a 24 V CC (desde LSN)
Tipo de protección según IEC 60529	IP 20
Temperatura de funcionamiento permitida	-5 °C . . . 50 °C (23 °F . . . 122 °F)
Temperatura de almacenamiento permitida	-20 °C . . . 60 °C (-4 °F . . . 140 °F)
Humedad relativa	Máx. 95% sin condensación
Ajuste de direcciones	Mediante ocho conmutadores DIP
Material y color de la carcasa	Plástico ABS, (UL94 V-0), antracita semibrillante, RAL 7016
Dimensiones (An. x Al. x Long.)	Aprox. 127 x 96 x 60 mm (aprox. 5,0 x 3,8 x 2,4 pulgadas)

Description fonctionnelle

Le module FPP-5000-TI est une extension du kit bloc d'alimentation externe FPP-5000 24 V/6 A. Il assure le transfert des messages de défaillance de l'alimentation secteur et de l'alimentation par batterie à la centrale incendie via le réseau local de sécurité (LSN). Les deux messages de défaillance sont générés par les sorties correspondantes du module de commande de batterie BCM-0000-B. Le module est connecté directement au bus de données LSN et alimenté par son alimentation.

Affectation des bornes

N°	Étiquetage	Connexion
1	AUX1 -	Alimentation auxiliaire entrante (prise en charge des points et mise en boucle)
2	AUX1 +	
3	LSN1 a1 -	LSN entrant
4	LSN1 b1 +	
5	SHIELD	Câble blindé
6	SHIELD	
7	AUX2 -	Alimentation auxiliaire sortante (prise en charge des points et mise en boucle)
8	AUX2 +	
9	LSN1 a2 -	LSN sortant
10	LSN1 b2 +	
11	AC FAULT -	Entrée défaillance secteur
12	AC FAULT +	
13	BATT FAULT -	Entrée défaillance batterie
14	BATT FAULT +	

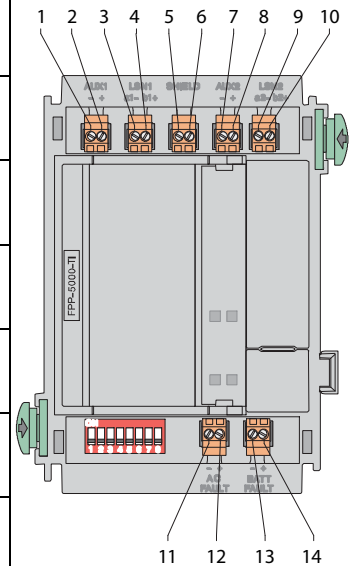

Spécifications techniques

Interface de défaillance FPP-5000-TI pour FPP-5000	
Tension d'entrée (min. - max.)	+15 V c.c. . . +33 V c.c.
Consommation de courant maximale	1,15 mA à 24 V c.c. (depuis LSN)
Type de protection suivant IEC 60529	IP 20
Température de fonctionnement admissible	-5 °C. . . 50 °C
Température de stockage admissible	-20 °C . . 60 °C
Humidité relative	95 % max. sans condensation
Paramétrage de l'adressage	Par huit commutateurs DIP
Matière et couleur du boîtier	Plastique ABS (UL94 V-0), anthracite semi-brillant, RAL 7016
Dimensions (l x H x L)	env. 127 x 96 x 60 mm

Opis funkcija

FPP-5000-TI je dodatak FPP-5000 priboru vanjske jedinice napajanja 24 V/6 A. Omogućuje prijenos poruka o pogrešci tj. signala o smetnjama u mrežnom napajanju i signala o kvaru baterije na upravljačkoj ploči vatrodojavnog sustava putem lokalne sigurnosne mreže tj. LSN-a. Ove dvije poruke o pogreškama šalju odgovarajući izlazi na BCM-0000-B modulu kontrolera baterije. Modul je izravno spojen na LSN sabirnicu podataka i napaja se pomoću LSN voda sabirnice podataka.

Dodjela priključaka

Pol.	Oznaka	Priključak
1	AUX1 -	Pomoćni ulazni izvor napajanja (napaja elemente kroz petlju)
2	AUX1 +	
3	LSN1 a1 -	LSN ulazni
4	LSN1 b1 +	
5	SHIELD	Zaštita kabela
6	SHIELD	
7	AUX2 -	Pomoćni izlazni izvor napajanja (napaja elemente kroz petlju)
8	AUX2 +	
9	LSN1 a2 -	LSN izlazni
10	LSN1 b2 +	
11	AC FAULT -	Ulaz smetnje u mrežnom napajanju
12	AC FAULT +	
13	BATT FAULT -	Ulaz kvara baterije
14	BATT FAULT +	

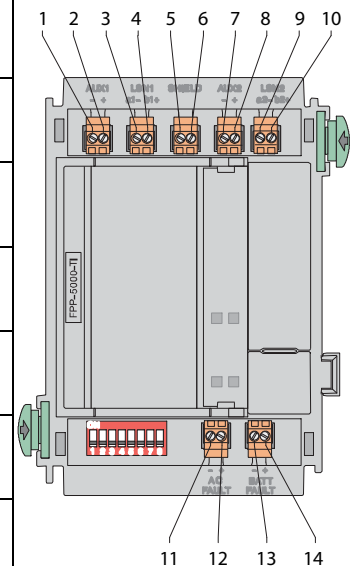

Tehničke specifikacije

FPP-5000-TI sučelje smetnji za FPP-5000	
Ulazni napon (min - maks.)	+15 V DC . . . +33 V DC
Maksimalna potrošnja struje	1,15 mA pri 24 V DC (iz LSN-a)
Vrsta zaštite prema IEC 60529	IP 20
Dopuštena radna temperatura	-5 °C . . . 50 °C (23 °F . . . 122 °F)
Dopuštena temperatura za skladištenje	-20 °C . . . 60 °C (4 °F . . . 140 °F)
Relativna vlažnost	Maksimalno 95 %, bez kondenzacije
Podешavanje adrese	pomoću osam (8) DIP sklopki
Materijal i boja kućišta	ABS plastika, (UL94 V-0), polusjajni antracit, RAL 7016
Dimenzije (Š x V x D)	približno 127 x 96 x 60 mm (približno 5,0 x 3,8 x 2,4 inča)

A működés ismertetése

Az FPP-5000-TI eszköz az FPP-5000 jelű (24 V/6 A) külső tápegységkészlet bővítménye. Hibaüzeneteket továbbít a hálózathiba-jelekről és az akkumulátorhiba-jelekről a tűzjelző központba, a Local SecurityNetwork (LSN) hálózaton keresztül. A két hibaüzenet a BCM-0000-B akkumulátor-vezérlő modul megfelelő kimeneteiről érkezik. A modul közvetlenül csatlakozik az LSN-adatbuszra, és tápellátását is az LSN-adatbusz vezetékéről nyeri.

Csatlakozókiosztás

Elhelyezés	Jelölése	Csatlakozások
1	AUX1 -	Bejövő kiegészítő tápellátás (csatlakozási pontok hurkolt tápellátáshoz)
2	AUX1 +	
3	LSN1 a1 -	Bejövő LSN
4	LSN1 b1 +	
5	SHIELD	Árnyékolt vezeték
6	SHIELD	
7	AUX2 -	Kimenő kiegészítő tápellátás (csatlakozási pontok hurkolt tápellátáshoz)
8	AUX2 +	
9	LSN1 a2 -	Kimenő LSN
10	LSN1 b2 +	
11	AC FAULT -	Hálózathiba bemenet
12	AC FAULT +	
13	BATT FAULT -	Akkumulátorhiba bemenet
14	BATT FAULT +	

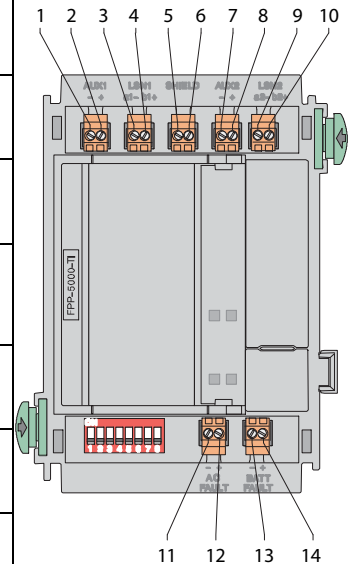

Műszaki specifikációk

FPP-5000-TI hibacsatló az FPP-5000 eszközhöz	
Bemenő feszültség (min - max)	+15 V DC . . . +33 V DC
Maximális áramfelvétel	1,15 mA 24 V DC-nél (LSN-ről)
Védelmi besorolás az IEC 60529 szabvány szerint	IP 20
Megengedett működési hőmérséklet	-5 °C . . . 50 °C .
Megengedett tárolási hőmérséklet	-20 °C . . . 60 °C .
Relatív páratartalom	Max. 95%, lecsapódás nélkül
Cím beállítása	Nyolc DIP-kapcsolón keresztül
Burkolat anyaga és színe	ABS-műanyag, (UL94 V-0), félfényes antracit, RAL 7016
Méretek (szé x ma x mé)	Kb. 127 x 96 x 60 mm

Descrizione delle funzioni

FPP-5000-TI è un'estensione per Kit unità di alimentazione esterna FPP-5000 24 V/6 A. Fornisce il trasferimento dei messaggi di errore relativi ai segnali di guasto alimentazione di rete e di guasto batteria alla centrale di rivelazione incendio tramite la rete locale di sicurezza (LSN, Local Security Network). I due messaggi di errore vengono forniti nelle uscite corrispondenti del modulo di controllo batteria BCM-0000-B. Il modulo è direttamente collegato al bus di dati LSN ed è alimentato tramite la relativa linea.

Assegnazione dei terminali

Pos.	Etichette	Collegamento
1	AUX1 -	Alimentazione ausiliaria in entrata (supporta punti per il loop-through)
2	AUX1 +	
3	LSN1 a1 -	LSN in entrata
4	LSN1 b1 +	
5	SHIELD	Cavo schermato
6	SHIELD	
7	AUX2 -	Alimentazione ausiliaria in uscita (supporta punti per il loop-through)
8	AUX2 +	
9	LSN1 a2 -	LSN in uscita
10	LSN1 b2 +	
11	AC FAULT -	Ingresso guasto alimentazione di rete
12	AC FAULT +	
13	BATT FAULT -	Ingresso guasto batteria
14	BATT FAULT +	

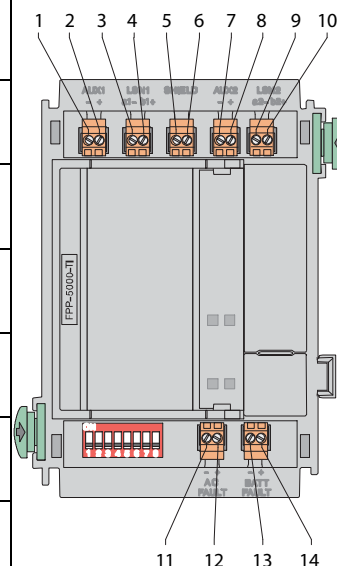

Specifiche tecniche

FPP-5000-TI Interfaccia guasti per l'unità FPP-5000	
Tensione di ingresso (min - max)	+15 VDC . . . +33 VDC
Consumo massimo di corrente	1,15 mA a 24 VDC (da LSN)
Tipo di protezione conforme a IEC 60529	IP 20
Temperatura di esercizio consentita	-5 °C . 50 °C .
Temperatura di stoccaggio consentita	-20 °C . 60 °C .
Umidità relativa	Max 95% senza condensa
Impostazione indirizzamento	Tramite otto interruttori DIP
Materiale alloggiamento e colore	Plastica ABS, (UL94 V-0), antracite semilucida, RAL 7016
Dimensioni (Largh. x Alt. x Lungh.)	Circa 127 x 96 x 60 mm

Functionele omschrijving

De FPP-5000-TI is een uitbreiding voor de FPP-5000 Externe Voedingskit 24 V/6 A. Deze interfacemodule zorgt voor de overdracht van de storingsmelding van het netspanningsstoringssignaal en het accustoringsignaal naar de brandmeldcentrale via het LSN (Local Security Network). De twee storingsmeldingen worden geleverd via de overeenkomstige uitgangen op de BCM-0000-B Accucontrollermodule. De module wordt direct aangesloten op de LSN-databus en wordt tevens via de LSN-databuslijn voorzien van spanning.

Klembezetting

Pos.	Label	Aansluiting
1	AUX1 -	Voeding voor randapparatuur inkomend (klemmen voor doorlussen)
2	AUX1 +	
3	LSN1 a1 -	LSN inkomend
4	LSN1 b1 +	
5	SHIELD	Afgeschermde kabel
6	SHIELD	
7	AUX2 -	Voeding voor randapparatuur uitgaand (klemmen voor doorlussen)
8	AUX2 +	
9	LSN1 a2 -	LSN uitgaand
10	LSN1 b2 +	
11	AC FAULT -	Ingang netspanningsstoring
12	AC FAULT +	
13	BATT FAULT -	Ingang accustoring
14	BATT FAULT +	

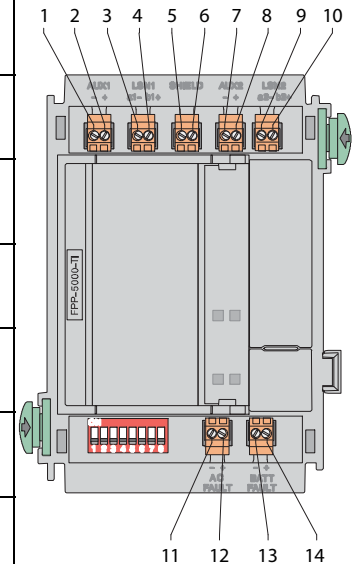

Technische specificaties

FPP-5000-TI Storingsinterface voor FPP-5000	
Ingangsspanning (min - max)	+15 VDC . . . +33 VDC
Maximaal stroomverbruik	1,15 mA bij 24 VDC (vanuit LSN)
Beschermingsklasse conform IEC 60529	IP 20
Toegestane bedrijfstemp.	-5 °C . . . 50 °C .
Toegestane opslagtemp.	-20 °C . . . 60 °C .
Relatieve vochtigheid	Max. 95%, niet-condenserend
Adresinstelling	Via acht DIP-schakelaars
Materiaal en kleur van de behuizing	ABS-kunststof, (UL94 V-0), halfglans antraciet, RAL 7016
Afmetingen (B x H x L)	Ca. 127 x 96 x 60 mm

Opis działania

Moduł FPP-5000-TI jest rozszerzeniem zestawu zewnętrznego zasilacza sieciowego 24 V/6 A FPP-5000. Umożliwia on przekazywanie za pomocą lokalnej sieci bezpieczeństwa (LSN) do centrali sygnalizacji pożaru komunikatów o usterkach sieci zasilania i usterkach akumulatora. Przez dwa odpowiednio wyjścia modułu kontrolera akumulatorów BCM-0000-B przesyłane są dwa komunikaty o usterkach. Moduł podłączony jest bezpośrednio do magistrali danych LSN i jest zasilany również przez linie magistrali danych.

Przypisanie zacisków

Poz.	Oznaczenie	Połączenie
1	AUX1 -	Połączenie wejściowe dodatkowego zasilacza (punkty mocowań do połączeń przelotowych)
2	AUX1 +	
3	LSN1 a1 -	Połączenie wejściowe LSN
4	LSN1 b1 +	
5	SHIELD	Żyła ekranująca
6	SHIELD	
7	AUX2 -	Połączenie wyjściowe dodatkowego zasilacza (punkty mocowań do połączeń przelotowych)
8	AUX2 +	
9	LSN1 a2 -	Połączenie wyjściowe LSN
10	LSN1 b2 +	
11	AC FAULT -	Wejście sygnału usterki zasilania sieciowego
12	AC FAULT +	
13	BATT FAULT -	Wejście sygnału usterki akumulatora
14	BATT FAULT +	

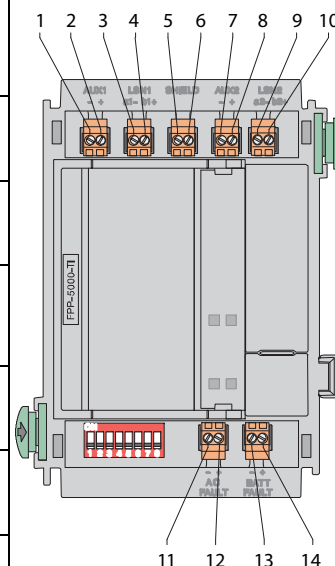

Dane techniczne

Interfejs usterek FPP-5000-TI do urządzenia FPP-5000	
Napięcie wejściowe (min. - maks.)	+15 VDC . . . +33 VDC
Maks. pobór prądu	1,15 mA przy 24 VDC (z LSN)
Klasa ochrony zgodnie z IEC 60529	IP 20
Dopuszczalna temperatura pracy	-5 °C . . . 50 °C
Dopuszczalna temperatura przechowywania	-20 °C . . 60 °C
Wilgotność względna	Maks. 95%, bez kondensacji
Ustawienia adresów	Za pośrednictwem ośmiu mikroprzełączników
Materiał obudowy i kolor	tworzywo ABS, (UL94 V-0), półpołysk, antracyt, RAL 7016
Wymiary (szer. x wys. x dł.)	Ok. 127 x 96 x 60 mm

Descrição funcional

O FPP-5000-TI é uma extensão para o Kit de Fonte de Alimentação Externa FPP-5000 de 24 V/6 A. Faz a transferência da mensagem de informação de falha do sinal de falha rede e do sinal de falha da bateria para o painel de incêndio, através da rede de segurança local LSN. As duas mensagens de falha são fornecidas pelas saídas correspondentes no Módulo de Controlador da Bateria BCM-0000-B. O módulo está directamente ligado ao bus de dados da linha LSN. A alimentação também é proveniente da linha de dados LSN.

Atribuição de terminais

Pos.	Legendagem	Ligação
1	AUX1 -	Entrada de fonte de alimentação auxiliar (pontos de apoio para "loop through")
2	AUX1 +	
3	LSN1 a1 -	LSN de entrada
4	LSN1 b1 +	
5	SHIELD	Cabo blindado
6	SHIELD	
7	AUX2 -	Saída de fonte de alimentação auxiliar (pontos de apoio para "loop through")
8	AUX2 +	
9	LSN1 a2 -	LSN de saída
10	LSN1 b2 +	
11	AC FAULT -	Entrada de falha de rede
12	AC FAULT +	
13	BATT FAULT -	Entrada de falha da bateria
14	BATT FAULT +	

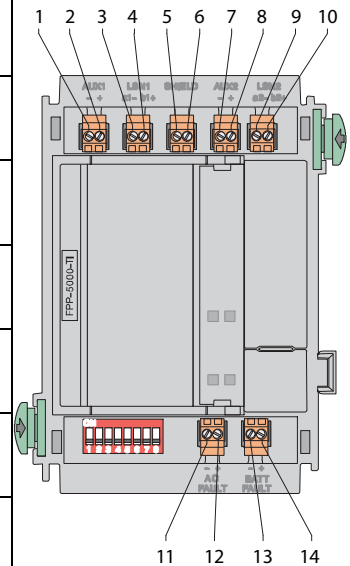

Dados técnicos

FPP-5000-TI Interface de Falhas para FPP-5000	
Tensão de entrada (mín. - máx.)	+15 Vdc . . . +33 Vdc
Consumo de corrente máx.	1,15 mA a 24 Vdc (da LSN)
Tipo de protecção em conformidade com a norma CEI 60529	IP 20
Temp. de serviço permitida	-5 °C . . . 50 °C (23 °F . . . 122 °F)
Temp. de armazenamento permitida	-20 °C . . . 60 °C (-4 °F . . . 140 °F)
Humidade relativa	Máx. 95 %, sem condensação
Definição de endereço	Através de oito interruptores DIP
Material e cor da caixa	ABS plástico, (UL94 V-0), antracite semibrilhante, RAL 7016
Dimensões (L x A x C)	Aprox. 127 x 96 x 60 mm (aprox. 5,0 x 3,8 x 2,4 pol.)

Descrierea funcțională

FPP-5000-TI este o extensie pentru kitul unitate de alimentare externă FPP-5000 24 V/6 A. Acesta furnizează transferul mesajului de defecțiune al semnalului de defecțiune rețea și semnalul de defecțiune baterie la panoul detecție incendiu prin Rețeaua de securitate locală (LSN). Cele două mesaje de defecțiune sunt furnizate de ieșirile corespunzătoare la Modulul controler baterie BCM-0000-B. Modulul este conectat direct la magistrala de date LSN și este de asemenea alimentat electric prin linia magistralei de date LSN.

Alocare borne

Nr.	Etichetare	Conexiune
1	AUX1 -	Sursă de alimentare auxiliară de intrare (acceptă puncte de ciclare)
2	AUX1 +	
3	LSN1 a1 -	LSN de intrare
4	LSN1 b1 +	
5	SHIELD	Cablul ecranat
6	SHIELD	
7	AUX2 -	Sursă de alimentare auxiliară de ieșire (acceptă puncte de ciclare)
8	AUX2 +	
9	LSN1 a2 -	LSN de ieșire
10	LSN1 b2 +	
11	AC FAULT -	Înterupere alimentare de la rețeaua de intrare
12	AC FAULT +	
13	BATT FAULT -	Înterupere alimentare de la baterie de intrare
14	BATT FAULT +	

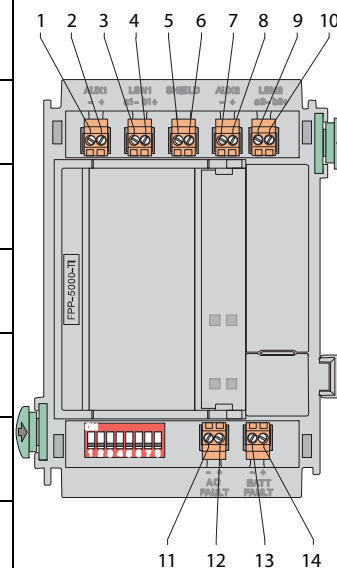

Specificații tehnice

Interfață problemă FPP-5000-TI pentru FPP-5000	
Tensiune de intrare (min - max)	+15 V CC . . . +33 V CC
Consum maxim de energie	1,15 mA la 24 V CC (de la LSN)
Tip de protecție cf. IEC 60529	IP 20
Temp. de funcționare permisă	-5 °C . . . 50 °C (23 °F . . . 122 °F)
Temp. de depozitare permisă	-20 °C . . . 60 °C (-4 °F . . . 140 °F)
Umiditate relativă	Max. 95 % fără condens
Setarea adresei	Prin opt comutatoare DIP
Material și culoare carcasă	Plastic ABS, (UL94 V-0), antracit semi-lucios, RAL 7016
Dimensiuni (l x î x L)	Aprox. 127 x 96 x 60 mm (aprox. 5,0 x 3,8 x 2,4 țoli)

Принцип работы

Модуль FPP-5000-TI представляет собой расширение для комплекта внешнего источника питания FPP-5000 24 В/6 А.

Он обеспечивает передачу сигнала о неисправности питания или аккумулятора на пожарную панель через локальную сеть безопасности LSN. Два сообщения о неисправностях обеспечиваются соответствующими выходами модуля контроллера батарей BCM-0000-B. Модуль подключен напрямую к адресному шлейфу LSN, непосредственно от которого и получает электропитание.

Назначение контактов

№	Обозначение	Подключение
1	AUX1 -	Вход источника дополнительного питания (поддерживает точки на проходное соединение)
2	AUX1 +	
3	LSN1 a1 -	LSN входящая
4	LSN1 b1 +	
5	SHIELD	Экран
6	SHIELD	
7	AUX2 -	Выход источника дополнительного питания (поддерживает точки на проходное соединение)
8	AUX2 +	
9	LSN1 a2 -	LSN исходящая
10	LSN1 b2 +	
11	AC FAULT -	Вход неисправности питания
12	AC FAULT +	
13	BATT FAULT -	Вход неисправности аккумулятора
14	BATT FAULT +	

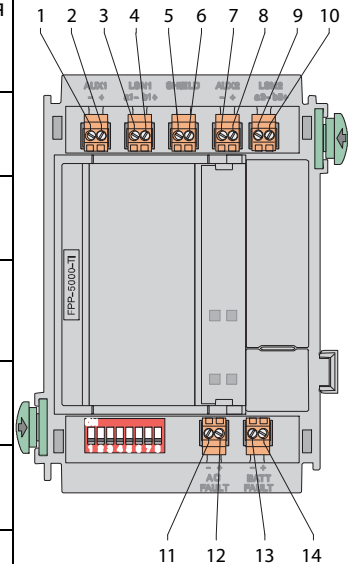

Технические характеристики

FPP-5000-TI Интерфейсный модуль контроля ИП типа FPP-5000	
Входное напряжение (мин - макс)	от +15 В до +33 В постоянного тока
Макс. потребление тока	1,15 мА при 24 В пост. тока (от LSN)
Класс защиты по IEC 60529	IP 20
Допустимая рабочая температура	от -5 °С до 50 °С
Допустимая температура хранения	от -20 °С до 60 °С
Относительная влажность	Макс. 95%, без конденсации
Настройка адреса	При помощи восьми DIP-переключателей
Материал и цвет корпуса	Пластик ABS, (UL94 V-0), полуматовый антрацит, RAL 7016
Размеры (Ш x В x Д)	Прибл. 127 x 96 x 60 мм

Funkcionalni opis

FPP-5000-TI je razširitev kompleta zunanje napajalne enote FPP-5000 (24 V/6 A). Ta modul skrbi za prenos sporočil o trajni prekinitvi napajanja ali okvari akumulatorja protipožarni nadzorni plošči prek omrežja LSN (lokalno varno omrežje). Za javljanje dveh sporočil o napaki skrbita ustrezna izhoda modula za nadzor akumulatorja BCM-0000-B. Modul je neposredno povezan s podatkovnim vodilom omrežja LSN, napajanje pa poteka prek voda podatkovnega vodila omrežja LSN.

Dodelitve terminalov

Pol.	Oznake	Povezava
1	AUX1 -	Vhod za dodatno napajanje (podporne točke za zaporedno vezavo)
2	AUX1 +	
3	LSN1 a1 -	Vhod LSN
4	LSN1 b1 +	
5	SHIELD	Izoliran kabel
6	SHIELD	
7	AUX2 -	Izhod za dodatno napajanje (podporne točke za zaporedno vezavo)
8	AUX2 +	
9	LSN1 a2 -	Izhod LSN
10	LSN1 b2 +	
11	AC FAULT -	Vhod signala za trajno prekinitvev napajanja
12	AC FAULT +	
13	BATT FAULT -	Vhod signala za okvaro akumulatorja
14	BATT FAULT +	

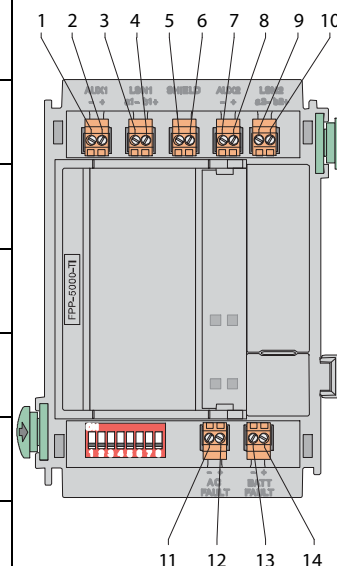

Tehnične specifikacije

Modul za opozarjanje na napake FPP-5000-TI za FPP-5000	
Vhodna napetost (min. - maks.)	+ 15 V (enosmerni tok) . . . + 33 V (enosmerni tok)
Maksimalna poraba toka	1,15 mA pri 24 V enosmernem toku (iz LSN)
Razred zaščite v skladu s standardom IEC 60529	IP 20
Dovoljena delovna temperatura	-5 °C . . . 50 °C (23 °F . . . 122 °F)
Dovoljena temperatura shranjevanja	-20 °C . . . 60 °C (-4 °F . . . 140 °F)
Relativna vlaga	Največ 95 %; brez kondenzacije
Nastavitev naslova	Z osmimi stikali DIP
Material in barva ohišja	Plastika ABS, (UL94 V-0), antracit (polsijajni), RAL 7016
Dimenzije (Š x V x D)	Pribl. 127 x 96 x 60 mm (pribl. 5,0 x 3,8 x 2,4 palcev)

Funktionsbeskrivning

FPP-5000-TI är en förlängning för FPP-5000 nätmodul 24 V/6 A.

Det ger en överföring av nät- och batterifelets signal till brandlarmscentralen via Local SecurityNetwork LSN. De två felmeddelandena tillhandahålls av motsvarande utgångar på BCM-0000-B batterimodul. Modulen är direkt ansluten till LSN-databussen och får även ström via LSN-databussledningen.

Anslutningar

Pos.	Text	Anslutning
1	AUX1 -	Ingående reservström
2	AUX1 +	
3	LSN1 a1 -	LSN Ingående
4	LSN1 b1 +	
5	SHIELD	Skärm
6	SHIELD	
7	AUX2 -	Utgående reservström
8	AUX2 +	
9	LSN1 a2 -	LSN Utgående
10	LSN1 b2 +	
11	AC FAULT -	Ingång för nätspänningsfel
12	AC FAULT +	
13	BATT FAULT -	Ingång för batterifel
14	BATT FAULT +	

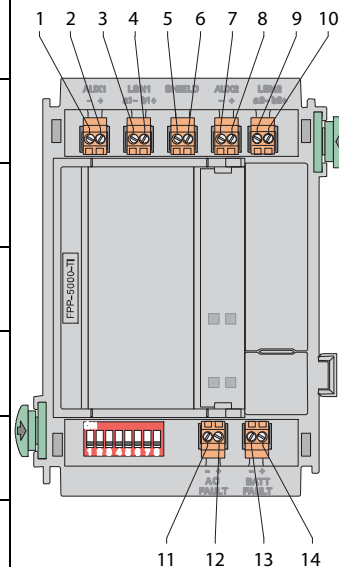

Tekniska specifikationer

FPP-5000-TI nätmodul för FPP-5000	
Spänning (min - max)	+15 V DC . . . +33 V DC
Maximal strömförbrukning	1,15 mA vid 24 V DC (från LSN)
Skyddsklass enligt IEC 60529	IP 20
Drifttemperatur	-5 °C . . . 50 °C .
Förvaringstemperatur	-20 °C . . . 60 °C .
Relativ fuktighet	Max. 95 % icke-kondenserande
Adressinställning	Via åtta DIP-brytare
Kapslingsmaterial och -färg	ABS-plast, (UL94 V-0), halvglättad antracit, RAL 7016
Mått (B x H x L)	Ca 127 x 96 x 60 mm

İşlevin Açıklaması

FPP-5000-TI, FPP-5000 Harici Güç Kaynağı Kiti 24 V/6 A ürününün bir uzantısıdır.

Yerel Güvenlik Ağı LSN üzerinden ana şebeke hatası sinyalinin ve pil hatası sinyalinin yangın paneline hata mesajı şeklinde aktarılmasını sağlar. Bu iki hata mesajı, BCM-0000-B Akü Denetleyici Modülündeki ilgili çıkışlarla sağlanır. Modül doğrudan LSN veri yoluna bağlanır ve LSN veri yolu hattından güç beslemesi yapılır.

Terminal Ataması

Konu m.	Etiketleme	Bağlantı
1	AUX1 -	Yardımcı gelen güç kaynağı (destek noktaları ile devre arasında)
2	AUX1 +	
3	LSN1 a1 -	LSN gelen
4	LSN1 b1 +	
5	SHIELD	Kablo koruyucu
6	SHIELD	
7	AUX2 -	Yardımcı giden güç kaynağı (destek noktaları ile devre arasında)
8	AUX2 +	
9	LSN1 a2 -	LSN giden
10	LSN1 b2 +	
11	AC FAULT -	Ana şebeke hatası girişi
12	AC FAULT +	
13	BATT FAULT -	Akü hatası girişi
14	BATT FAULT +	

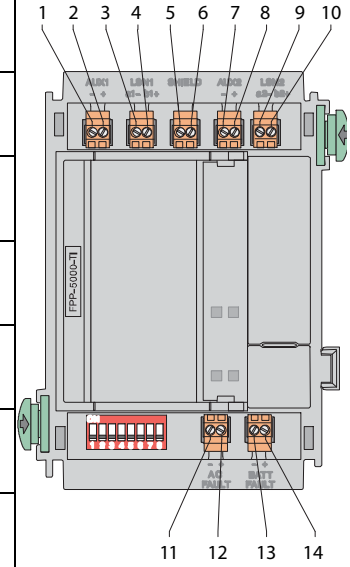

Teknik Özellikler

FPP-5000 için FPP-5000-TI Sorun Bildirme Arayüzü	
Giriş gerilimi (min - maks)	+15 V DC . . . +33 V DC
Maksimum akım tüketimi	24 V DC'de 1,15 mA (LSN'den)
IEC 60529 uyarınca koruma sınıfı	IP 20
İzin verilen çalışma sic.	-5 °C . . . 50 °C (23 °F . . . 122 °F)
İzin verilen saklama sic.	-20 °C . . . 60 °C (-4 °F . . . 140 °F)
Bağıl nem	Maks. %95, yoğunlaşmasız
Adres ayarı	Sekiz DIP anahtarı ile
Muhafaza malzemesi ve rengi	ABS plastik, (UL94 V-0), yarı parlak antrasit, RAL 7016
Boyutlar (G x Y x U)	Yaklaşık 127 x 96 x 60 mm (yaklaşık 5,0 x 3,8 x 2,4 inç)

Bosch Sicherheitssysteme GmbH

Robert-Koch-Straße 100

D-85521 Ottobrunn

Germany

Telefon 089 6290-0

Fax 089 6290-1020

www.boschsecurity.com

© Bosch Sicherheitssysteme GmbH, 2009