



LSN Communication Interface FPP-5000

FPP-5000-TI13



BOSCH

Installation

cs český

de deutsch

el ελληνικά

en english

es español

fr français

hr hrvatski

hu magyarul

it italiano

nl dutch

pl polski

pt portuguese

ro român

ru русский

sl slovenščina

tr türkçe

cs český	Popis funkcí	11
de deutsch	Funktionsbeschreibung	12
el ελληνικά	Περιγραφή λειτουργίας	13
en english	Functional Description	14
es español	Descripción funcional	15
fr français	Description fonctionnelle	16
hr hrvatski	Opis funkcija	17
hu magyarul	A működés ismertetése	18
it italiano	Descrizione delle funzioni	19
nl dutch	Functionele Omschrijving	20
pl polski	Opis działania	21
pt portuguese	Descrição funcional	22
ro română	Descrierea funcțională	23
ru русский	Принцип действия	24
sl slovenščina	Funkcionalni opis	25
tr türkçe	İşlev Açıklaması	26

Graphics

U	15 - 33 V DC
I/24 V	13.2 mA
I/LSN	3.25 mA
∅	0.2 - 1.5 mm
🌡️	-5 ... +50 °C
EN 60529	IP20
🍃	95 %
🏺	~154 g
📏	127 x 96 x 60 mm

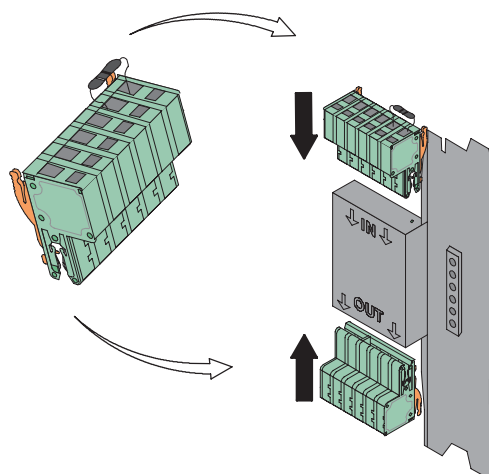
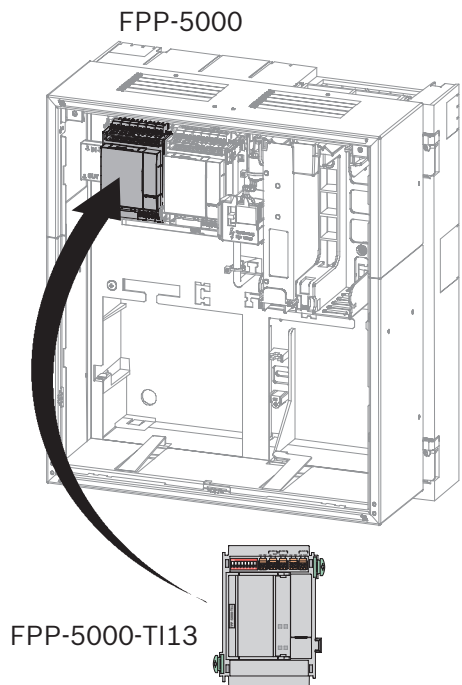

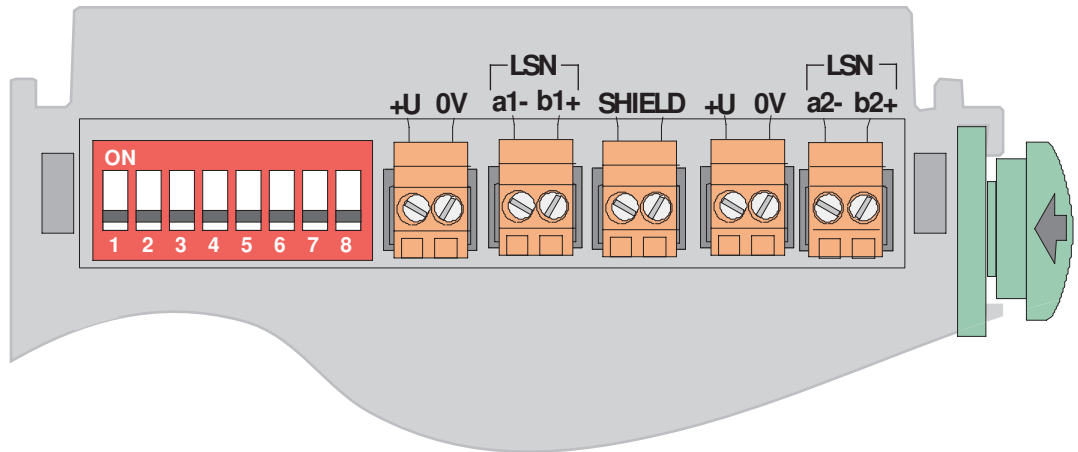
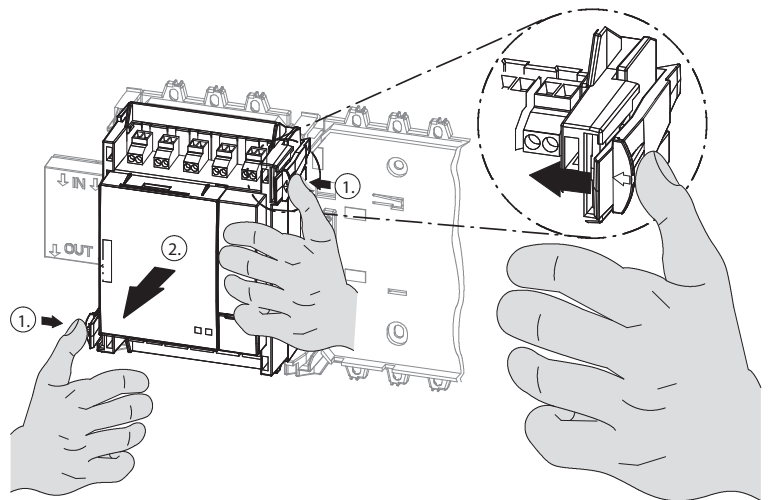
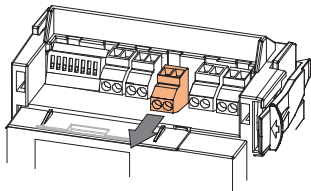
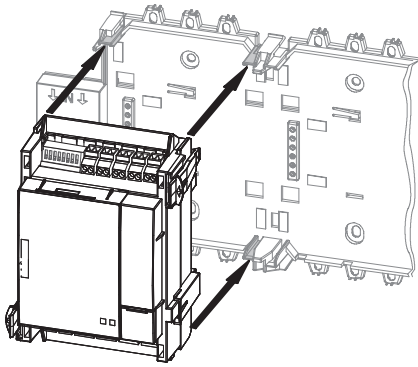

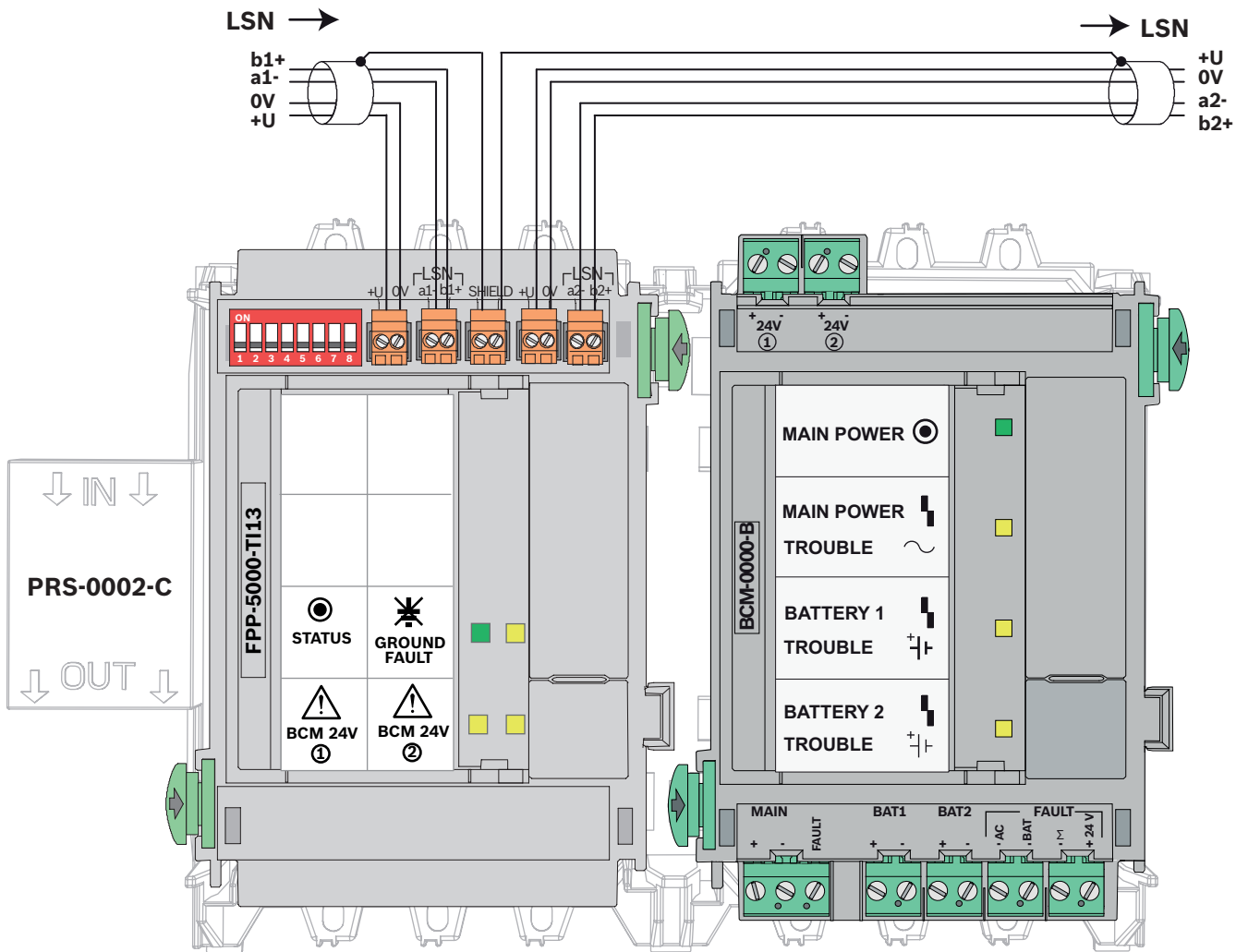

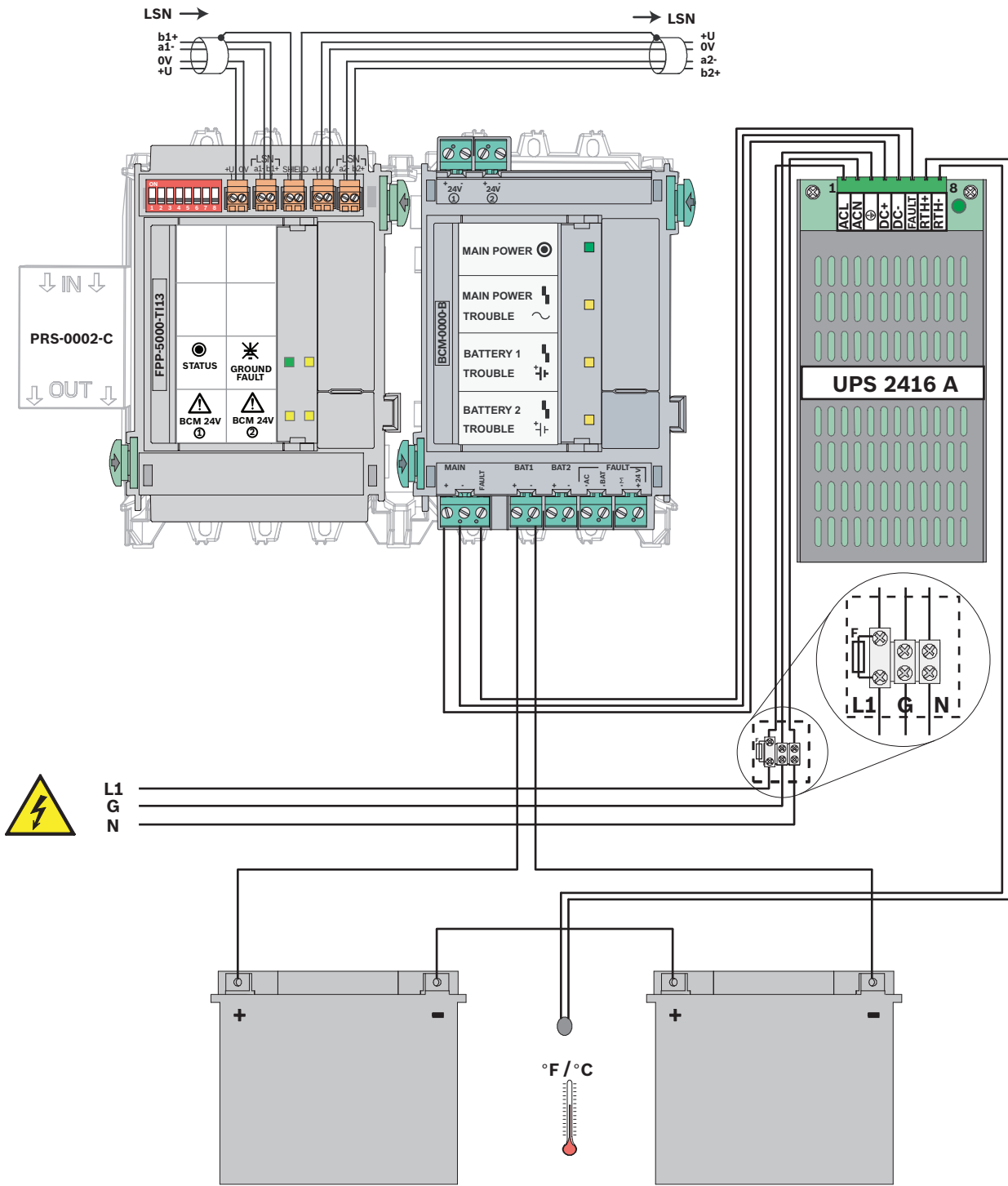

	FPA-5000	BZ 500 LSN UEZ 2000 LSN UGM 2020
0 (LSN improved)	X	-
1 - 254 (LSN improved)	X	-
255 CL = LSN classic	X	-

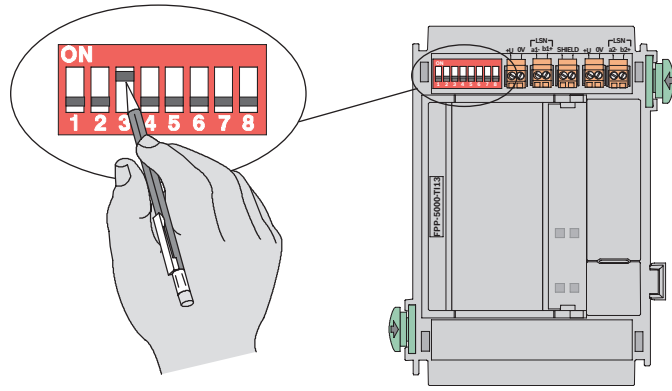

LSN improved

CL = LSN classic

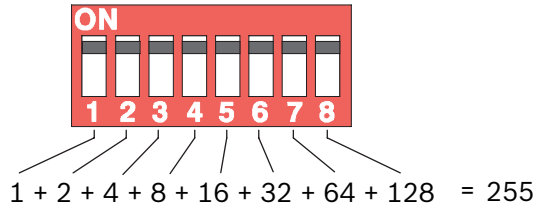
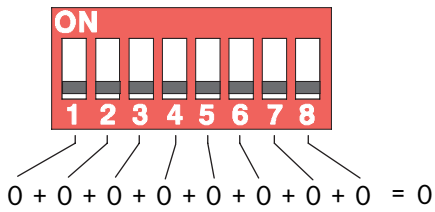

LSN 1 - 254

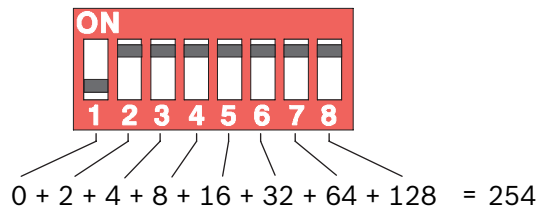
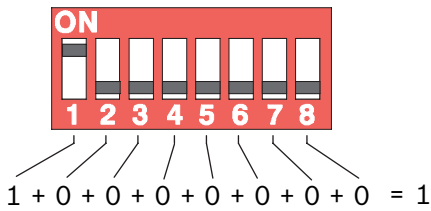



	1	2	3	4	5	6	7	8
A	1	2	3	4	5	6	7	8
LSNi=0	0	0	0	0	0	0	0	0
1	1	0	0	0	0	0	0	0
2	0	1	0	0	0	0	0	0
3	1	1	0	0	0	0	0	0
4	0	0	1	0	0	0	0	0
5	1	0	1	0	0	0	0	0
6	0	1	1	0	0	0	0	0
7	1	1	1	0	0	0	0	0
8	0	0	0	1	0	0	0	0
9	1	0	0	1	0	0	0	0
10	0	1	0	1	0	0	0	0
11	1	1	0	1	0	0	0	0
12	0	0	1	1	0	0	0	0
13	1	0	1	1	0	0	0	0
14	0	1	1	1	0	0	0	0
15	1	1	1	1	0	0	0	0
16	0	0	0	0	1	0	0	0
17	1	0	0	0	1	0	0	0
18	0	1	0	0	1	0	0	0
19	1	1	0	0	1	0	0	0
20	0	0	1	0	1	0	0	0
21	1	0	1	0	1	0	0	0
22	0	1	1	0	1	0	0	0
23	1	1	1	0	1	0	0	0
24	0	0	0	1	1	0	0	0
25	1	0	0	1	1	0	0	0
26	0	1	0	1	1	0	0	0
27	1	1	0	1	1	0	0	0
28	0	0	1	1	1	0	0	0
29	1	0	1	1	1	0	0	0
30	0	1	1	1	1	0	0	0
31	1	1	1	1	1	0	0	0
32	0	0	0	0	0	1	0	0
33	1	0	0	0	0	1	0	0
34	0	1	0	0	0	1	0	0
35	1	1	0	0	0	1	0	0
36	0	0	1	0	0	1	0	0
37	1	0	1	0	0	1	0	0
38	0	1	1	0	0	1	0	0
39	1	1	1	0	0	1	0	0
40	0	0	0	1	0	1	0	0
41	1	0	0	1	0	1	0	0

	1	2	3	4	5	6	7	8
A	1	2	3	4	5	6	7	8
42	0	1	0	1	0	1	0	0
43	1	1	0	1	0	1	0	0
44	0	0	1	1	0	1	0	0
45	1	0	1	1	0	1	0	0
46	0	1	1	1	0	1	0	0
47	1	1	1	1	0	1	0	0
48	0	0	0	0	1	1	0	0
49	1	0	0	0	1	1	0	0
50	0	1	0	0	1	1	0	0
51	1	1	0	0	1	1	0	0
52	0	0	1	0	1	1	0	0
53	1	0	1	0	1	1	0	0
54	0	1	1	0	1	1	0	0
55	1	1	1	0	1	1	0	0
56	0	0	0	1	1	1	0	0
57	1	0	0	1	1	1	0	0
58	0	1	0	1	1	1	0	0
59	1	1	0	1	1	1	0	0
60	0	0	1	1	1	1	0	0
61	1	0	1	1	1	1	0	0
62	0	1	1	1	1	1	0	0
63	1	1	1	1	1	1	0	0
64	0	0	0	0	0	0	1	0
65	1	0	0	0	0	0	1	0
66	0	1	0	0	0	0	1	0
67	1	1	0	0	0	0	1	0
68	0	0	1	0	0	0	1	0
69	1	0	1	0	0	0	1	0
70	0	1	1	0	0	0	1	0
71	1	1	1	0	0	0	1	0
72	0	0	0	1	0	0	1	0
73	1	0	0	1	0	0	1	0
74	0	1	0	1	0	0	1	0
75	1	1	0	1	0	0	1	0
76	0	0	1	1	0	0	1	0
77	1	0	1	1	0	0	1	0
78	0	1	1	1	0	0	1	0
79	1	1	1	1	0	0	1	0
80	0	0	0	0	1	0	1	0
81	1	0	0	0	1	0	1	0
82	0	1	0	0	1	0	1	0
83	1	1	0	0	1	0	1	0

	1	2	3	4	5	6	7	8
A	1	2	3	4	5	6	7	8
84	0	0	1	0	1	0	1	0
85	1	0	1	0	1	0	1	0
86	0	1	1	0	1	0	1	0
87	1	1	1	0	1	0	1	0
88	0	0	0	1	1	0	1	0
89	1	0	0	1	1	0	1	0
90	0	1	0	1	1	0	1	0
91	1	1	0	1	1	0	1	0
92	0	0	1	1	1	0	1	0
93	1	0	1	1	1	0	1	0
94	0	1	1	1	1	0	1	0
95	1	1	1	1	1	0	1	0
96	0	0	0	0	0	1	1	0
97	1	0	0	0	0	1	1	0
98	0	1	0	0	0	1	1	0
99	1	1	0	0	0	1	1	0
100	0	0	1	0	0	1	1	0
101	1	0	1	0	0	1	1	0
102	0	1	1	0	0	1	1	0
103	1	1	1	0	0	1	1	0
104	0	0	0	1	0	1	1	0
105	1	0	0	1	0	1	1	0
106	0	1	0	1	0	1	1	0
107	1	1	0	1	0	1	1	0
108	0	0	1	1	0	1	1	0
109	1	0	1	1	0	1	1	0
110	0	1	1	1	0	1	1	0
111	1	1	1	1	0	1	1	0
112	0	0	0	0	1	1	1	0
113	1	0	0	0	1	1	1	0
114	0	1	0	0	1	1	1	0
115	1	1	0	0	1	1	1	0
116	0	0	1	0	1	1	1	0
117	1	0	1	0	1	1	1	0
118	0	1	1	0	1	1	1	0
119	1	1	1	0	1	1	1	0
120	0	0	0	1	1	1	1	0
121	1	0	0	1	1	1	1	0
122	0	1	0	1	1	1	1	0
123	1	1	0	1	1	1	1	0
124	0	0	1	1	1	1	1	0
125	1	0	1	1	1	1	1	0

A								
	1	2	3	4	5	6	7	8
126	0	1	1	1	1	1	1	0
127	1	1	1	1	1	1	1	0
128	0	0	0	0	0	0	0	1
129	1	0	0	0	0	0	0	1
130	0	1	0	0	0	0	0	1
131	1	1	0	0	0	0	0	1
132	0	0	1	0	0	0	0	1
133	1	0	1	0	0	0	0	1
134	0	1	1	0	0	0	0	1
135	1	1	1	0	0	0	0	1
136	0	0	0	1	0	0	0	1
137	1	0	0	1	0	0	0	1
138	0	1	0	1	0	0	0	1
139	1	1	0	1	0	0	0	1
140	0	0	1	1	0	0	0	1
141	1	0	1	1	0	0	0	1
142	0	1	1	1	0	0	0	1
143	1	1	1	1	0	0	0	1
144	0	0	0	0	1	0	0	1
145	1	0	0	0	1	0	0	1
146	0	1	0	0	1	0	0	1
147	1	1	0	0	1	0	0	1
148	0	0	1	0	1	0	0	1
149	1	0	1	0	1	0	0	1
150	0	1	1	0	1	0	0	1
151	1	1	1	0	1	0	0	1
152	0	0	0	1	1	0	0	1
153	1	0	0	1	1	0	0	1
160	0	0	0	0	0	1	0	1
161	0	1	0	0	0	1	0	1
162	0	1	0	0	0	1	0	1
163	1	1	0	0	0	1	0	1
164	0	0	1	0	0	1	0	1
165	1	0	1	0	0	1	0	1
166	0	1	1	0	0	1	0	1
167	1	1	1	0	0	1	0	1
168	0	0	0	1	0	1	0	1
169	1	0	0	1	0	1	0	1
170	0	1	0	1	0	1	0	1
171	1	1	0	1	0	1	0	1
172	0	0	1	1	0	1	0	1
173	1	0	1	1	0	1	0	1

A								
	1	2	3	4	5	6	7	8
174	0	1	1	1	0	1	0	1
175	1	1	1	1	0	1	0	1
176	0	0	0	0	1	1	0	1
177	1	0	0	0	1	1	0	1
178	0	1	0	0	1	1	0	1
179	1	1	0	0	1	1	0	1
180	0	0	1	0	1	1	0	1
181	1	0	1	0	1	1	0	1
182	0	1	1	0	1	1	0	1
183	1	1	1	0	1	1	0	1
184	0	0	0	1	1	1	0	1
185	1	0	0	1	1	1	0	1
186	0	1	0	1	1	1	0	1
187	1	1	0	1	1	1	0	1
188	0	0	1	1	1	1	0	1
189	1	0	1	1	1	1	0	1
190	0	1	1	1	1	1	0	1
191	1	1	1	1	1	1	0	1
192	0	0	0	0	0	0	1	1
193	1	0	0	0	0	0	1	1
194	0	1	0	0	0	0	1	1
195	1	1	0	0	0	0	1	1
196	0	0	1	0	0	0	1	1
197	1	0	1	0	0	0	1	1
198	0	1	1	0	0	0	1	1
199	1	1	1	0	0	0	1	1
200	0	0	0	1	0	0	1	1
201	1	0	0	1	0	0	1	1
202	0	1	0	1	0	0	1	1
203	1	1	0	1	0	0	1	1
204	0	0	1	1	0	0	1	1
205	1	0	1	1	0	0	1	1
206	0	1	1	1	0	0	1	1
207	1	1	1	1	0	0	1	1
208	0	0	0	0	1	0	1	1
209	1	0	0	0	1	0	1	1
210	0	1	0	0	1	0	1	1
211	1	1	0	0	1	0	1	1
212	0	0	1	0	1	0	1	1
213	1	0	1	0	1	0	1	1
214	0	1	1	0	1	0	1	1
215	1	1	1	0	1	0	1	1

A								
	1	2	3	4	5	6	7	8
216	0	0	0	1	1	0	1	1
217	1	0	0	1	1	0	1	1
218	0	1	0	1	1	0	1	1
219	1	1	0	1	1	0	1	1
220	0	0	1	1	1	0	1	1
221	1	0	1	1	1	0	1	1
222	0	1	1	1	1	0	1	1
223	1	1	1	1	1	0	1	1
224	0	0	0	0	0	1	1	1
225	1	0	0	0	0	1	1	1
226	0	1	0	0	0	1	1	1
227	1	1	0	0	0	1	1	1
228	0	0	1	0	0	1	1	1
229	1	0	1	0	0	1	1	1
230	0	1	1	0	0	1	1	1
231	1	1	1	0	0	1	1	1
232	0	0	0	1	0	1	1	1
233	1	0	0	1	0	1	1	1
234	0	1	0	1	0	1	1	1
235	1	1	0	1	0	1	1	1
236	0	0	1	1	0	1	1	1
237	1	0	1	1	0	1	1	1
238	0	1	1	1	0	1	1	1
239	1	1	1	1	0	1	1	1
240	0	0	0	0	1	1	1	1
241	1	0	0	0	1	1	1	1
242	0	1	0	0	1	1	1	1
243	1	1	0	0	1	1	1	1
244	0	0	1	0	1	1	1	1
245	1	0	1	0	1	1	1	1
246	0	1	1	0	1	1	1	1
247	1	1	1	0	1	1	1	1
248	0	0	0	1	1	1	1	1
249	1	0	0	1	1	1	1	1
250	0	1	0	1	1	1	1	1
251	1	1	0	1	1	1	1	1
252	0	0	1	1	1	1	1	1
253	1	0	1	1	1	1	1	1
254	0	1	1	1	1	1	1	1
255=CL	1	1	1	1	1	1	1	1

1 Popis funkcí

Komunikační rozhraní LSN FPP-5000-TI13 představuje pouze rozšíření pro sadu externího napájecího zdroje FPP-5000. Jde o komunikační rozhraní mezi sadou FPP-5000 a ústřednou, které vysílá do ústředny následující signalizace poruch:

- Porucha elektrické sítě
- Porucha akumulátoru
- Porucha vnitřního odporu baterie
- Porucha řídicí jednotky akumulátorů BCM-0000-B
- Zkrat na 24 V výstupech
- Chybné uzemnění





S programovacím softwarem FSP-5000-RPS lze navíc naprogramovat výstupy spínače a nastavit sledování linky podle normy EN 54-13.

Modul je zapojen vedle jednotky BCM-0000-B na krátké sběrnici ústředny PRS-0002-C a je napájen sběrnici ústředny prostřednictvím sběrnice modulu (MOB). Na přední straně modulu jsou 4 indikátory LED, které signalizují činnost a chybový stav.

2 Přiřazení vývodů a indikátorů LED

Viz *Graphics, Strana 000*.

Označení	Připojení
+U/0V	1× přívod pomocného napájení (připojovací svorky pro průchozí zapojení) 1× výstup pomocného napájení (připojovací svorky pro průchozí zapojení)
a1-/b1+	Přívodní LSN
SHIELD	Stíněný vodič
a2-/b2+	Výstupní LSN

Označení	Indikátor LED zapnut	Indikátor LED vypnut	Označení	Indikátor LED zapnut	Indikátor LED vypnut
 STATUS	V činnosti	Nečinný	 GROUND FAULT	Zjištěna porucha uzemnění	Bez poruchy uzemnění
 BCM 24V ①	- Zjištěn plíživý zkrat - Přetížení => POWER OUT1 vypnut	Žádné poruchy	 BCM 24V ②	- Zjištěn plíživý zkrat - Přetížení => POWER OUT2 vypnut	Žádné poruchy

3 Technické údaje

Viz *Graphics, Strana 000*

1 Funktionsbeschreibung

Die FPP-5000-TI13 LSN-Kommunikationsschnittstelle ist ausschließlich eine Erweiterung für den FPP-5000 Bausatz externes Netzteil. Sie ist die Kommunikationsschnittstelle zwischen dem FPP-5000 und der Zentrale und überträgt die folgenden Störungen an die Zentrale:

- Netzstörung
- Batteriestörung
- Störung Innenwiderstand Batterie
- BCM-0000-B Störung Batteriereglermodul
- Kurzschluss der 24 V-Ausgänge
- Erdschluss





Außerdem können mit der Programmiersoftware FSP-5000-RPS die Schaltausgänge programmiert und die Einstellungen für die Leitungsüberwachung gemäß EN 54-13 vorgenommen werden.

Das Modul wird neben dem BCM-0000-B Modul auf dem kurzen Modulträger PRS-0002-C aufgesteckt und wird vom Modulträger über den Modulbus (MOB) mit Spannung versorgt. Auf der Vorderseite des Moduls befinden sich 4 LEDs zur Betriebs- und Störungsanzeige.

2 Klemmenbelegung und LED-Anzeige

Siehe *Graphics, Seite 000*.

Beschriftung	Anschluss
+U/0V	1x Zusatzspannungsversorgung, kommend (Anschlussklemmen zum Durchschleifen) 1x Zusatzspannungsversorgung, gehend (Anschlussklemmen zum Durchschleifen)
a1-/b1+	LSN kommend
SHIELD	Schirmbeidraht
a2-/b2+	LSN gehend

Beschriftung	LED ein	LED aus	Beschriftung	LED ein	LED aus
 STATUS	In Betrieb	Außer Betrieb	 GROUND FAULT	Erdschluss erkannt	Kein Erdschluss
 BCM 24V ①	- Schleichender Kurzschluss erkannt - Überstrom => POWER OUT1 ausgeschaltet	Keine Störungen	 BCM 24V ②	- Schleichender Kurzschluss erkannt - Überstrom => POWER OUT2 ausgeschaltet	Keine Störungen

3 Technische Daten

Siehe *Graphics, Seite 000*

1 Περιγραφή λειτουργίας

Η διασύνδεση επικοινωνίας LSN FPP-5000-TI13 είναι επέκταση μόνο για το εξωτερικό κιτ μονάδας τροφοδοσίας FPP-5000. Αποτελεί τη διασύνδεση επικοινωνίας μεταξύ του FPP-5000 και του πίνακα και μεταδίδει τα ακόλουθα προβλήματα στον πίνακα:

- Βλάβη κύριας τροφοδοσίας
- Βλάβη μπαταρίας
- Πρόβλημα εσωτερικής αντίστασης μπαταρίας
- Πρόβλημα δομοστοιχείου ελεγκτή μπαταρίας BCM-0000-B
- Βραχυκύκλωμα εξόδων 24 V
- Πρόβλημα γείωσης





Επιπλέον, με το λογισμικό προγραμματισμού FSP-5000-RPS, μπορούν να προγραμματιστούν οι έξοδοι διακοπής και να πραγματοποιηθούν οι ρυθμίσεις για την παρακολούθηση γραμμής, σύμφωνα με το EN 54-13.

Το δομοστοιχείο είναι συνδεδεμένο δίπλα στο BCM-0000-B στον κοντό οδηγό πίνακα PRS-0002-C και τροφοδοτείται με ρεύμα από τον οδηγό πίνακα μέσω του διαύλου δομοστοιχείου (MOB. Η μπροστινή πλευρά του δομοστοιχείου έχει 4 LED, που υποδεικνύουν την κατάσταση λειτουργίας και τα προβλήματα.

2 Εκχώρηση τερματικών και ενδείξεις LED

Βλ. Graphics, Σελίδα 000.

Σήμανση	Σύνδεση
+U/0V	1x βοηθητικό τροφοδοτικό εισερχόμενο (τερματικά σύνδεσης για βρόχο διέλευσης) 1x βοηθητικό τροφοδοτικό εξερχόμενο (τερματικά σύνδεσης για βρόχο διέλευσης)
a1-/b1+	LSN εισερχόμενο
SHIELD	Θωρακισμένο καλώδιο
a2-/b2+	LSN εξερχόμενο

Επισήμανση	LED αναμμένη	LED σβηστή	Επισήμανση	LED αναμμένη	LED σβηστή
 STATUS	Σε λειτουργία	Σε αδράνεια	 GROUND FAULT	Ανιχνεύθηκε πρόβλημα γείωσης	Κανένα πρόβλημα γείωσης
 BCM 24V ①	<ul style="list-style-type: none"> - Ανιχνεύθηκε βραχυκύκλωμα με ερπυσμό - Υπερένταση ρεύματος => απενεργοποιημένο POWER OUT1 	Κανένα πρόβλημα	 BCM 24V ②	<ul style="list-style-type: none"> - Ανιχνεύθηκε βραχυκύκλωμα με ερπυσμό - Υπερένταση ρεύματος => απενεργοποιημένο POWER OUT2 	Κανένα πρόβλημα

3 Τεχνικές προδιαγραφές

Βλ. Graphics, Σελίδα 000

1 Functional Description

The FPP-5000-TI13 LSN Communication Interface is an extension for the FPP-5000 External Power Supply Unit Kit only. It is the communication interface between the FPP-5000 and the panel, and transmits the following faults to the panel:





- Mains fault
- Battery fault
- Battery internal resistance fault
- BCM-0000-B Battery Controller Module fault
- Short 24 V outputs
- Ground fault

Additionally, with the FSP-5000-RPS programming software, the switching outputs can be programmed and the settings for the line monitoring according to EN 54-13 can be done. The module is plugged next to the BCM-0000-B on the PRS-0002-C Panel Rail Short and is power-supplied by the panel rail via the module bus (MOB). The module's front side shows 4 LEDs, which indicate the operation and fault status.

2 Terminal Assignment and LED Displays

See *Graphics*, page 4.

Labeling	Connection
+U/0V	1x auxiliary power supply incoming (connection terminals for looping through) 1x auxiliary power supply outgoing (connection terminals for looping through)
a1-/b1+	LSN incoming
SHIELD	Shield wire
a2-/b2+	LSN outgoing

Labeling	LED on	LED off	Labeling	LED on	LED off
 STATUS	In operation	Idle	 GROUND FAULT	Ground fault detected	No ground fault
 BCM 24V ①	- Creeping short detected - Over current => POWER OUT1 switched off	No faults	 BCM 24V ②	- Creeping short detected - Over current => POWER OUT2 switched off	No faults

3 Technical Specifications

See *Graphics*, page 4

1 Descripción funcional

La interfaz de comunicación LSN FPP-5000-TI13 es una extensión para el kit de fuente de alimentación externa FPP-5000 solamente. Es la interfaz entre FPP-5000 y la central, a la que transmite los fallos siguientes:

- Fallo de red
- Fallo de batería
- Fallo de resistencia interna de la batería
- Fallo del módulo controlador de baterías BCM-0000-B
- Salidas de 24 V en cortocircuito
- Avería de tierra





Además, con el software de programación FSP-5000-RPS, se pueden programar las salidas de conmutación y ajustar la configuración del control de línea según EN 54-13.

El módulo se conecta junto al BCM-0000-B en el raíl de central corto PRS-0002-C y recibe la alimentación del carril de la central mediante el bus de módulo (MOB). La parte frontal del módulo dispone de 4 LED que indican el estado de funcionamiento y los fallos.

2 Asignación de terminales e indicadores LED

Consulte la *Graphics, Página 000*.

Etiquetado	Conexión
+U/0V	1 fuente de alimentación auxiliar de entrada (terminales de conexión para dar continuidad) 1 fuente de alimentación auxiliar de salida (terminales de conexión para dar continuidad)
a1-/b1+	LSN entrante
SHIELD	Malla
a2-/b2+	LSN saliente

Etiquetado	LED encendido	LED apagado	Etiquetado	LED encendido	LED apagado
 STATUS	En funcionamiento	Inactivo	 GROUND FAULT	Fallo de tierra detectado	Sin fallo de tierra
 BCM 24V ①	- Cortocircuito progresivo detectado - Sobrecorriente => POWER OUT1 apagada	Sin fallos	 BCM 24V ②	- Cortocircuito progresivo detectado - Sobrecorriente => POWER OUT2 apagada	Sin fallos

3 Especificaciones técnicas

Consulte la *Graphics, Página 000*.

1 Description fonctionnelle

L'interface de communication LSN FPP-5000-TI13 est une extension du kit bloc d'alimentation externe FPP-5000 uniquement. Il s'agit de l'interface de communication entre le FPP-5000 et la centrale, qui transmet les défaillances suivantes à la centrale :





- Défaillance secteur
- Défaillance de la batterie
- Défaut de la résistance interne de la batterie
- BCM-0000-B Défaut du module de contrôleur de batterie
- Court-circuit aux sorties 24 V
- Alarme de défaut

En outre, le logiciel de programmation FSP-5000-RPS permet de programmer les sorties de commutation et de paramétrer la surveillance de ligne conformément à la norme EN 54-13. Le module se branche à proximité du module BCM-0000-B, sur le rail de centrale de petite dimension PRS-0002-C et est alimenté par le rail de centrale via le bus du module (MOB). Le module est équipé de 4 voyants LED à l'avant qui indiquent les états de fonctionnement et de défaut.

2 Affectation des bornes et voyants LED

Voir *Graphics, Page 000*.

Étiquetage	Connexion
+U/0V	1 alimentation auxiliaire entrante (bornes de connexion pour mise en boucle) 1 alimentation auxiliaire sortante (bornes de connexion pour mise en boucle)
a1-/b1+	LSN entrant
SHIELD	Câble blindé
a2-/b2+	LSN sortant

Étiquetage	Voyant LED activé	Voyant LED désactivé	Étiquetage	Voyant LED activé	Voyant LED désactivé
 STATUS	En fonctionnement	Inactif	 GROUND FAULT	Défaut de terre détecté	Aucun défaut de terre
 BCM 24V ①	<ul style="list-style-type: none"> - Court-circuit progressif détecté - Surintensité => POWER OUT1 désactivée 	Aucune défaillance	 BCM 24V ②	<ul style="list-style-type: none"> - Court-circuit progressif détecté - Surintensité => POWER OUT2 désactivée 	Aucune défaillance

3 Caractéristiques techniques

Voir *Graphics, Page 000*

1 Opis funkcija

Komunikacijsko sučelje FPP-5000-TI13 LSN predstavlja samo proširenje kompleta vanjske jedinice za napajanje FPP-5000. To je komunikacijsko sučelje između FPP-5000 i upravljačke ploče koje upravljačkoj ploči prenosi sljedeće pogreške:

- pogrešku u glavnom napajanju
- kvar baterije
- pogrešku u internom otporu baterije
- BCM-0000-B pogrešku modula kontrolera baterije
- Kratki spoj na 24 V izlazima
- Pogreška u uzemljenju





Osim toga, mogu se uz pomoć softvera za programiranje FSP-5000-RPS programirati uklopni izlazi te prilagoditi postavke za nadzor linije u skladu sa standardom EN 54-13.

Modul je priključen pored BCM-0000-B na kratku šinu za upravljačku ploču PRS-0002-C i napaja je šina ploče preko sabirnice modula (MOB). Na prednjoj strani modula nalaze se 4 LED indikatora koji pokazuju radni status i status pogrešaka.

2 Dodjela priključaka i LED prikazi

Pogledajte *Graphics, Stranica 000*.

Oznaka	Veza
+U/0V	1x pomoćni ulazni izvor napajanja (stezaljke za priključivanje kroz petlju) 1x pomoćni izlaz napajanja (stezaljke za priključivanje kroz petlju)
a1-/b1+	Ulazni LSN
SHIELD	Zaštita kabela
a2-/b2+	Izlazni LSN

Oznaka	Uključen LED indikator	Isključen LED indikator	Oznaka	Uključen LED indikator	Isključen LED indikator
 STATUS	U radu	U mirovanju	 GROUND FAULT	Otkrivena pogreška uzemljenja	Nema pogreške uzemljenja
 BCM 24V ①	<ul style="list-style-type: none"> - Otkriven kratki spoj puzajuće struje - Nadstruja => isključen POWER OUT1 	Nema pogrešaka	 BCM 24V ②	<ul style="list-style-type: none"> - Otkriven kratki spoj puzajuće struje - Nadstruja => isključen POWER OUT2 	Nema pogrešaka

3 Tehničke specifikacije

Pogledajte *Graphics, Stranica 000*

1 A működés ismertetése

Az FPP-5000-TI13 LSN kommunikációs interfész csak az FPP-5000 külső tápegységkészlethez használható bővítés. Ez az FPP-5000 tápegység és a központ közötti kommunikációs interfész, amely az alábbi hibajelzéseket továbbítja a központ felé:

- Tápellátási hiba
- Akkumulátorhiba
- Akkumulátor belső ellenállási hiba
- BCM-0000-B akkumulátor-ellenőrző modul hibája
- 24 V-os rövid kimenetek
- Földzárlat



Ezenkívül az FPP-5000-RPS programozószoftverrel be lehet állítani a kapcsolt kimenetet, illetve meg lehet adni a vonalfigyelés beállításait az EN 54-13 szabványnak megfelelően.

A modul a PRS-0002-C rövid központi sínen a BCM-0000-B akkumulátor-ellenőrző modul mellett van csatlakoztatva, és a tápellátását a központi sínről, a modulbuszon (MOB) keresztül kapja. A modul elülső oldalán négy 4-es LED található, amelyek a működési módot és a hibaállapotokat jelzik.

2 Csatlakozókiosztás és LED-kijelzők

Lásd: *Graphics, Oldal 000*.

Jelölés	Csatlakozás
+U/0V	1 bejövő kiegészítő tápellátás (csatlakozók a továbbkötéshez) 1 kimenő kiegészítő tápellátás (csatlakozók a továbbkötéshez)
a1-/b1+	LSN bejövő
SHIELD	Árnyékolt vezeték
a2-/b2+	LSN kimenő

Jelölés	LED bekapcsolva	LED kikapcsolva	Jelölés	LED bekapcsolva	LED kikapcsolva
 STATUS	Üzemben	Üresjáratú	 GROUND FAULT	Földzárlat észlelve	Nincs földzárlat
 BCM 24V ①	<ul style="list-style-type: none"> – Kialakuló rövidzár észlelve – Túláram => POWER OUT1 kikapcsolva 	Nincs hiba	 BCM 24V ②	<ul style="list-style-type: none"> – Kialakuló rövidzár észlelve – Túláram => POWER OUT2 kikapcsolva 	Nincs hiba

3 Műszaki adatok

Lásd: *Graphics, Oldal 000*

1 Descrizione delle funzioni

L'interfaccia di comunicazione FPP-5000-TI13 LSN è un'estensione esclusiva del kit alimentatore esterno FPP-5000. Rappresenta l'interfaccia di comunicazione tra il kit FPP-5000 e la centrale e trasmette alla centrale informazioni sui seguenti guasti:

- Guasto alimentazione
- Guasto batteria
- Guasto resistenza interna batteria
- BCM-0000-B Guasto modulo di controllo batteria
- Uscite 24 V in cortocircuito
- Guasto massa





Inoltre, con il software di programmazione FSP-5000-RPS, è possibile programmare le uscite di commutazione e configurare le linee di uscita in modalità controllata in conformità a EN 54-13.

Il modulo viene collegato accanto al BCM-0000-B sul binario corto di centrale PRS-0002-C e viene alimentato dal binario di centrale tramite il modulo bus (MOB). Sul lato anteriore del modulo sono presenti 4 LED che indicano gli stati di funzionamento e di guasto.

2 Assegnazione dei terminali e segnalazioni LED

Vedere *Graphics, Pagina 000*.

Etichettatura	Collegamento
+U/0V	Alimentazione ausiliaria 1x in entrata (morsettiera di collegamento per loop-through) Alimentazione ausiliaria 1x in uscita (morsettiera di collegamento per loop-through)
a1-/b1+	LSN in entrata
SHIELD	Cavo schermato
a2-/b2+	LSN in uscita

Etichettatura	LED acceso	LED spento	Etichettatura	LED acceso	LED spento
 STATUS	In funzione	Inattivo	 GROUND FAULT	Guasto di messa a terra rilevato	Nessun guasto di messa a terra
 BCM 24V ①	- Corto circuito parziale rilevato - Sovracorrente => POWER OUT1 spenta	Nessun guasto	 BCM 24V ②	- Corto circuito parziale rilevato - Sovracorrente => POWER OUT2 spenta	Nessun guasto

3 Specifiche tecniche

Vedere *Graphics, Pagina 000*

1 Functionele Omschrijving

De LSN communicatie-interface FPP-5000-TI13 is een uitbreiding die uitsluitend is bedoeld voor de externe voedingseenheid FPP-5000. Het is de communicatie-interface tussen de FPP-5000 en de centrale en verzendt de volgende storingen naar de centrale:

- Netspanningsstoring
- Accustoring
- Storing interne accuweerstand
- BCM-0000-B Storing accucontrollermodule
- Kortsluiting 24 V-uitgangen
- Aardfout





Bovendien kunnen met de programmeersoftware FSP-5000-RPS de schakeluitgangen worden geprogrammeerd en de lijnbewaking conform EN 54-13 worden ingesteld.

De module wordt aangesloten naast de BCM-0000-B op de korte paneelrail PRS-0002-C en krijgt voeding van de paneelrail via de modulebus (MOB). Op de voorzijde van de module bevinden zich 4 LED's die de bedrijfsstatus en storingen aangeven.

2 Klembezetting en LEDs

Zie *Graphics, Pagina 000*.

Labels	Verbinding
+U/0V	1x voeding voor randapparatuur, inkomend (aansluitklemmen voor doorlussen) 1x voeding voor randapparatuur, uitgaand (aansluitklemmen voor doorlussen)
a1-/b1+	LSN inkomend
SHIELD	Afgeschermd draad
a2-/b2+	LSN uitgaand

Labels	LED aan	LED uit	Labels	LED aan	LED uit
 STATUS	In bedrijf	Inactief	 GROUND FAULT	Aardfout gedetecteerd	Geen aardfout
 BCM 24V ①	- Kortsluiting door lekstroom gedetecteerd - Te hoge stroom => POWER OUT1 uitgeschakeld	Geen storingen	 BCM 24V ②	- Kortsluiting door lekstroom gedetecteerd - Te hoge stroom => POWER OUT2 uitgeschakeld	Geen storingen

3 Technische specificaties

Zie *Graphics, Pagina 000*

1 Opis działania

Interfejs komunikacyjny sieci LSN FPP-5000-TI13 stanowi wyłącznie rozszerzenie zestawu zasilacza zewnętrznego FPP-5000. Jest to interfejs komunikacyjny między urządzeniem FPP-5000 i centralą, przekazujący do niej informacje o następujących typach usterek:

- Usterka zasilania sieciowego
- Usterka akumulatora
- Usterka wewnętrznej rezystancji akumulatora
- Usterka modułu kontrolera akumulatora BCM-0000-B
- Zwarcie wyjść 24 V
- Usterka uziemienia





Przy pomocy aplikacji do programowania urządzenia FPP-5000-RPS można przeprowadzić modyfikację ustawień wyjść przełączających oraz funkcji monitorowania linii zgodnie z normą EN 54-13.

Moduł jest podłączany do krótkiej szyny przyłączeniowej PRS-0002-C obok modułu kontrolera akumulatora BCM-0000-B. Zasilanie jest realizowane przez szynę przyłączeniową za pośrednictwem magistrali modułu MOB. W przedniej części modułu znajdują się 4 diody LED, które sygnalizują funkcje obsługowe oraz stan usterki.

2 Diody LED i rozmieszczenie zacisków

Patrz *Graphics, Strona 000*.

Oznaczenie	Połączenie
+U/0V	1x połączenie wejściowe dodatkowego zasilacza (zaciski połączeniowe do połączeń przelotowych) 1x połączenie wyjściowe dodatkowego zasilacza (zaciski połączeniowe do połączeń przelotowych)
a1-/b1+	Połączenie wejściowe LSN
SHIELD	Żyła ekranująca
a2-/b2+	Połączenie wyjściowe LSN

Oznaczenie	Dioda LED wł.	Dioda LED wył.	Oznaczenie	Dioda LED wł.	Dioda LED wył.
 STATUS	Praca	Brak aktywności	 GROUND FAULT	Wykryto usterkę uziemienia	Brak usterki uziemienia
 BCM 24V ①	<ul style="list-style-type: none"> - Wykryto zwarcie narastające - Zbyt duże natężenie => wyjście POWER OUT1 wyłączone 	Brak usterek	 BCM 24V ②	<ul style="list-style-type: none"> - Wykryto zwarcie narastające - Zbyt duże natężenie => wyjście POWER OUT2 wyłączone 	Brak usterek

3 Dane techniczne

Patrz *Graphics, Strona 000*

1 Descrição funcional

A Interface de comunicação LSN FPP-5000-TI13 é uma extensão apenas do Kit de fonte de alimentação externa FPP-5000. Consiste na interface de comunicação entre o FPP-5000 e o painel, ao qual transmite as seguintes falhas:

- Falha de rede
- Falha de bateria
- Falha da resistência interna da bateria
- Falha do Módulo de Controlador da Bateria BCM-0000-B
- Curto-circuito nas saídas de 24 V
- Falha de terra





Além disso, com o software de programação FSP-5000-RPS, é possível programar as saídas de comutação e configurar as definições de monitorização de linhas em conformidade com a norma EN 54-13.

O módulo é ligado junto do BCM-0000-B na Calha curta de painel PRS-0002-C e alimentado pela calha do painel através do bus do módulo (MOB). A parte frontal do módulo apresenta 4 LEDs que indicam os estados de operação e falhas.

2 Atribuição de Terminais e Indicadores LED

Ver Graphics, Página 000.

Legendagem	Ligação
+U/OV	1 entrada de fonte de alimentação auxiliar (terminais de ligação para ligação em loop) 1 saída de fonte de alimentação auxiliar (terminais de ligação para ligação em loop)
a1-/b1+	LSN de entrada
SHIELD	Cabo blindado
a2-/b2+	LSN de saída

Legendagem	LED ligado	LED desligado	Legendagem	LED ligado	LED desligado
 STATUS	Em operação	Inativo	 GROUND FAULT	Detetada falha de ligação à terra	Sem falha de ligação à terra
 BCM 24V ①	<ul style="list-style-type: none"> - Detetada informação de curto-circuito - Excesso de corrente => POWER OUT1 desligado 	Sem falhas	 BCM 24V ②	<ul style="list-style-type: none"> - Detetada informação de curto-circuito - Excesso de corrente => POWER OUT2 desligado 	Sem falhas

3 Dados técnicos

Ver Graphics, Página 000

1 Descrierea funcțională

Interfața de comunicații LSN FPP-5000-TI13 este o extensie numai pentru kitul de unitate de alimentare externă FPP-5000. Acesta este interfața de comunicații între FPP-5000 și panou și transmite următoarele defecte la panou:

- Defect rețea
- Defect baterie
- Defect de rezistență internă baterie
- Defect modul controler baterie BCM-0000-B
- Ieșiri 24 V scurtcircuit
- Defect împământare





Suplimentar, cu software-ul de programare FSP-5000-RPS, ieșirile de comutare pot fi programate și se pot efectua setările pentru monitorizarea liniei conform EN 54-13.

Modulul este conectat apoi la BCM-0000-B de pe șina de montare scurtă PRS-0002-C și este alimentat de șina de montare prin magistrala modulelor (MOB). Partea frontală a modulului dispune de 4 LED-uri, care indică starea de operare și de defect.

2 Alocarea bornelor și afișajele cu LED-uri

Vezi *Graphics, Pagina 000*.

Etichetare	Conexiune
+U/0V	1 sursă de alimentare auxiliară de intrare (borne de conectare în buclă) 1 sursă de alimentare auxiliară de ieșire (borne de conectare în buclă)
a1-/b1+	LSN de intrare
SHIELD	Cablu ecranat
a2-/b2+	LSN de ieșire

Etichetare	LED aprins	LED stins	Etichetare	LED aprins	LED stins
 STATUS	În funcțiune	În repaus	 GROUND FAULT	Defect de împământare detectat	Niciun defect de împământare
 BCM 24V ①	- Scurtcircuit de conturare detectat - Supracurent => POWER OUT1 oprită	Fără defecte	 BCM 24V ②	- Scurtcircuit de conturare detectat - Supracurent => POWER OUT2 oprită	Fără defecte

3 Specificații tehnice

Vezi *Graphics, Pagina 000*

1 Принцип действия

Телекоммуникационный интерфейс LSN FPP-5000-TI13 является расширением только для комплекта внешнего источника питания FPP-5000. Это телекоммуникационный интерфейс между FPP-5000 и панелью. Он передает на панель сообщения о следующих неисправностях:

- Отказ сети электропитания
- Отказ батареи
- Отказ собственного сопротивления батареи
- BCM-0000-B Отказ модуля контроллера батареи
- Короткие 24 V выходы
- Отказ заземления

Кроме того, с помощью программного обеспечения FSP-5000-RPS можно запрограммировать переключаемые выходы и настройки мониторинга электролинии в соответствии с EN 54-13.

Модуль подключается рядом с BCM-0000-B на короткие салазки панели PRS-0002-C, питание к устройству подается с помощью салазок панели через шину модуля (MOB). На передней панели модуля расположены светодиоды 4, которые отображают ход эксплуатации и статус отказов.

2 Назначение контактов и светодиодные индикаторы

См. *Graphics, Страница 000*.

Маркировка	Соединение
+U/0V	Один дополнительный источник входного питания (соединительные клеммы для проходного подключения) Один дополнительный источник выходного питания (соединительные клеммы для проходного подключения)
a1-/b1+	LSN входное питание
SHIELD	Экранированный кабель
a2-/b2+	LSN выходное питание

Маркировка	LED вкл.	LED выкл.	Маркировка	LED вкл.	LED выкл.
 STATUS	Во время работы	Неактив.	 GROUND FAULT	Обнаружен отказ заземления	Отказ заземления отсутствует
 BCM 24V ①	– Обнаружено предполагаемое КЗ – Перегрузка => POWER OUT1 отключено	Неисправности отсутствуют	 BCM 24V ②	– Обнаружено предполагаемое КЗ – Перегрузка => POWER OUT2 отключено	Неисправности отсутствуют

3 Технические характеристики

См. *Graphics, Страница 000*

1 Funkcionalni opis

Komunikacijski vmesnik FPP-5000-TI13 LSN je razširitev le za komplet zunanje napajalne enote FPP-5000. Predstavlja komunikacijski vmesnik med napravo FPP-5000 in ploščo, kateri sporoča naslednje napake:

- Napaka v električnem omrežju
- Napaka baterije
- Napaka notranjega upora baterije
- BCM-0000-B Napaka modula za nadzor baterije
- Kratki izhodi 24 V
- Napaka na ozemljitvi





Dodatno lahko s programsko opremo FSP-5000-RPS programirate izhodna stikala in opravite nastavitve za nadzor linije v skladu s standardom EN 54-13.

Modul je poleg modula za nadzor baterije BCM-0000-B priključen na kratko vodilo plošče PRS-0002-C, ki preko vodila modula (MOB) napaja vmesniški modul. Na sprednji strani modula so 4 indikatorji LED, ki označujejo delovanje in stanje napak.

2 Dodelitev terminalov in zasloni LED

Oglejte si *Graphics, Stran 000*.

Oznake	Povezava
+U/0V	1x vhod za dodatno napajanje (priključki za zaporedno vezavo) 1x izhod za dodatno napajanje (priključki za zaporedno vezavo)
a1-/b1+	LSN (vhodni)
SHIELD	Izoliran kabel
a2-/b2+	LSN (izhodni)

Oznake	Indikator LED vklopljen	Indikator LED izklopljen	Oznake	Indikator LED vklopljen	Indikator LED izklopljen
 STATUS	V uporabi	Mirovanje	 GROUND FAULT	Zaznana napaka na ozemljitvenem kablu	Ni napake na ozemljitvenem kablu
 BCM 24V ①	<ul style="list-style-type: none"> - Zaznan delni kratki stik - Prevelik tok => izklopljen POWER OUT1 (izklop napajanja 1) 	Ni napak	 BCM 24V ②	<ul style="list-style-type: none"> - Zaznan delni kratki stik - Prevelik tok => izklopljen POWER OUT2 (izklop napajanja 2) 	Ni napak

3 Tehnične specifikacije

Oglejte si *Graphics, Stran 000*

1 İşlev Açıklaması

FPP-5000-TI13 LSN İletişim Arayüzü, yalnızca FPP-5000 Harici Güç Kaynağı Ünitesi Seti için bir uzatmadır. FPP-5000 ile panel arasındaki iletişim arayüzüdür ve aşağıdaki hataları panele aktarır:

- Ana şebeke hatası
- Batarya hatası
- Batarya dahili direnç hatası
- BCM-0000-B Batarya Kontrol Cihazı Modülü hatası
- Kısa 24 V çıkışlar
- Toprak hatası





Ayrıca, FSP-5000-RPS programlama yazılımıyla anahtarlama çıkışları programlanabilir ve hat izleme ayarları EN 54-13'e uygun şekilde yapılabilir.

Modül, PRS-0002-C Kısa Panel Rayı üzerinde BCM-0000-B modülünün yanına takılır ve panel rayı tarafından modül veriyolu (MOB) üzerinden güç sağlanır. Modülün ön tarafında, çalışma ve hata durumlarını gösteren 4 LED bulunur.

2 Terminal Atama ve LED Ekranlar

Bkz. *Graphics, Sayfa 000*.

Etiket	Bağlantı
+U/0V	1 x yardımcı güç kaynağı - gelen (loop geçişi için bağlantı terminalli) 1 x yardımcı güç kaynağı - giden (loop geçişi için bağlantı terminalli)
a1-/b1+	LSN gelen
SHIELD	Kablo koruyucu
a2-/b2+	LSN giden

Etiket	LED açık	LED kapalı	Etiket	LED açık	LED kapalı
 STATUS	Çalışmada	Boşta	 GROUND FAULT	Topraklama hatası algılandı	Topraklama hatası yok
 BCM 24V ①	- Kısa devre algılandı - Aşırı akım => POWER OUT1 kapatıldı	Hata yok	 BCM 24V ②	- Kısa devre algılandı - Aşırı akım => POWER OUT2 kapatıldı	Hata yok

3 Teknik Özellikler

Bkz. *Graphics, Sayfa 000*

Bosch Sicherheitssysteme GmbH

Robert-Bosch-Ring 5

85630 Grasbrunn

Germany

www.boschsecurity.com

© Bosch Sicherheitssysteme GmbH, 2016