

# Mounting Kit for Media Converter

FPM-5000-KMC



**BOSCH**

**cs** Instalační příručka  
**de** Installationsanleitung  
**el** Εγχειρίδιο εγκατάστασης  
**en** Installation Guide  
**es** Guía de instalación  
**fr** Guide d'installation  
**hr** Instalacijske upute  
**hu** Telepítési útmutató

**it** Guida all'installazione  
**nl** Installatiehandleiding  
**en** Instrukcja instalacji  
**pt** Manual de instalação  
**ro** Ghid de instalare  
**ru** Руководство по установке  
**sl** Priročnik za namestitev  
**tr** Kurulum Kılavuzu



<b>cs</b>	Instalační příručka	<b>4</b>
<b>de</b>	Installationsanleitung	<b>4</b>
<b>el</b>	Εγχειρίδιο εγκατάστασης	<b>4</b>
<b>en</b>	Installation Guide	<b>5</b>
<b>es</b>	Guía de instalación	<b>5</b>
<b>fr</b>	Guide d'installation	<b>5</b>
<b>hr</b>	Instalacijske upute	<b>6</b>
<b>hu</b>	Telepítési útmutató	<b>6</b>
<b>it</b>	Guida all'installazione	<b>6</b>
<b>nl</b>	Installatiehandleiding	<b>6</b>
<b>en</b>	Instrukcja instalacji	<b>5</b>
<b>pt</b>	Manual de instalação	<b>7</b>
<b>ro</b>	Ghid de instalare	<b>7</b>
<b>ru</b>	Руководство по установке	<b>8</b>
<b>sl</b>	Priročnik za namestitev	<b>8</b>
<b>tr</b>	Kurulum Kılavuzu	<b>8</b>

**CS****NEBEZPEČÍ!**

Součásti pod napětím a odizolovaný kabel! Nebezpečí úrazu elektrickým proudem. Během připojování nesmí být systém pod napětím.

**NEBEZPEČÍ!**

Laserová radiace, laserový produkt třídy 2M. Nedívejte se do paprsku. Přímou se nedívejte ani přes optické prostředky!

**POZNÁMKA!**

Podrobné informace o připojení konvenčních ústředěn k síti prostřednictvím rozhraní CAN a Ethernet naleznete v Průvodci připojením k síti, který je k dispozici ke stažení na webových stránkách [www.boschsecurity.com](http://www.boschsecurity.com).

**de****GEFAHR!**

Stromführende Bauteile und abisolierte Kabel! Verletzungsgefahr durch Stromschlag. Bei Anschlussarbeiten muss die Anlage spannungslos sein.

**GEFAHR!**

Laserstrahlung, Laserprodukt Klasse 2M. Nicht in den Strahl blicken oder mit optischen Instrumenten direkt betrachten!

Bei Einsatz des Medienkonverters F.01U.265.643 (EL1141-B0B-BH) oder F.01U.265.641 (EL1141-10B-BH) gilt:

**VORSICHT!**

Dies ist eine Einrichtung der Klasse A. Diese Einrichtung kann im Wohnbereich Funkstörungen verursachen. In diesem Fall kann vom Betreiber verlangt werden, angemessene Maßnahmen durchzuführen.

**HINWEIS!**

Genauere Informationen zur CAN- und Ethernet-Vernetzung der Brandmelderzentralen finden Sie im Handbuch zur Vernetzung. Es kann unter [www.boschsecurity.com](http://www.boschsecurity.com) heruntergeladen werden.

**el****ΚΙΝΔΥΝΟΣ!**

Εξαρτήματα με ηλεκτρική τάση και γυμνά καλώδια! Κίνδυνος τραυματισμού από ηλεκτροπληξία. Στο σύστημα δεν πρέπει να υπάρχει τάση κατά τη διάρκεια εργασιών σύνδεσης.

**ΚΙΝΔΥΝΟΣ!**

Ακτινοβολία λέιζερ, προϊόν λέιζερ κλάσης 2M. Μην κοιτάζετε τη δέσμη και μην την παρατηρείτε απευθείας με οπτικά όργανα!

**ΣΗΜΕΙΩΣΗ!**

Θα βρείτε λεπτομερείς πληροφορίες σχετικά με τη δικτύωση CAN και Ethernet στους πίνακες πυροπροστασίας στον Οδηγό δικτύωσης, διαθέσιμες για λήψη στο [www.boschsecurity.com](http://www.boschsecurity.com).

**en****DANGER!**

Live components and stripped cable! Risk of injury from electric shock. The system must be voltage-free during connection work.

**DANGER!**

Laser radiation, class 2M laser product. Do not stare into the beam or view directly with optical instruments!

If the media converter F.01U.265.643 (EL1141-B0B-BH) or F.01U.265.641 (EL1141-10B-BH) is installed, the following applies:

**CAUTION!**

This is a class A device. This device may cause radio interferences. In this case, the operator can be asked to take appropriate actions.

**NOTICE!**

You will find detailed information about the CAN and Ethernet networking of the fire panels in the Networking Guide available for download at [www.boschsecurity.com](http://www.boschsecurity.com).

**es****¡PELIGRO!**

Componentes cargados y cables desnudos. Riesgo de descargas eléctricas. El sistema debe estar desconectado de la corriente durante el proceso de instalación.

**¡PELIGRO!**

Producto láser de clase 2M, radiación láser. No mire directamente el haz láser ni lo haga tampoco a través de algún instrumento óptico

**¡NOTA!**

Encontrará información detallada acerca de CAN y red Ethernet de las centrales de incendio en la Guía de funcionamiento en red disponible para su descarga en [www.boschsecurity.com](http://www.boschsecurity.com).

**fr****DANGER !**

Composants sous tension et câbles dénudés. Risque de blessures par choc électrique. Assurez-vous que l'alimentation électrique est coupée lorsque vous effectuez les branchements de l'appareil.

**DANGER !**

Rayonnement laser, produit laser de classe 2M. Ne fixez pas le faisceau et ne l'examinez pas directement au moyen d'instruments optiques.

**REMARQUE !**

Pour plus d'informations concernant le fonctionnement en réseau CAN et Ethernet des centrales incendie, consultez le guide du fonctionnement en réseau (Networking Guide) disponible en téléchargement sur : [www.boschsecurity.com](http://www.boschsecurity.com).

**hr****OPASNOST!**

Komponente pod naponom i neizolirani kabel! Opasnost od tjelesnih povreda uslijed strujnog udara. Sustav ne smije biti pod naponom tijekom radova na priključivanju.

**OPASNOST!**

Lasersko zračenje, laserski proizvod klase 2M. Nemojte zuriti u svjetlosni snop niti ga izravno promatrati optičkim instrumentima!

**NAPOMENA!**

Detaljne informacije o CAN i Ethernet umrežavanju upravljačke ploče sustava za dojavu požara nalaze se u uputama za umrežavanje dostupnima za preuzimanje s web-stranice [www.boschsecurity.com](http://www.boschsecurity.com).

**hu****FIGYELEM!**

Feszültség alatti alkatrészek és csupasz kábel! Áramütésveszély. A rendszer a vezetékszerelési munkálatok során ne legyen feszültség alatt.

**FIGYELEM!**

Lézersugárzás, 2M osztályú lézer termék. Ne nézzen közvetlenül a sugárba vagy vizsgálja közvetlenül optikai eszközökkel!

**FIGYELEM!**

A tűzjelző központok CAN és Ethernet hálózatba kapcsolásáról részletes tájékoztatást talál a hálózatba kapcsolási útmutatóban (letölthető a [www.boschsecurity.hu](http://www.boschsecurity.hu) oldalon).

**it****PERICOLO!**

Componenti sotto tensione e cavo scoperto. Rischio di scosse elettriche. Il sistema non deve essere collegato alla presa di corrente durante le operazioni di installazione.

**PERICOLO!**

Prodotto laser di classe 2M in grado di produrre emissione di radiazioni. Non rivolgere lo sguardo verso il fascio o guardarlo direttamente con apparecchi ottici.

**NOTA!**

Informazioni più dettagliate sul collegamento in rete CAN ed Ethernet delle centrali di rivelazione incendio sono disponibili nella guida per il collegamento in rete scaricabile all'indirizzo [www.boschsecurity.com](http://www.boschsecurity.com).

**nl****GEVAAR!**

Spanningvoerende onderdelen en gestripte kabel! Gevaar voor letsel door elektrische schok. Het systeem moet spanningsloos zijn tijdens het aansluiten.

**GEVAAR!**

Laserstraal, laserproduct van klasse 2M. Niet in de straal kijken of deze rechtstreeks bekijken met optische instrumenten!

**AANWIJZING!**

In de Netwerk Guide die gedownload kan worden op [www.boschsecurity.nl](http://www.boschsecurity.nl) vindt u gedetailleerde informatie over het gebruik van de brandmeldcentrales in CAN- en Ethernet-netwerken.

**pl****DANGER!**

Elementy pod napięciem i odizolowane kable! Ryzyko porażenia prądem elektrycznym! Na czas prac instalacyjnych system należy odłączyć od zasilania.

**DANGER!**

Promieniowanie laserowe, produkt laserowy klasy 2M. Nie należy kierować wzroku na wiązkę promieniowania ani obserwować jej za pomocą przyrządów optycznych!

**NOTICE!**

Szczegółowe informacje na temat połączeń sieciowych CAN i Ethernet w centralach sygnalizacji pożaru można znaleźć w instrukcji połączeń sieciowych dostępnej do pobrania na stronie [www.boschsecurity.com](http://www.boschsecurity.com).

**pt****PERIGO!**

Componentes com corrente e cabo descarnado! Risco de lesões devido a choque eléctrico. O sistema não pode ter alimentação eléctrica durante os trabalhos de ligação.

**PERIGO!**

Produto emissor de radiação laser com laser de classe 2M. Não olhe directamente para o feixe nem utilize quaisquer instrumentos ópticos!

**NOTA!**

Poderá encontrar informações detalhadas sobre a ligação em rede CAN e Ethernet dos painéis de incêndio no manual de ligação em rede disponível para download em [www.boschsecurity.com.pt](http://www.boschsecurity.com.pt).

**ro****PERICOL!**

Componente sub tensiune și cablu neizolat! Pericol de electrocutare. Sistemul nu trebuie să fie sub tensiune electrică în timpul operațiilor de conectare.

**PERICOL!**

Radiație laser, produs laser clasa 2M. Nu priviți direct în fascicul sau direct, cu ajutorul unor instrumente optice!

**INDICATIE!**

Puteți găsi informații detaliate despre conectarea în rețea CAN și Ethernet a panourilor de detecție a incendiilor în Ghidul de Conectare în Rețea pe care îl puteți descărca de la [www.boschsecurity.com](http://www.boschsecurity.com).

**ru****ОПАСНОСТЬ!**

Оголенные провода и компоненты под напряжением! Опасность поражения электрическим током! Во время работ по подключению система должна быть обесточена.

**ОПАСНОСТЬ!**

Лазерное излучение. Лазерное изделие класса 2M. Запрещается смотреть на источник лазерного луча, в том числе с использованием оптических инструментов!

**ЗАМЕЧАНИЕ!**

Подробные сведения о сетевых функциях CAN и Ethernet пожарных панелей приведены в Руководстве по работе в сети, который можно загрузить с веб-сайта [www.boschsecurity.com](http://www.boschsecurity.com).

**sl****NEVARNOST!**

Komponente pod napetostjo in nezaščiten kabl! Nevarnost poškodb zaradi električnega udara. Med priključnimi deli mora biti napajanje sistema izklopljeno.

**NEVARNOST!**

Sevanje laserja, razred laserja 2M. V žarek ne strmite ali ga neposredno glejte z optičnimi pripomočki!

**OPOMBA!**

Podrobne informacije o povezavi protipožarnih plošč z omrežjem z vmesnikom CAN in ethernet so v priročniku za povezavo z omrežjem, ki si ga lahko prenesete s spletnega mesta [www.boschsecurity.com](http://www.boschsecurity.com).

**tr****TEHLİKE!**

Elektrik yüklü parçalar ve çıplak kablo! Elektrik çarpması sonucu yaralanma tehlikesi. Bağlantı işlemleri yapılırken sistemde gerilim olmamalıdır.

**TEHLİKE!**

Lazer radyasyonlu, sınıf 2M lazer ürünü. Işının içine doğru bakmayın veya optik araçlarla doğrudan izlemeyin!

**NOT!**

Yangın panellerinin CAN ve Ethernet ağı hakkında ayrıntılı bilgiyi [www.boschsecurity.com](http://www.boschsecurity.com) adresinden indirebileceğiniz Networking Guide (Ağ Kılavuzu) belgesinde bulabilirsiniz.



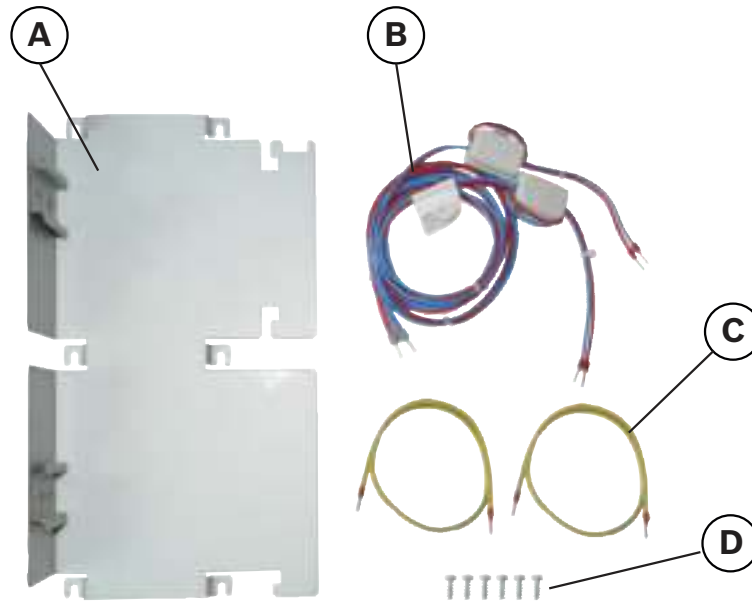
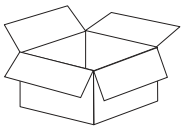

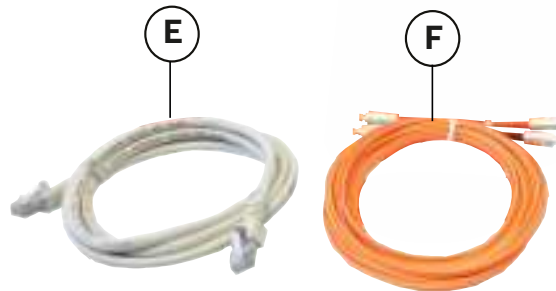
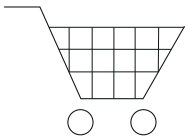

<b>A</b>	Bracket for Media Converter	<b>C</b>	⊕ 2x
<b>B</b>	MC -> BCM V- V+	<b>D</b>	KB40 x 12 (6x)

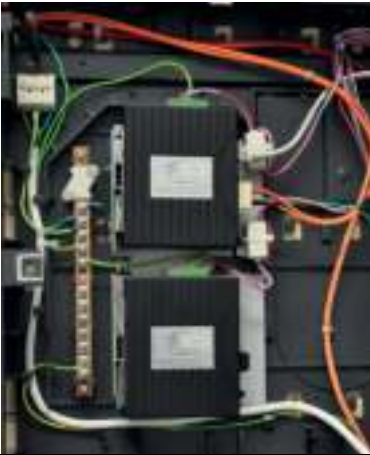

<b>E</b>	Ethernet Patch-Cable, shielded CAT5e or better	2 x RJ-45
<b>F</b>	Fiber Optic Ethernet Patch-Cable Multi-Mode: Duplex I-VH2G 50/125µ Single-Mode: Duplex I-VH2E 9/125µ	2 x SC-Connector

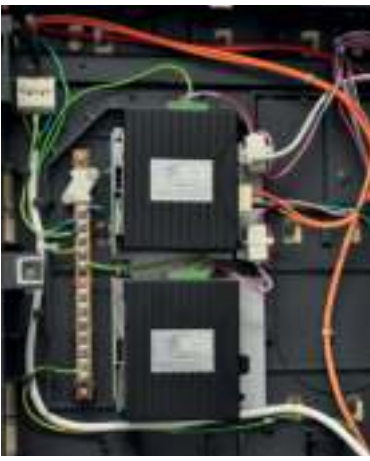
FHS 0000A 	2 x MC		--> MPC-xxxx-C
FBH 0000A 	2 x MC		--> MPC-xxxx-C

1

6 x KB40 x 12 mm

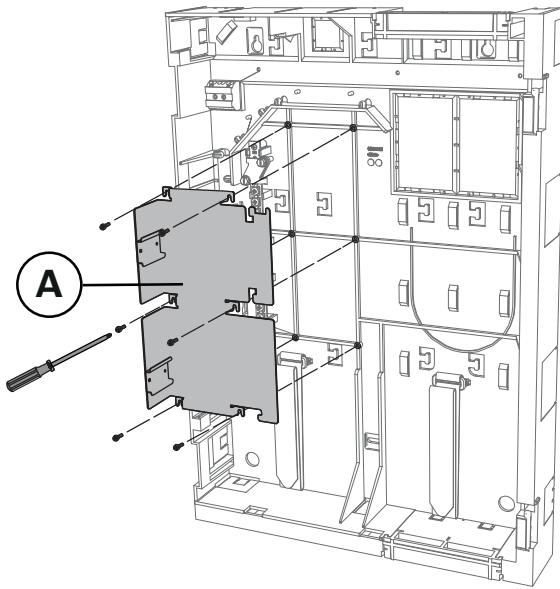

FBH 0000 A  
(FHS 0000 A)

2

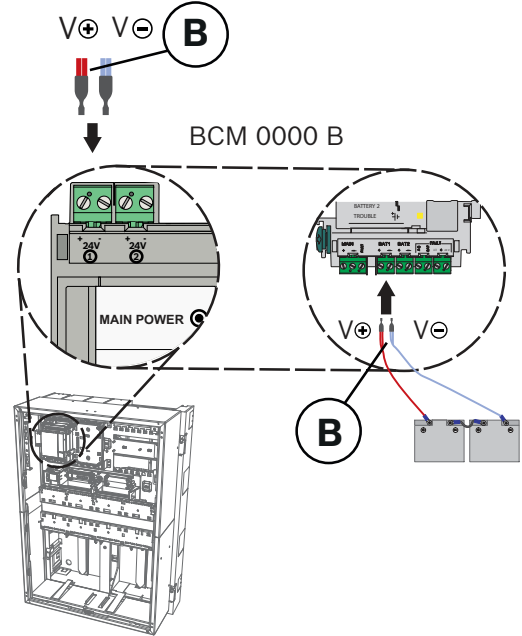

FBH 0000 A/ FHS 0000 A + CPH  
0006 A/ MPH 0010 A

3

BCM 0000 B → MPC-xxxx-C

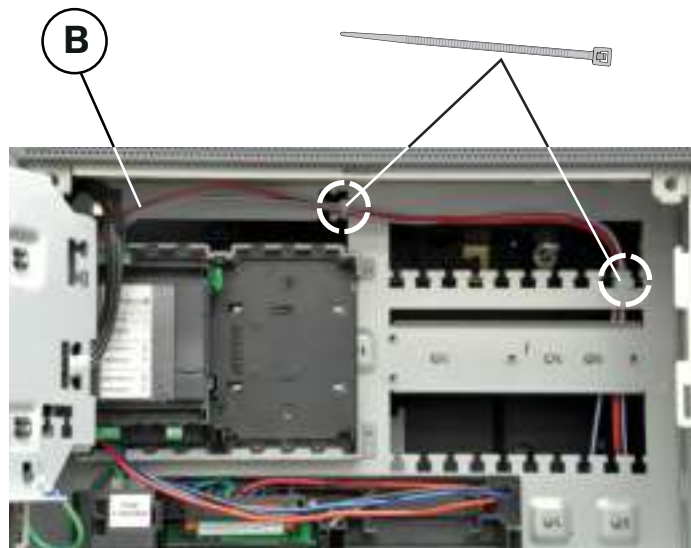

4

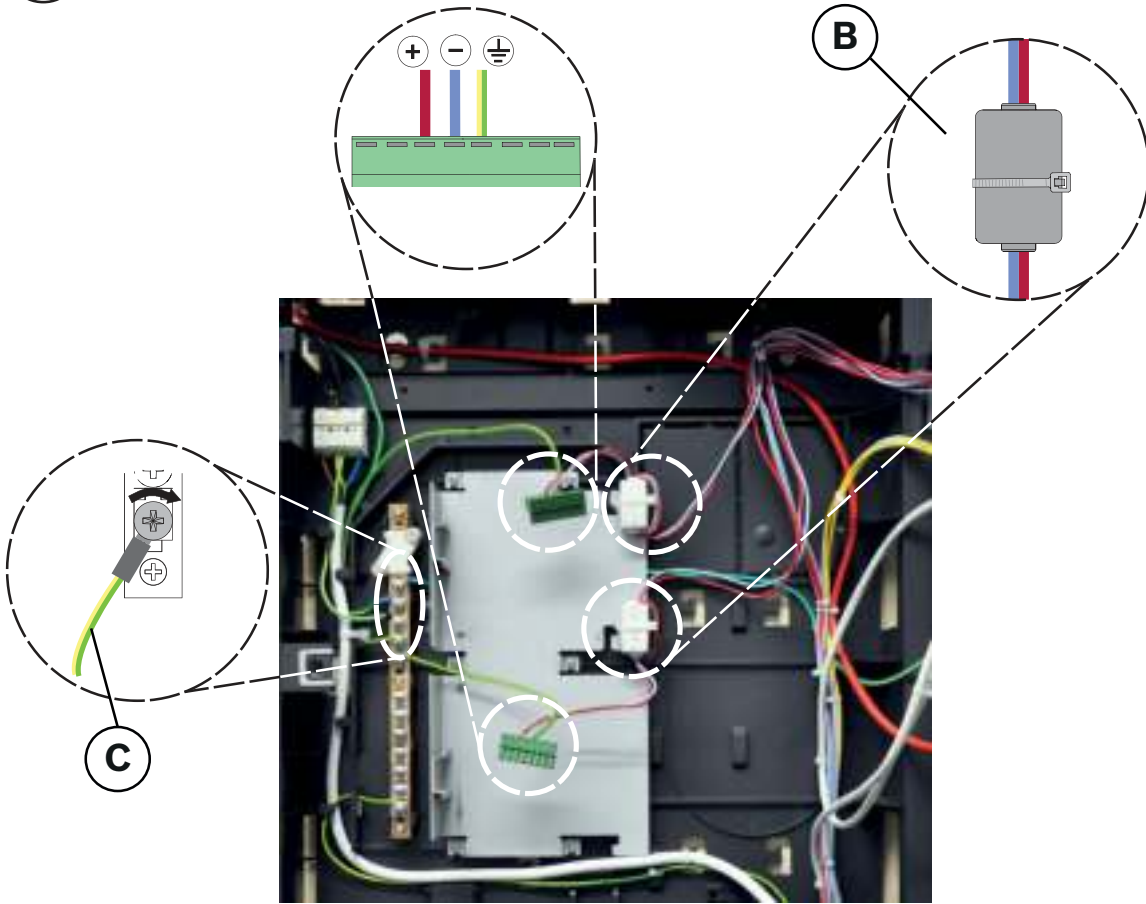

5

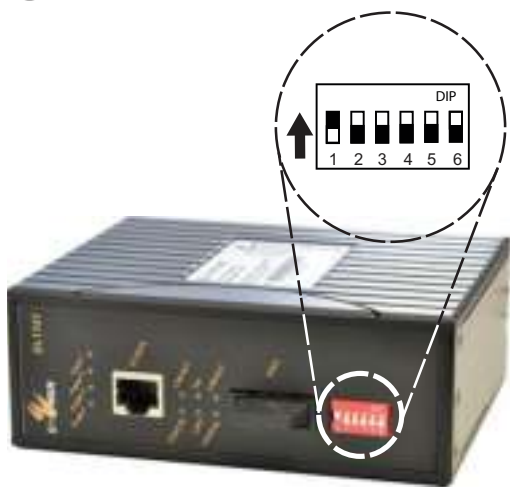

6

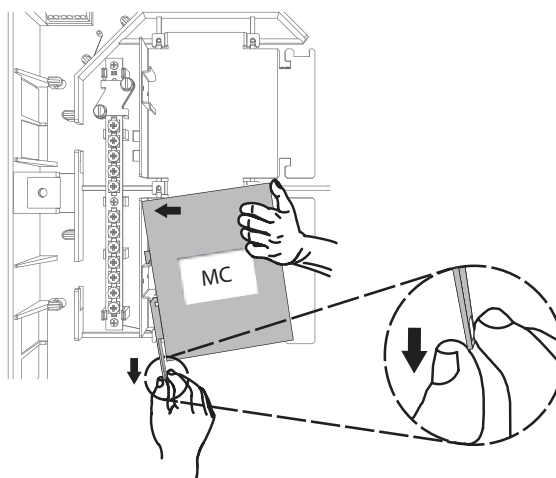

7

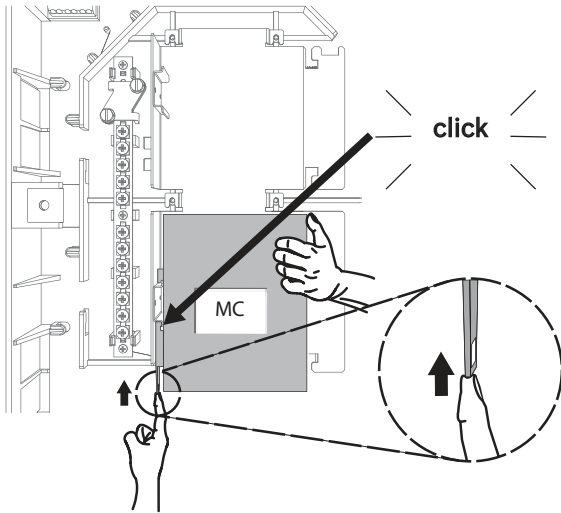

8

2 x  ↻ 5 - 7

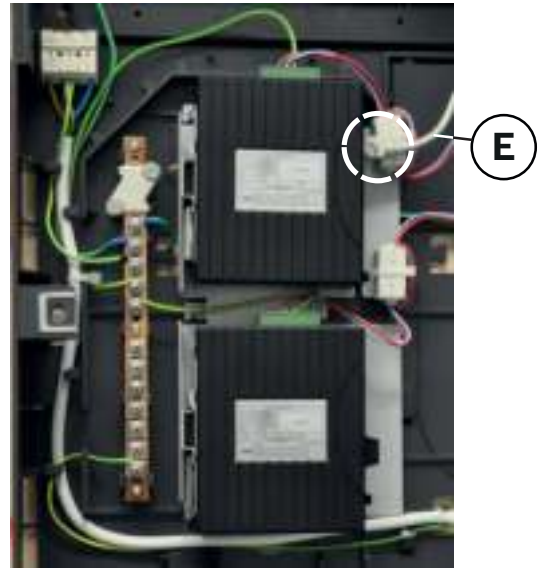

9

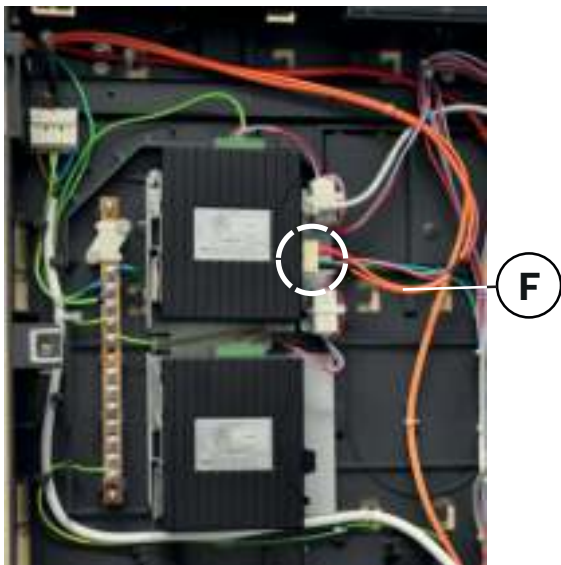

10

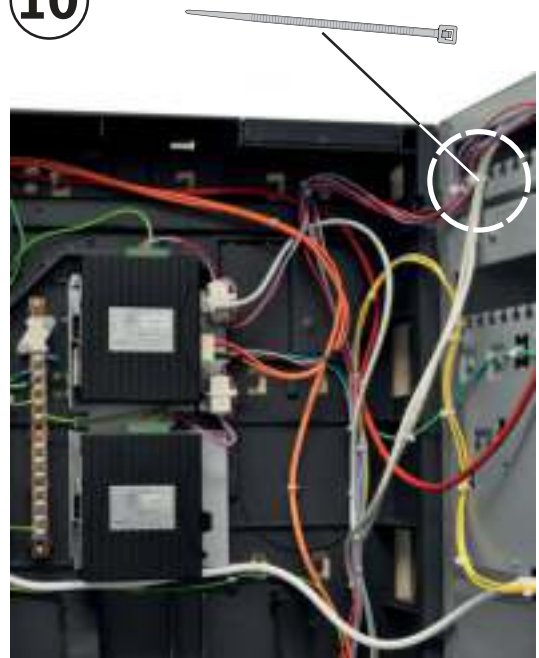

**11** MPC-xxxx-C

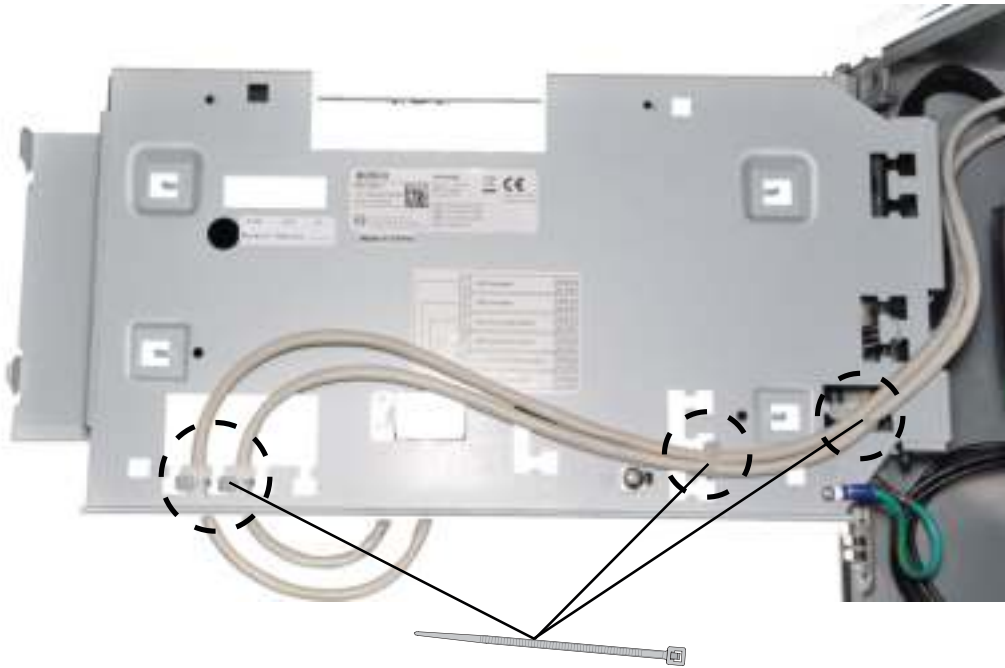

**12** MPC-xxxx-C



Ethernet Eth1   Ethernet Eth2   **E**



**Bosch Sicherheitssysteme GmbH**

Robert-Bosch-Ring 5

85630 Grasbrunn

Germany

**[www.boschsecurity.com](http://www.boschsecurity.com)**

© Bosch Sicherheitssysteme GmbH, 2012