

IP DAK-48 UNIT

EXTENSION UNIT FOR IP FLUSH MASTER STATION



when **communication** is **critical**



General

The installation of the IP DAK-48 module is different, depending on the revision of the 8031 station. The IP Master Flush Station will in this manual be referred as 8031 station

8031 stations before revision 0300

Note! Before installation, disconnect power from the 8031 station

If the DAK module is to be used with an 8031 station with revision number lower than 0300, the accompanying converter cable must be used. This cable has an RJ45 connector in one end, and one 6-way IDC and a 6-way miniature connector in the other.

Installation of first module

1. Remove the back cover for the station by loosening the 4 M3 nuts, 2 on each side.
2. Thread the 6-way IDC plug through the leftmost (when station viewed from behind) RJ45 opening in the cover.
3. Plug the 6-way IDC plug to the connector named J9 on the circuit board.
4. Remount the back cover using the 4 M3 nuts.
5. Connect the 6-way miniature plug to the matching connector on the board (J6), through the opening in the cover.
6. Plug the RJ45 end of the cable into the left hand (when module is viewed from front) RJ45 connector on the DAK module.

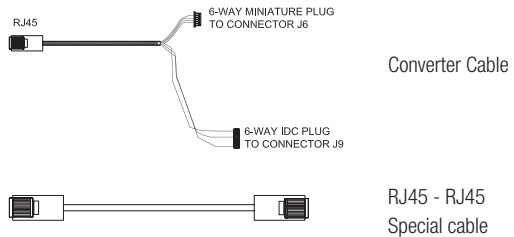
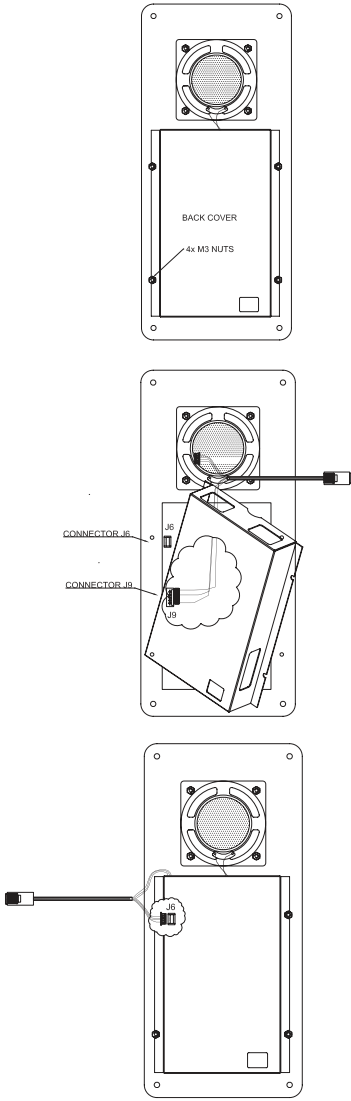

8031 Station

IP DAK 48 unit
First module

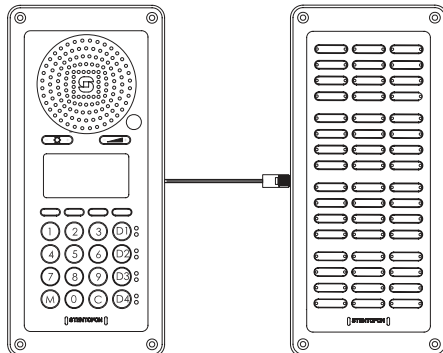

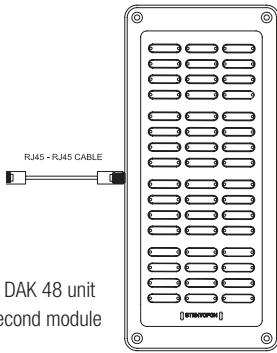

Installation of second module

1. Use the accompanying RJ45-RJ45 special cable
2. Plug one of the ends in the first installed DAK module
3. Plug the other end in the left hand (when module is viewed from front) RJ45 connector on the second DAK module.

Important Note! The RJ45 - RJ45 special cable must be used

8031 stations from revision 0300 and higher

Note! Before installation, disconnect power from the 8031 station

If the DAK module is to be used with an 8031 station with revision 0300 or higher, the accompanying RJ45-RJ45 cable must be used. This cable has an RJ45 plug in both ends. The two ends are interchangeable

Important Note! The RJ45 - RJ45 special cable must be used

Installation of modules

1. Use the accompanying RJ45-RJ45 cable
2. Plug the cables as shown in figures

8031 Station

IP DAK 48 unit
First module

IP DAK 48 unit
Second module

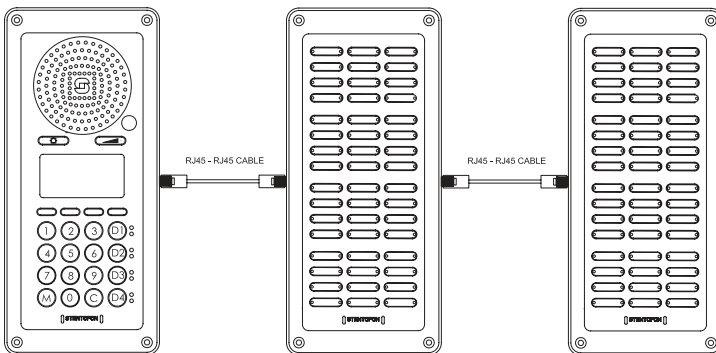

Labeling of the IP DAK-48 UNIT

Template for making text label can be downloaded from <http://www.zenitel.com/en/Stentofon/Products/Control-Center-Stations/IP-DAK-48-Unit/> Note! Normal paper can be used, special paper can be ordered from Zenitel

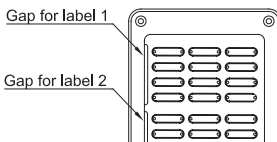

Mounting of label

1. Enter label 1 in to the gap on left hand side of the front foil
2. Continue with label 2, 3 and 4 with or without text

Zenitel Norway AS
P.O. Box 4498 Nydalen
NO-0403 OSLO
Norway

O.no. 1008098800
Backbox for handset

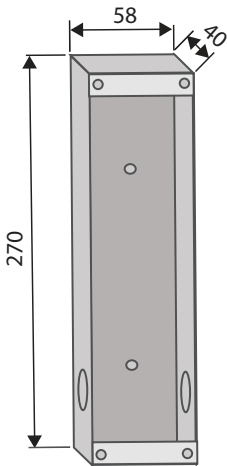

O.no. 1008098700
Flush mount back box

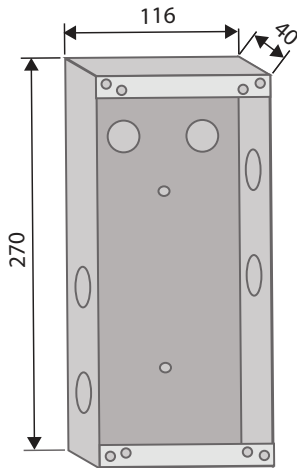

O.no. 1008098600
On wall master back box

